

**PHLSA Study Final Report
Appendix V**

Process Simulation Modeling / Equation of State Calculations

TABLE OF CONTENTS

List of Tables	iii
List of Figures	iv
Abbreviations, Acronyms, and Symbols	v
Glossary.....	vii
1.0 Introduction and Background	1
1.1 Siphon Prevention Hole in the Storage Tank Down-comer	2
1.2 Appendix V Organization	2
2.0 Approach: PSM/EOS Separator Mass Balance, FGOR, and Bubble Point Pressure Calculations	3
2.1 Separator Mass Balance Model	4
2.2 FGOR Models	5
2.3 Dead Oil Model	6
2.4 PSM/EOS Calculations of Bubble Point Pressure	7
2.5 Inputs for PSM/EOS Calculations	7
2.6 Outputs of PSM/EOS Calculations	12
3.0 Results: PSM/EOS Separator Mass Balance, FGOR, and Bubble Point Pressure Calculations	13
3.1 Separator Mass Balance Model Calculations.....	13
3.2 FGOR Models Calculations.....	14
3.3 Dead Oil Model Calculations.....	15
3.4 Bubble Point Pressure Calculations	16
4.0 FGOR Sensitivity Study	17
4.1 Sensitivity Study	17
4.1.1 Numerical Approximation Approach	17
4.1.2 Monte Carlo Simulation	20

4.2 Equation of State Models..... 22

5.0 FGOR Uncertainty 23

6.0 Conclusions and Recommendations 25

Appendix V.1 Estimated Discharge From Siphon Prevention Hole 26

Appendix V.2 PSM Instructions29

Appendix V.3 PSM/EOS Modeling Results.....32

Appendix V.4 PSM/EOS Sensitivity (Numerical Approximation Method) Study Results56

Appendix V.5 Monte Carlo Simulation Results.....82

Appendix V.6 Sim 1 Data Files

Appendix V.7 Sim 2 Data Files

Appendix V.8 Sim 3 Data Files

Appendix V.9 Sim 4 Data Files

List of Tables

2-1.	Average Operating Conditions During Winter 3-Pressure Testing Well Cycles.....	9
2-2.	Average Operating Conditions During Summer 3-Pressure Testing Well Cycles	10
2-3.	PSM/EOS Calculations Input and Output Data Engineering Units and Standard Conditions	10
2-4.	Pressurized Condensate Composition Input Data for PSM/EOS Calculations (WC S-MP3)	11
2-5.	Output Data for PSM/EOS Calculations of FGOR.....	12
2-6.	Output Composition Data for PSM/EOS Calculations of FGOR (WC S-MP3).....	13
3-1.	Example Separator Mass Balance Results	14
3-2.	Comparison of EOS Calculated FGOR to Direct Measurement FGOR	15
3-3.	Example Mass Balance Results Showing Dead Oil Volume Required to Match Direct Measurement.....	15
4-1.	Sensitivity Study for Storage Tank Conditions and Decanes Plus Properties – Numerical Approximation Approach.....	18
4-2.	Sensitivity Study for Separator Conditions and SPH Fraction – Numerical Approximation Approach.....	19
4-3.	Average Results of Sensitivity Study.....	20
4-4A.	Monte Carlo Simulation Input Data – Process Data	21
4-4B.	Monte Carlo Simulation Input Data – Analytical Data.....	21
4-5.	EOS Model Selection Results	23
5-1.	FGOR Uncertainty Calculations.....	24
5-2.	Bubble Point Uncertainty Calculations	24
5-3.	Shrinkage Factor Uncertainty Calculations.....	24

List of Figures

1-1.	Location of the siphon prevention hole on the down-comer pipe.	2
2-1.	Separator balance model PFD.	5
2-2.	“Simple” PSM/EOS model process flow diagram.	5
2-3.	“Complex” PSM/EOS model process flow diagram.	6
2-4.	Data flow for PSM/EOS calculations	8
3-1.	Phase envelope for a condensate sample tested for the PHLSA study.	17

Abbreviations, Acronyms, and Symbols

bbbl	barrel
bbbl/day	barrels per day
C10+	decanes and higher hydrocarbons
cf	cubic foot
CP	constant pressure
CV	constant volume
FGOR	flash gas-to-oil ratio
GC	gas chromatograph
GOR	Gas-to-oil ratio
GPA	Gas Processors Association
HP	high-pressure
IPT	initial pressure test
LP	low-pressure
MB100	mass balance corrected to 100%
ml	milli-liter
mole %	mole percent
MP	mid-pressure
Mscfd	thousand standard cubic feet per day
MW	molecular weight
N ₂	nitrogen
oz	ounce (ounce per square inch)
P	pressure
PFD	Process Flow Diagram
PHLSA	pressurized hydrocarbon liquid sampling and analysis
psi	pounds per square inch
psia	pounds per square inch absolute
psig	pounds per square inch gauge
PSM/EOS	Process Simulation Model / Equation of State
scf	standard cubic foot

scf/bbl	standard cubic feet per barrel
SG	specific gravity
std	standard
T	temperature
WC	well cycle
ρ	density
%	percent
$^{\circ}\text{F}$	degrees Fahrenheit

Glossary

Bubble point pressure	The bubble point pressure is the pressure (at a given temperature) at which the first bubble of gas comes out of solution in oil. For pressurized hydrocarbon liquid sampling and analysis, the bubble point pressure is typically determined at the pressurized sample collection temperature.
Down-comer line	A down-comer line is an extension of the separator to tank pipeline installed inside the tank. The line typically ends about a foot from the tank bottom. Introducing separator fluids using a down-comer line, rather than a side-fill configuration, prevents the splatter effect of incoming oil striking the tank liquid surface and reduces the rapid volatilization of light hydrocarbons.
Flash gas to oil ratio	Flash gas to oil ratio (FGOR) is the volume of flash gas, rapidly generated when a volume of oil undergoes a rapid pressure drop through a dump valve from a separator to an atmospheric oil storage tank, divided by the post-flash oil volume. FGOR can depend on the pressurized oil composition; the separator temperature and pressure; the tank temperature (liquid and headspace gas), pressure, and liquid height; the tank fluid inlet configuration (e.g., down-comer or side-fill); and other parameters. FGOR is reported as scf of flash gas per barrel of post-flash oil.
Pressurized liquids	“Pressurized Liquids” shall mean hydrocarbon liquids separated from, condensed from, or produced with natural gas while still under pressure and upstream of the Condensate tanks servicing the well.
Separator	“Separator” shall mean a pressurized vessel used for separating a well stream into gaseous and liquid components.
Shrinkage	Shrinkage is the reduction in the volume of a pressurized liquid hydrocarbon sample when the sample temperature and pressure change from separator conditions to tank conditions.
Siphon hole	A small hole near the top of a storage tank down-comer to prevent a siphon effect and backflow of liquid from the tank to the separator.
Storage tank	An atmospheric storage tank for condensate equipped with a pressure relief valve to maintain the pressure below a design threshold (e.g., 16 oz).

1. Introduction and Background

This appendix presents the results of the Process Simulation Modeling/Equation of State (PSM/EOS) calculations task for the Noble Energy PHLSA study. PSM/EOS calculations used to estimate the flash gas generated when a pressurized hydrocarbon liquid (e.g., condensate) is subjected to pressure and temperature changes as it is transferred from a pressurize vessel (typically a separator) into an atmospheric storage tank. The PHLSA study was conducted at a single production site in the DJ Basin, the Bernhardt J31-32D well, and the results presented in this appendix apply to this production site. PSM/EOS calculations for other sites may produce different results due to differences in parameters such as equipment, operating conditions, process rates and fluid properties.

The primary objectives of the PSM/EOS calculations task were to:

- identify parameters needed to calculate flash gas generation rates in condensate storage tanks using commercially available PSM/EOS programs;
- calculate flash gas generation rate estimates using the pressurized condensate compositions and process conditions for the Winter and Summer three-pressure tests;
- determine the sensitivity of calculated flash gas generation rates to these input parameters;
- estimate the uncertainty of the PSM/EOS calculations; and
- develop recommended “best practices” for PSM/EOS calculation of flash gas generation rates.

Parameters that impact storage tank flash gas generation rates and are required for PSM/EOS calculations of flashing emissions include the pressurized hydrocarbon liquid composition, and the separator and storage tank operating conditions. Pressurized liquid hydrocarbon samples are collected from the last pressurized vessel upstream of the atmospheric pressure storage tank, and analyzed using gas chromatograph (GC) methods to determine the composition (refer to Section 2.3 of the Final Report). The pressures and temperatures of the separator and storage tank used for PSM/EOS calculations should represent the operating conditions at the time of the sample collection and condensate transfer from the separator to the tank.

PSM/EOS calculations are equilibrium calculations and will estimate the volume of flash gas generated when a known volume of condensate is dumped from a separator operating at a known temperature and pressure to a storage tank operating at a known temperature and pressure. The calculations are based on the pressurized condensate sample being in gas/liquid equilibrium at the separator temperature and pressure, and the tank liquids being in gas/liquid

equilibrium at the storage tank temperature and pressure. Flashing emissions from an atmospheric storage tank are not a steady-state process because storage tank headspace gas accumulation/pressure increase and tank-to-burner gas flow are inter-dependent. Further, it has been observed that flash gas that enters a storage tank at the bottom through a down-comer does not migrate to the tank headspace at a steady rate (refer to Section 2.1 of the Final Report). Thus, it is anticipated that the flash gas to oil (FGOR) values estimated by the steady state modeling would be inputs to dynamic models used to design storage tank control systems.

1.1 Siphon Prevention Hole in the Storage Tank Down-comer

A discovery during the testing was that the storage tank down-comer pipe has a 3/8" hole near the top of the tank. This "siphon prevention hole (SPH)" was installed as a safety feature. Absent such a hole, in the event of an upset condition where a negative pressure is applied on the separator, a siphon could form and oil would flow from the tank back to the separator. The siphon prevention hole was drilled to prevent siphon formation and such back-flow. An illustration of the hole location within the tank is shown in Figure 1-1.

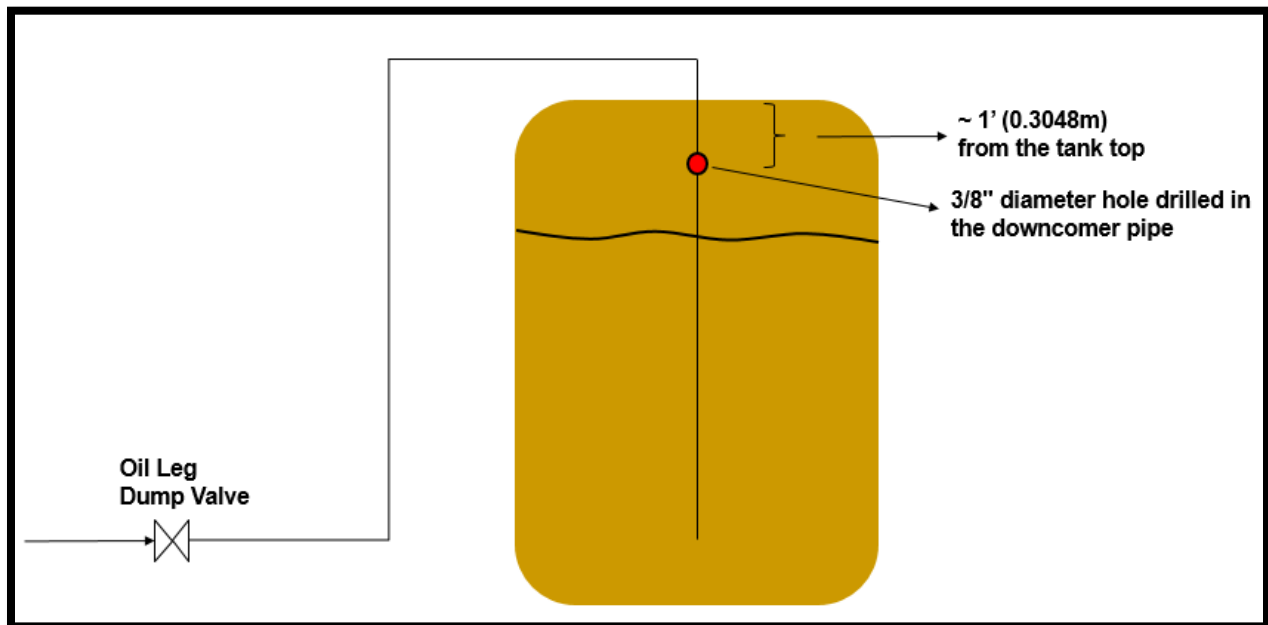

Figure 1-1. Location of the siphon prevention hole on the down-comer pipe.

A consequence of the SPH is that some of the fluids flowing from the separator to the tank pass through the siphon prevention hole into the tank headspace. The tank headspace temperature and pressure differ from the tank bottom conditions where the majority of the separator fluids are expected to flow (refer to Section 2.1 of the Final Report), and this temperature and

pressure difference would impact liquids flashing. The SPH was considered in the PSM/EOC calculations as discussed in the following. The fraction of the separator to tank fluids flow that passes through the SPH could not be directly measured, and was estimated to be 0.06 based on a simple engineering model that is presented in Appendix V.1.

1.2 Appendix V Organization

This section introduces PSM/EOC software programs and provides some background information. Section 2 describes the approach used to conduct this task including the different PSM/EOC models used to simulate the Bernhardt production site processes, and Section 3 presents the results of the PSM/EOC models calculations. Section 4 describes a PSM/EOC calculations sensitivity study (i.e., how much does an incremental change in a PSM/EOC calculation input change the outputs) and Section 5 provides estimations of the uncertainties of the PSM/EOC calculations. Section 6 then summarizes task conclusions and recommendations for conducting PSM/EOC calculations of storage tank flash gas emissions.

Appendix V.1 Estimated Discharge From Siphon Prevention Hole

Appendix V.2 PSM Instructions

Appendix V.3 PSM/EOC Modeling Results

Appendix V.4. PSM/EOC Sensitivity Study Results

Appendix V.5 Monte Carlo Simulation Results

Appendix V.6 – V9 Files with Inputs and Outputs for PSM/EOC Calculations

2. **Approach: PSM/EOC Separator Mass Balance, FGOR, and Bubble Point Pressure Calculations**

PSM/EOC estimates of FGOR generation rates were calculated using four different commercially available simulation software programs identified as Sim 1, Sim 2, Sim 3, and Sim 4. Unless otherwise noted, a Peng-Robinson equation of state was used for the equilibrium calculations. Three simulation models were conducted using the four simulation programs:

1. Separator balance. For each well cycle from the Winter and Summer three-pressure testing (refer to Final Report Section 3.2.9), measured volumes and compositions of sales gas, oil production, and water production were recombined into a single well output/separator input process stream that was input to each PSM/EOC software program. Separator sales gas, oil, and water outputs were calculated and compared to the measured volumes to check the accuracy of the software programs. Due to the high uncertainty of direct measurement in the Mass Balance ($U > 20\%$), the Separator Balance provides a secondary

means of estimating EOS uncertainty since the separator measurement uncertainty is significantly lower ($U < 5\%$).

2. FGOR. Flash gas to oil ratios and flash gas compositions were calculated for each well cycle from the Winter and Summer three-pressure testing based on the pressurized oil composition, separator pressure (P_{sep}), separator liquids temperature (T_{sep}), the pressure at the tank bottom at the down-comer exit (P_{tank}), and the temperature of the storage tank liquids at the down-comer exit (T_{tank}).
3. Dead oil. As discussed in Section 4.7 of the Final Report, directly measured storage tank mass balance closures improved as each testing day progressed and tank liquid temperatures increased. It was hypothesized that the tank oil in the vicinity of the tank down-comer had cooled over-night and was under-saturated (i.e., not at gas/liquid equilibrium), and that some of the flash gas was being absorbed by this cold oil rather than migrating to the tank headspace. To evaluate this theory, the FGOR model was modified to add a sufficient volume of dead oil to pressurized oil such that the PSM/EOS calculated FGOR equaled the directly measured FGOR.

These simulation models are discussed in greater detail in the following sub-sections.

2.1 Separator Mass Balance Model

Each PSM/EOS software program was evaluated by conducting separator balance calculations using the model shown the Process Flow Diagram (PFD) shown in Figure 2-1. For each well cycle, measured volumes and compositions of sales gas, oil production, and water production (one analysis per season) cycle, the measured volumes of sales gas (Sales_Gas), produced oil (Separator_Oil), and produced water (Separator_Water) and associated measured compositions were recombined in "Mixer 1" to form the "Well Bore Fluid". PSM/EOS calculations of separator outlet streams volumes and compositions were conducted. The measured volumes were compared to the modeled volumes to better understand the uncertainty of the PSM/EOS equilibrium calculations.

The separator mass balance model was developed using process simulation software 1 (Sim 1) and then mimicked in Sim 2 and 3. Because Sim 4 is not a graphic PSM/EOS model, recreating the separator mass balance model was not practical.

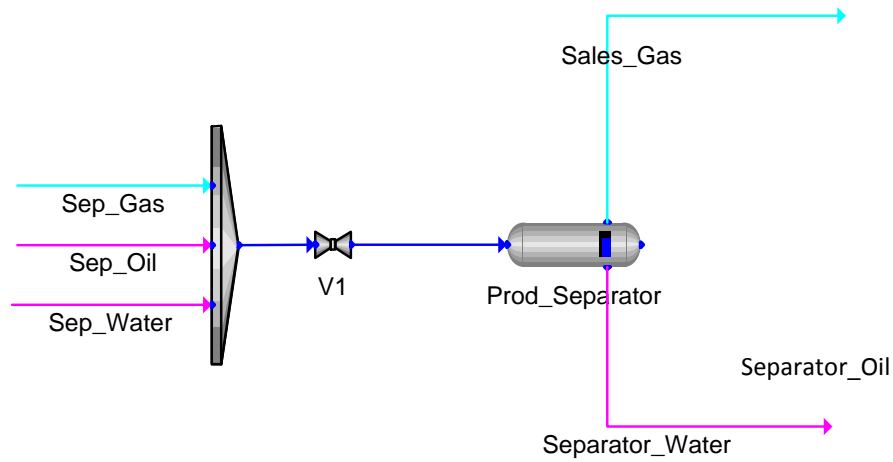

Figure 2-1. Separator balance model PFD

2.2 FGOR Models

Two PSM/EOS models were developed to calculate FGORs. The “Simple” model does not consider the siphon prevention hole discussion above and 100% of the separator to tank fluids flow is assumed to flow through the tank down-comer to the bottom of the storage tank (i.e., into the tank liquids about 1 foot from the tank bottom). Figure 2-2 is the process flow diagram for the simple model. Pressurized oil (Pressurized_Condensate) enters the storage tank and flash gas (Flash_Gas) and post-flash oil (Tank_Condensate) are the outputs.

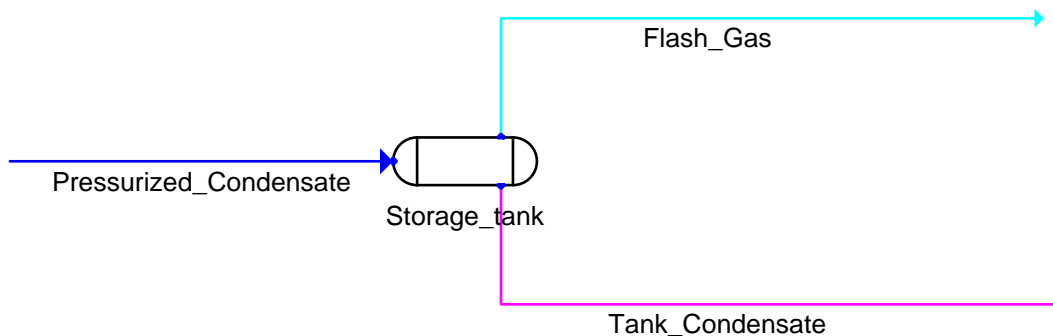

Figure 2-2. “Simple” PSM/EOS model process flow diagram.

Figure 2-3 presents the process flow for the “complex” model that evolved from the simple model. The change was to consider the impact of the siphon prevention hole in the storage tank down-comer. Pressurized oil (Oil_to_tank) enters the down-comer and splits into two streams:

1. Fluids that pass through the SPH to the storage tank headspace (Oil_to_tank_headspace). This fluid partitions to gas (Flash_Gas_from_HS) and liquid (Oil_from_SPH) in the tank headspace.
2. Fluids that pass through the entire down-comer to the tank bottom (Oil_to_Tank_bottom). This fluid partitions to gas (Flash_Gas_from_tank_bottom) and liquid (Tank_Condensate) in the tank bottom in the vicinity of the down-comer outlet.

Flash_Gas_from_HS and Flash_Gas_from_tank_bottom are mixed to determine the entire volume of flash gas (Flash_Gas). Oil_from_SPH and Tank_Condensate are mixed to determine the entire volume of post-flash tank oil (Tank_Oil).

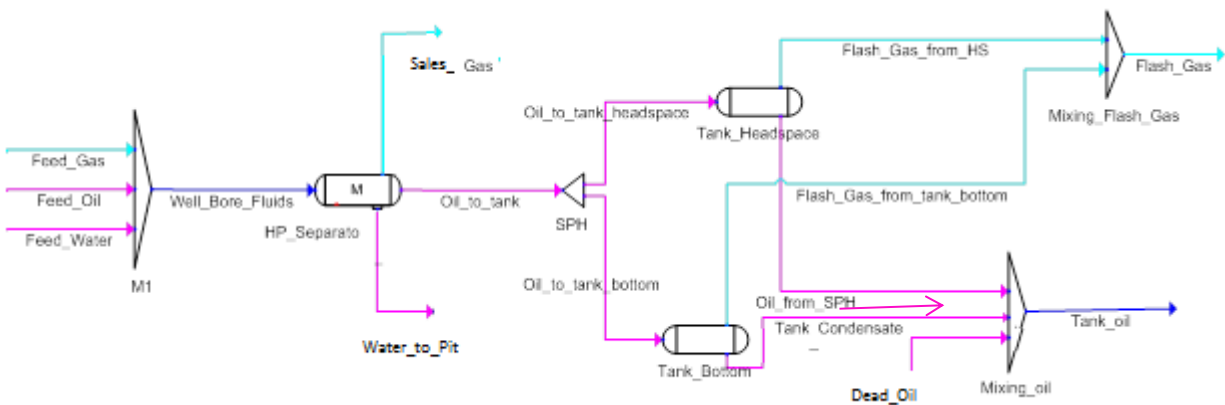

Figure 2-3. “Complex” PSM/EOS model process flow diagram.

The simple and complex models were developed using process simulation software 1 (Sim 1) and then mimicked in Sim 2 and 3. Sim 4 is similar to the simple model, with the separator condensate dumping into the tank without the additional PFD objects utilized in the complex model. Because Sim 4 is not a graphic PSM/EOS model, recreating the complex model with the SPH was not practical.

2.3 Dead Oil Model

As discussed in Section 4.7 of the Final Report, measured FGORs and storage tank mass balance closures tended to increase as the test day progressed and tank liquid temperatures increased. A theory to at least partially explain these measurements is that cold morning tank liquids were

not in gas/liquid equilibrium and some flash gas was absorbed by under-saturated “dead oil” in the bottom of the tank. Under these conditions, PSM/EOS equilibrium calculations would not be expected to agree with the storage tank emission measurements. To compensate for these non-equilibrium conditions, a “dead oil” modeling approach was used. The dead oil model added a volume of unsaturated dead oil to the flash gas simulation, and adjusted this volume such that PSM/EOS calculation results matched the Bernhardt site direct measurements of FGOR.

Similar to the models discussed above, the dead oil model was developed using Sim 1 and then mimicked in Sim 2 and 3. Because Sim 4 is not a graphic PSM/EOS model, recreating the dead oil model was not practical.

2.4 PSM/EOS Calculations of Bubble Point Pressure

The Bubble Point is the temperature and pressure where the first bubble begins to form in a liquid mixture. The determination of Bubble Point is performed at a fixed pressure (Bubble Point Pressure) or a fixed temperature (Bubble Point Temperature). It becomes useful information when the determination is done at one of the operating conditions of pressure or temperature. For Bubble Point Pressure (which was used in this study) the vapor pressure is calculated for the fluid composition at a set temperature. In the study, the temperature of the separator (Tsep) was used. The Bubble Point in this case is the pressure at a given temperature that the first gas bubble begins to form in the liquid mixture.

PSM/EOS software programs often feature special property calculations such as Dew Point and Bubble Point. The Bubble Point from EOS is used as an operational performance check to validate sample collection and analysis results. Bubble Points were also run at 72°F to compare to Initial Pressure Tests (IPT) run at that temperature. This step was added to validate the IPT as an operational performance check.

2.5 Inputs for PSM/EOS Calculations

As discussed in Section 3.3 of the Final Report, the Bernhardt test site was instrumented to measure process parameters such as separator and tank pressures and temperatures, and gas and liquid flow rates. These process measurement data (sales gas volume and composition, produced water volume and composition, and produced condensate volume), and the pressurized condensate samples’ analytical results (including the density and molecular weight of the decanes and heavier), were used as inputs for modeling the Winter and Summer three-pressure testing well cycles. Figure 2-4 provides an overview of the data flow.

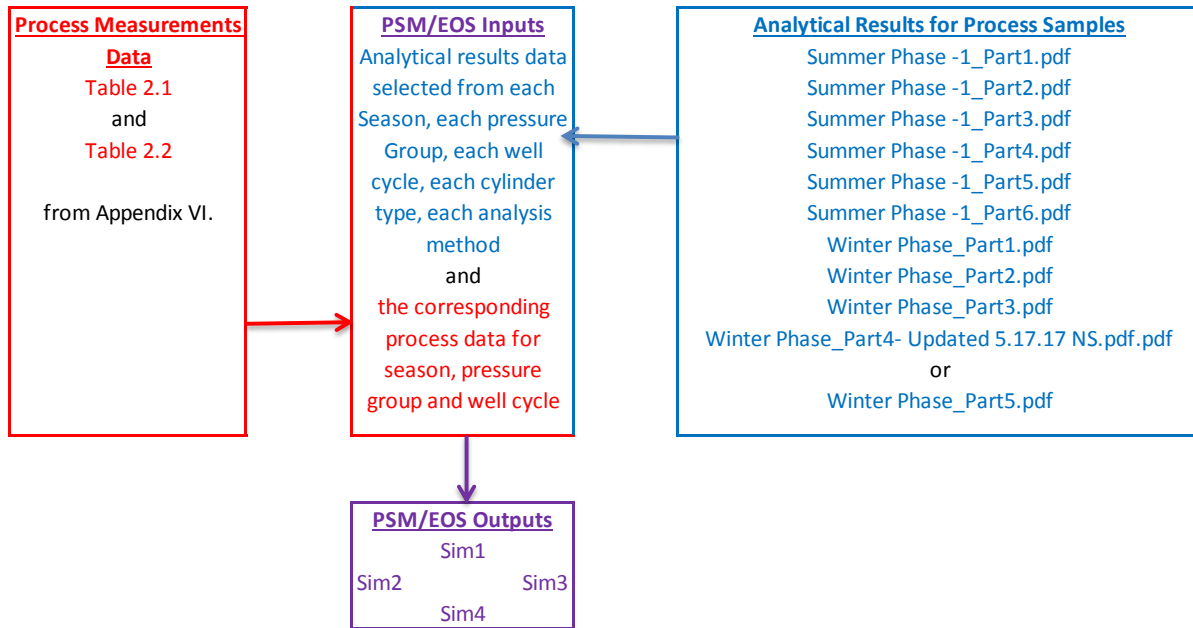

Figure 2-4. Data flow for PSM/EOS calculations.

Table 2-1 lists the average operating conditions during the Winter testing well cycles, and Table 2-2 lists the average operating conditions during the Summer testing well cycles. These values were used for the PSM/EOS calculations of FGOR and sample bubble point pressure at the separator temperature. Table 2-3 lists the engineering units and standard conditions for the PSM/EOS calculations. Table 2-4 lists the pressurized condensate composition used for the PSM/EOS calculations. Review of the analytical results determined that nitrogen in samples above trace levels were a result of air entrainment during sample collection (refer to Section 4.1 of the Final Report). The threshold amount for this study was 0.020 mole %. Nitrogen-free compositions were used when analytical results exceeded this threshold value.

Table 2-1. Average Operating Conditions During Winter 3-Pressure Testing Well Cycles

Parameter	Well Cycle ^A								
	HP1	HP3	HP4	MP1	MP2	MP3	LP1	LP2	LP3
Separator Temperature (°F)	84.6	59.4	58.3	80.7	92.3	85.1	87.4	90.4	85.0
Separator Pressure (psig)	262.3	245.7	263.3	235.0	227.2	228.9	178.3	178.5	180.0
Ambient Pressure (psia)	12.33	12.33	12.33	12.33	12.33	12.33	12.33	12.33	12.33
Separator Pressure (psia)	274.6	258.0	275.6	247.3	239.5	241.2	190.6	190.8	192.3
Siphon Hole Fraction	0.06	0.06	0.06	0.06	0.06	0.06	0.06	0.06	0.06
Tank Headspace Temperature (°F)	65.5	48.9	70.2	56.8	73.7	56.8	85.5	79.3	59.7
Tank Headspace Pressure (oz) ^B	3.5	3.5	3.5	3.5	3.5	3.5	3.5	3.5	3.5
Tank Headspace Pressure (psia)	12.55	12.55	12.55	12.55	12.55	12.55	12.55	12.55	12.55
Tank Bottom Temperature (°F)	46.0	46.5	45.3	45.0	44.0	46.0	45.0	45.8	47.0
Tank Liquids Height (inches)	130.2	130.4	130.8	131.8	132.3	132.8	133.9	134.3	134.5
Tank liquids Density (SG)	0.7587	0.7587	0.7587	0.7587	0.7587	0.7587	0.7587	0.7587	0.7587
Tank Bottom Pressure (psia)	15.79	15.79	15.81	15.83	15.85	15.86	15.89	15.90	15.91
Sales Gas Production (Mscfd)	7.971	7.898	7.714	7.257	6.974	6.896	7.175	6.137	7.507

A. Well cycle process data from Appendix IV.

B. Assumed to be the midpoint of 2 - 5 oz (VOC burner off and on pressures)

Table 2-2. Average Operating Conditions During Summer 3-Pressure Testing Well Cycles

Parameter	Well Cycle ^A										
	S-HP1	S-HP2	S-HP3	S-MP1	S-MP2	S-MP3	S-MP4	S-MP5	S-LP1	S-LP2	S-LP3
Separator Temperature (°F)	62.5	77.9	85.8	65.9	69.7	84.2	62.1	71.7	66.7	69.6	80.3
Separator Pressure (psig)	267.5	264.1	265.0	229.4	227.7	234.0	229.0	230.5	177.7	175.3	177.9
Ambient Pressure (psia)	12.34	12.37	12.36	12.34	12.31	12.33	12.34	12.36	12.33	12.33	12.33
Separator Pressure (psia)	279.8	276.5	277.4	241.7	240.0	246.3	241.3	242.9	190.0	187.6	190.2
Siphon Hole Fraction	0.06	0.06	0.06	0.06	0.06	0.06	0.06	0.06	0.06	0.06	0.06
Tank Headspace Temperature (°F)	70.1	99.6	99.8	75.0	88.9	89.6	71.4	87.0	71.7	88.8	95.8
Tank Headspace Pressure (oz) ^B	3.5	3.5	3.5	3.5	3.5	3.5	3.5	3.5	3.5	3.5	3.5
Tank Headspace Pressure (psia)	12.56	12.59	12.58	12.56	12.53	12.55	12.56	12.58	12.55	12.55	12.55
Tank Bottom Temperature (°F)	76.7	80.0	82.9	78.2	79.3	80.3	75.0	76.2	75.1	75.8	77.9
Tank Liquids Height (inches)	156.6	156.8	157.5	157.8	158.1	158.0	158.5	158.7	160.5	160.8	161.2
Tank liquids Density (SG)	0.7595	0.76	0.7595	0.7595	0.7595	0.7595	0.7595	0.7595	0.7595	0.7595	0.7595
Tank Bottom Pressure (psia)	16.53	16.56	16.57	16.56	16.54	16.55	16.58	16.60	16.62	16.63	16.64
Sales Gas Production Mscfd)	10.896	8.903	7.762	8.204	7.898	7.614	8.821	7.625	8.078	7.211	7.237

A. Well cycle process data from Appendix IV.

B. Assumed to be the midpoint of 2 - 5 oz (VOC burner off and on pressures)

Table 2-3. PSM/EOS Calculations Input and Output Data Engineering Units and Standard Conditions

Measured Value	Units	Standard Conditions
Liquid Flow Rates	Std. bbls / day	60°F, 14.73 psia ^A
Gas Flow Rates	Mscfd	60°F, 14.73 psia ^A
Pressure	psia	
Temperature	°F	

A. Sim 3 used Standard Conditions of 60°F, 14.70 psia. This difference resulted in approximately 0.2% difference in FGOR results.

Table 2-4. Pressurized Condensate Composition Input Data for PSM/EOS Calculations (WC S-MP3)^A

Component	Pressurized	Units
Carbon Dioxide	0.401	Mole %
Nitrogen	0.003	Mole %
Methane	5.768	Mole %
Ethane	6.128	Mole %
Propane	7.709	Mole %
Iso-Butane	2.542	Mole %
n-Butane	7.755	Mole %
Iso-Pentane	4.988	Mole %
n-Pentane	6.972	Mole %
n-Hexane	5.765	Mole %
Heptanes	13.323	Mole %
Octanes	10.577	Mole %
Nonanes	4.780	Mole %
Decanes Plus	11.490	Mole %
Benzene	0.773	Mole %
Toluene	2.760	Mole %
Ethylbenzene	0.189	Mole %
m,p-Xylene (100% meta)	2.205	Mole %
o-Xylene	0.510	Mole %
2,2,4-Trimethylpentane	0.046	Mole %
2,2-Dimethylbutane	0.086	Mole %
2,3-Dimethylbutane	0.299	Mole %
Cyclopentane	0.366	Mole %
2-Methylpentane	2.808	Mole %
3-Methylpentane	1.757	Mole %
Water	0.000	Mole %
Total	100.000	Mole %
C10+ Molecular Weight	217.111	lb/lb-mol
C10+ Relative Density at 60°F	0.8237	
C10+ Density at 60°F	51.37	lb/ft ³

A. Example composition from Summer medium pressure well cycle 3 (S-HP3) GPA 2103M analysis (N₂-free)

2.6 Outputs of PSM/EOS Calculations

Table 2-5 lists the process parameters outputs from PSM/EOS calculations of FGOR and sample bubble point pressure at the separator temperature. Table 2-6 lists the compositions of the outlet process streams from PSM/EOS calculations of FGOR. Appendix B is an example of the PSM Model Output sheet.

Table 2-5. Output Data for PSM/EOS Calculations of FGOR

Parameter	Engineering Units
Standard Gas Volume Flow	Scf/day
Temperature	°F
Pressure	psia
Density	Lb / Ft ³
Molecular Weight	Lb/Lb-mol
Standard Post-Flash Liquid Volume Flow	Std. bbls/day
Standard Pre-Flash Liquid Volume Flow	Std. bbls/day
Shrinkage Factor ^a	(bbl/bbl)
Standard Dead Oil Liquid Volume Flow	Std. bbls/day
FGOR	Scf/bbl
Bubble Point Pressure at Tsep	psia

- a. Shrinkage factor is the ratio of the post-flash oil volume at STP to the pre-flash oil volume at STP

Table 2-6. Output Composition Data for PSM/EOS Calculations of FGOR (WC S-MP3)^A

Component	Flash Gas	Storage Tank Oil	Units
Carbon Dioxide	1.449	0.024	Mole %
Nitrogen	0.011	0.000	Mole %
Methane	21.435	0.121	Mole %
Ethane	21.167	0.721	Mole %
Propane	21.861	2.660	Mole %
Iso-Butane	5.242	1.594	Mole %
n-Butane	13.365	5.814	Mole %
Iso-Pentane	4.659	5.145	Mole %
n-Pentane	5.355	7.598	Mole %
n-Hexane	1.489	7.301	Mole %
Heptanes	1.181	17.642	Mole %
Octanes	0.314	14.215	Mole %
Nonanes	0.047	6.456	Mole %
Decanes Plus	0.000	15.556	Mole %
Benzene	0.193	0.981	Mole %
Toluene	0.204	3.668	Mole %
Ethylbenzene	0.005	0.254	Mole %
m-Xylene	0.048	2.970	Mole %
o-Xylene	0.010	0.687	Mole %
2,2,4-Trimethylpentane	0.004	0.061	Mole %
2,2-Dimethylbutane	0.044	0.101	Mole %
2,3-Dimethylbutane	0.118	0.365	Mole %
Cyclopentane	0.206	0.425	Mole %
2-Methylpentane	1.020	3.455	Mole %
3-Methylpentane	0.574	2.184	Mole %
Water	0.000	0.000	Mole %

A. Example composition from Summer Medium pressure well cycle 3 (S-MP3) GPA 2103M analysis

3. Results: PSM/EOS Separator Mass Balance, FGOR, and Bubble Point Pressure Calculations

3.1 Separator Mass Balance Calculations

Table 3-1 presents example separator balance results. Note that the results indicate some of the oil and water are absorbed in the gas, and analysis of the oil and gas samples for water was not conducted (i.e., analysis of gas and oil for water content by GC is not routine or practical). Some of this effect would likely be reduced if the trace levels of water present in the gas and oil had been quantified.

The oil and gas volumes listed under “Measured” were measured during the individual well cycles associated with pressurized condensate sample collection. The volume of produced

water was very small and the volume of water produced with each well cycle was often less than the separator water box volume (i.e., there were zero water dumps for some well cycles). Therefore, the volume of water for each well cycle was estimated from the volume of oil production and a water/oil ratio determined from numerous well cycles.

Generally, gas predictions were about + 1% of measured, oil predictions were about - 6% of measured, and water predictions were about - 10% of estimated. As indicated in Table 3-1, Sim1, Sim2 and Sim3 results had excellent agreement. The GOR results calculated from these data are likely overstated, possibly due to volume translation error in the EOS. This was not corrected in the study, although it was discussed. It is likely that FGOR results will have a similar positive bias. Refer to Appendix V.3.

Table 3-1. Example Separator Mass Balance Results

Separator Feed			Outflows			
	Measured		Sim 1	Sim 2	Sim 3	
Gas (Mscfd)	7.614		7.688	7.692	7.685	Mscfd
Sim x / Measured			101.0%	101.0%	100.9%	%
Oil (Bbl.)	0.522		0.479	0.477	0.485	bbl/d
Sim x / Measured			91.8%	91.4%	92.9%	%
Water (Bbl.)	0.026		0.024	0.024	0.023	bbl/d
Sim x / Measured			90.1%	90.0%	89.1%	%

- a. Predicted volumes for Summer, Medium Pressure Group 3, Sim 1, Sim 2, and Sim 3 model results shown in this example

3.1. FGOR Models Calculations

The PSM assumes the pressurized condensate is in equilibrium at the separator pressure and temperature, and no gas flashes in the separator. FGOR values were calculated by zeroing the gas and water volumes going to “Mixer 1” in Figure 2.3. If this step is not done, the FGOR value will be affected by the differences between measured and modeled shown in the Separator Balance discussed in Section 3.1. This leaves only the pressurized condensate going into and out from the separator to the storage tank. This value is compared to the Direct Measurement FGOR. Table 3.2 shows an example of the comparison of FGOR from the four simulation packages.

Table 3-2. Comparison of EOS Calculated FGOR to Direct Measurement FGOR

Property	Sim 1	Sim 2	Sim 3	Sim 4	Units
Separator Temperature	84.2	84.2	84.2	84.2	°F
Separator Pressure	246.33	246.33	246.33	246.33	psia
Bubble Point P at T _{Sep}	228.3	247.1	236.8	N/A	psia
Flash Gas to Oil Ratio (FGOR)	311.7	311.5	310.5	257.5	scf/bbl.
Direct Measurement FGOR (refer to Section 4.7 of the final report)	308.9	308.9	308.9	308.9	scf/bbl.
Shrinkage ^a	0.8309	0.8310	0.8469	N/A	

- Shrinkage factor is the ratio of post-flash oil volume to pre-flash oil volume and does not have units (bbl/bbl)
- Modeling results for Summer, Medium Pressure Group 3 for Sim 1, Sim 2, Sim 3 and Sim 4 results shown in this example

3.3. Dead Oil Model Calculations

As previously discussed in Section 2.3, the PSM/EOS model separator fluid enters an empty tank and the resulting FGOR was often significantly higher than what was measured. An analysis of the storage tank oil was used for the composition of the dead oil. The volume of dead oil was varied until the FGOR calculation matched the measured FGOR for the well cycle. These were the additional inputs used for the Deal Oil Model used to approximate direct measurement results in an effort to understand the quenching effect of the dead oil in the storage tank during the testing. An example of the results for Sim1, Sim2, and Sim3 are shown in Table 3.3.

Table 3-3. Example Mass Balance Results Showing Dead Oil Volume Required to Match Direct Measurement

Typical Mass Balance Results					
	Direct Measurement	Sim 1	Sim 2	Sim 3	Units
Flash Gas to Oil Ratio (FGOR) – Standard	309	309	309	309	scf/bbl
Dead Oil Volume required to match Direct Measurement FGOR ^a		0.11	0.10	0.10	bbl/d

- Differences in dead oil volume required mixing with live oil to match direct measurement mass balance FGOR is likely due to subtle differences in the three models.
- PSM/EOS results for Summer, Medium Pressure Group 3, for Sim 1, Sim 2, and Sim3 model results shown in this example

3.4 Bubble Point Pressure Calculations

Figure 2-6 shows a Phase Envelope for one of the samples for this project. The phase envelope is a graphic representation of the EOS thermodynamic model output. The Y-axis is pressure in psia and the X-axis is temperature in °F. The red line shows the Bubble Point curve and the blue line shows the Dew Point curve. To the left of and above the red line is the Liquid Region, and a mixture in this area is 100% liquid. To the right of and below the red line is the 2-Phase Region, and a mixture in this region is less than 100% liquid. If sample conditions are not within an acceptable tolerance of this red line, then it is likely that the sampling and analysis results are not representative of a fluid at those conditions. The green star shows the sample conditions and proximity to the red line. In this case, the sample conditions are almost centered on the line, indicating that the results are likely representative of a fluid at those conditions. For this study, which had highly controlled operating conditions and accurate temperature and pressure measurement, the results were typically within $\pm 7\%$. Normally accepted tolerances are around 20-30%.

Also shown is the Vapor Region to the right of and below the blue Dew Point curve. For gas compositions, the same general process applies. Sample conditions should be within an acceptable tolerance of this line. The red dot in Figure 2-6 is the Cricondenbar Point, and represents the highest pressure that a 2-phase mixture can exist. The blue dot is the Cricondentherm Point and represents the highest temperature that a 2-phase mixture can exist. The yellow dot is the Critical Point and mixtures above this temperature and pressure are supercritical fluids.

Separator fluids are assumed to be at equilibrium in the separator. Therefore, when the sample collection process is executed it is imperative to keep pressure and temperature changes minimal. Changes in pressure or temperature can cause phase change. If the pressure drops or the temperature increases, then the sampling conditions enter the 2-Phase region. The sample drops below its Bubble Point, gas bubbles form in the liquid, and the subsequent analysis of this fluid have excess lighter (higher vapor pressure components) and the resulting plot would show the green star in the 2-Phase Region.

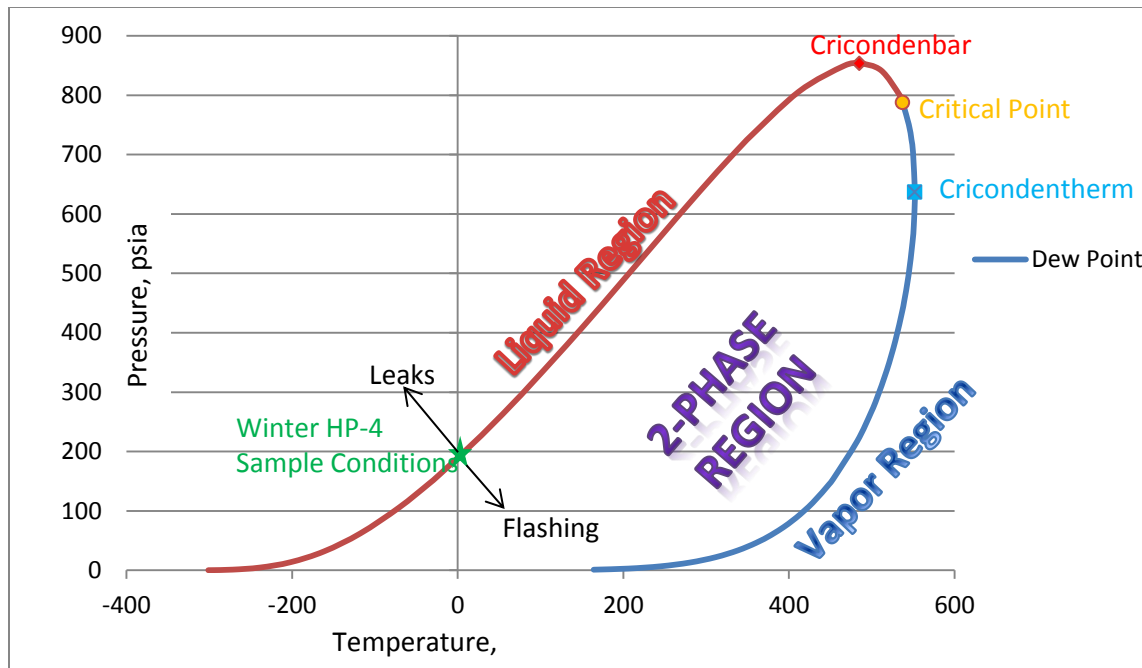

Figure 3-1. Phase envelope for a condensate sample tested for the PHLSA study.

Reciprocally, if the sample cylinder leaks, lighter hydrocarbons gasify more rapidly than heavier hydrocarbons and therefore have more losses than the heavier. The subsequent analysis of this fluid will cause the red line to be lower, and the green star further into the Liquid Region. This is why it is important that the sample is collected, handled and analyzed in a manner to prevent phase change from occurring.

4. PSM/EOS FGOR Calculations Sensitivity Study

4.1 Sensitivity Study

4.1.1 Numerical Approximation Approach

Sensitivity studies were performed to determine the sensitivity of key parameters calculated by varying one PSM/EOS input parameter at a time, keeping all others constant, to evaluate impact of each parameter on the PSM/EOS output. Measurement data was input over normal observed variations, utilizing the uncertainty of each measurement. The sensitivity data was used to create an uncertainty budget for the normal variations and uncertainty of input data. In the case of Storage Tank Pressure, the Pressure at one foot from the bottom of the tank was calculated and sensitivity perturbation values were calculated as shown below in Table 4.1. A similar approach was used for other sensitivity perturbation values. Six well cycles, one from each study phase, were selected which showed the best results in the direct measurement mass balance. Only CP cylinder analyses were used, samples collected at 20 ml per minute,

collected less than 30 minutes after the completion of the well cycle, for both GPA 2103M and GPA 2186M analysis methods.

Table 4.1. Sensitivity Study for Storage Tank Conditions and Decanes Plus Properties – Numerical Approximation Approach

EOS Sensitivity Study - Summer Phase - Medium Pressure #3 - GPA 2103M					
Tank Headspace temperature	Value	Units	FGOR	Shrinkage	B. Pt.
1 Minimum - Uncertainty (°F)	86.6	°F	313	0.8300	228.3
2 (Average + Minimum - Uncertainty)/2	88.1	°F	314	0.8298	228.3
3 Average (°F)	89.6	°F	314	0.8296	228.3
4 (Average + Maximum + Uncertainty)/2	91.2	°F	315	0.8293	228.3
5 Maximum + Uncertainty (°F)	92.7	°F	315	0.8291	228.3
Tank Headspace pressure	Value	Units	FGOR	Shrinkage	B. Pt.
6 Minimum -Uncertainty (PIT 2/16 + Pambient) (psi)	12.38	psia	314	0.8294	228.3
7 (Average + Minimum - Uncertainty)/2	12.47	psia	314	0.8295	228.3
8 Average (PIT 2/16 + Pambient) (psi)	12.55	psia	314	0.8295	228.3
9 (Average + Maximum + Uncertainty)/2	12.63	psia	314	0.8296	228.3
10 Maximum + Uncertainty (PIT 2/16 + Pambient) (psi)	12.72	psia	314	0.8296	228.3
Tank 1' from Bottom temperature	Value	Units	FGOR	Shrinkage	B. Pt.
11 Average -Uncertainty (°F)	78.8	°F	310	0.8321	228.3
12 Average -1/2 Uncertainty (°F)	79.5	°F	312	0.8309	228.3
13 Average	80.3	°F	314	0.8296	228.3
14 Average + 1/2 Uncertainty (°F)	81.0	°F	316	0.8284	228.3
15 Average + Uncertainty (°F)	81.8	°F	319	0.8270	228.3
Tank 1' from Bottom pressure	Value	Units	FGOR	Shrinkage	B. Pt.
16 Minimum -Uncertainty (psi)	16.39	psia	313	0.8300	228.3
17 (Average + Minimum - Uncertainty)/2	16.47	psia	313	0.8304	228.3
18 Average (Pamb + PIT2 + L*ρ*Constant) (psi)	16.55	psia	312	0.8309	228.3
19 (Average + Maximum + Uncertainty)/2	16.64	psia	311	0.8314	228.3
20 Maximum + Uncertainty (PIT 2/16 + Pambient) (psi)	16.72	psia	310	0.8318	228.3
Decanes Plus Molecular Weight	Value	Units	FGOR	Shrinkage	B. Pt.
21 Minimum - U	208.231	gm/gm-mol	318	0.8280	229.0
22 (Average + Minimum - U)/2	210.732	gm/gm-mol	317	0.8285	228.8
23 Average	213.233	gm/gm-mol	316	0.8289	228.6
24 (Average + Maximum + U)/2	216.004	gm/gm-mol	315	0.8294	228.4
25 Maximum + U	218.774	gm/gm-mol	314	0.8298	228.2
Decanes Plus Density	Value	Units	FGOR	Shrinkage	B. Pt.
26 Minimum - U	0.8169	(H ₂ O=1)	313	0.8300	227.3
27 (Average + Minimum - U)/2	0.8195	(H ₂ O=1)	314	0.8298	227.7
28 Average	0.8221	(H ₂ O=1)	314	0.8297	228.1
29 (Average + Maximum + U)/2	0.8249	(H ₂ O=1)	314	0.8295	228.5
30 Maximum + U	0.8278	(H ₂ O=1)	315	0.8293	229.0

Sensitivity study results for Summer, Medium Pressure Group 3, for Sim 1 model results shown in this example. The complete set of results can be found in Appendix V.4.

A similar approach was used for the effects of separator conditions. Table 4.2 below shows the results for Summer, Medium Pressure Group 3, for Sim 1 model results. The complete set of results can be found in Appendix V.4.

Table 4-2. Sensitivity Study for Separator Conditions and SPH Fraction – Numerical Approximation Approach

EOS Sensitivity Study - Summer Phase - Medium Pressure #3 - GPA 2103M					
Psep (psia)	Value	Units	FGOR	Shrinkage B. Pt.	
31	236.3	psia	311	0.8310	228.3
32	231.3	psia	307	0.8317	228.3
33	226.3	psia	303	0.8325	228.3
34	221.3	psia	299	0.8332	228.3
35	216.3	psia	295	0.8339	228.3
Tsep (°F)	Value	Units	FGOR	Shrinkage B. Pt.	
36	92.2	°F	311	0.8310	228.3
37	94.2	°F	309	0.8313	228.3
38	96.2	°F	308	0.8316	228.3
39	98.2	°F	306	0.8319	228.3
40	100.2	°F	304	0.8322	228.3
Siphon Prevention Hole	Value	Units	FGOR	Shrinkage B. Pt.	
41	0.00	(0-1)	306	0.8338	237.6
42	0.03	(0-1)	309	0.8323	237.6
43	0.06	(0-1)	312	0.8308	237.6
44	0.12	(0-1)	317	0.8279	237.6
45	0.24	(0-1)	328	0.8219	237.6
46	0.48	(0-1)	351	0.8101	237.6
47	1.00	(0-1)	402	0.7844	237.6

Table 4.3 shows the average results obtained in the sensitivity study. One set of sample data was selected from each set of pressure groups (3) for each seasonal test (2) for each analytical method (2) for a total of 12 data sets. Six perturbations were performed on each data set. The particular data sets used were the ones that had the best mass balance results for that pressure group. The complete set of results can be found in Appendix V.4.

Individual results were similar, but showed slightly less sensitivity to temperature and pressure for GPA 2186M and slightly less sensitivity to Decanes Plus properties for GPA 2103M. Note that the “siphon prevention hole” flow was 6% to the tank headspace, with 94% of the flow going to one foot from the tank bottom. This is why the tank headspace conditions show less sensitivity than the tank bottom conditions. The effects will be different as the ratio for the “siphon prevention hole” changes, as with side-spray and 100% flow to the tank headspace.

Bubble Point is insensitive to the “tank” conditions since this value is calculated at the separator conditions.

Table 4.3. Average Results of Sensitivity Study

Perturbation	Parameter	Study Average	Units
Tank Headspace Temperature	FGOR	0.08%	per°F
	Shrinkage	-0.01%	per°F
Tank Headspace Pressure	FGOR	-0.37%	per psi
	Shrinkage	0.06%	per psi
Tank Bottom Temperature	FGOR	0.97%	per°F
	Shrinkage	-0.16%	per°F
Tank Bottom Pressure	FGOR	-0.22%	per ounce
	Shrinkage	0.54%	per psi
Separator Temperature	FGOR	0.33%	per°F
	Shrinkage	-0.01%	per°F
Separator Pressure	FGOR	-0.30%	per psi
	Shrinkage	0.01%	per psi
Decanes Plus Mole Weight	FGOR	-0.20%	per gm/gm-mol
	Shrinkage	0.03%	per gm/gm-mol
	B. Point	-0.04%	per gm/gm-mol
Decanes Plus Density	FGOR	0.03%	per .0010
	Shrinkage	-0.01%	per .0010
	B. Point	0.07%	per .0010
Siphon Prevention Hole Fraction	FGOR	0.50%	per .01
	Shrinkage	-0.07%	per .01

4.1.2 Monte Carlo Simulation

Similar data tables were used in a Monte Carlo Simulation for each of the 6 well cycles and 2 analytical methods used in the Numerical Approximation approach. Additionally, analytical data was varied within the uncertainty of each compositional value. See Table 4.4-A and 4.4-B.

Approximately 3,000 iterations produced a normal distribution of data and a similar uncertainty budget. The results are discussed in Section 5 of this appendix. Sim 3 was used for the Monte Carlo simulations due to the PSM/EOS design for Excel input/output and the ease of linking it to the Crystal Ball software. The complete set of results can be found in Appendix V.5.

Table 4-4A. Monte Carlo Simulation Input Data – Process Data

			STD	Min Value	Max Value	Distribution Type
Oil Flow Rate	0.5219	bbbl/d	0.00151			Normal
Separator Temperature	84.2	°F	1.15	82.21	86.19	Rectangular
Separator Pressure	246.33	psia	2.90	241.31	251.35	Rectangular
Siphon hole fraction	0.06	(0 - 1)	0.012	0.04	0.08	Rectangular
Tank HS Temperature	89.6	°F	1.17	87.58	91.62	Rectangular
Tank HS Pressure	12.55	psia	0.069	12.43	12.67	Rectangular
Tank Bottom Temperature	80.3	°F	0.87	78.79	81.81	Rectangular
Tank Bottom Pressure	16.54	psia	0.071			Normal

Table 4-4B. Monte Carlo Simulation Input Data – Analytical Data

Components	Avg	STD	Units	Distribution Type	
Carbon Dioxide	0.401	0.003	mol%	Normal	
Nitrogen	0.000	0.000	mol%	Normal	
Methane	5.770	0.063	mol%	Normal	
Ethane	6.130	0.048	mol%	Normal	
Propane	7.710	0.051	mol%	Normal	
Iso-Butane	2.540	0.012	mol%	Normal	
n-Butane	7.760	0.040	mol%	Normal	
Iso-Pentane	4.990	0.059	mol%	Normal	
n-Pentane	6.970	0.029	mol%	Normal	
n-Hexane	5.770	0.125	mol%	Normal	
Heptanes	13.303	0.202	mol%	Normal	
Octanes	10.577	0.346	mol%	Normal	
Nonanes	4.780	0.061	mol%	Normal	
Decanes Plus	11.490	0.148	mol%	Normal	
Benzene	0.773	0.021	mol%	Normal	
Toluene	2.760	0.031	mol%	Normal	
Ethylbenzene	0.189	0.018	mol%	Normal	
m, p-Xylenes	2.210	0.029	mol%	Normal	
o-Xylene	0.510	0.007	mol%	Normal	
2,2,4-Trimethylpentane	0.046	0.000	mol%	Normal	
2,2-Dimethylbutane	0.086	0.000	mol%	Normal	
2,3-Dimethylbutane	0.299	0.001	mol%	Normal	
Cyclopentane	0.366	0.001	mol%	Normal	
2-Methylpentane	2.810	0.007	mol%	Normal	
3-Methylpentane	1.760	0.004	mol%	Normal	
	100				
C10+ Properties					
Mol Wt.	217.11	1.95	lb/lb-mol	Normal	-8.9
Sp. Gravity at 60°F	0.8237	0.0082	adim.	Normal	-0.0049

4.2 Equation of State Models

The Peng-Robinson equation of state was used in the

PSM/EOS modeling portion of the study. 22 EOS models with various activity coefficient methods were evaluated and six were selected as fit for purpose to evaluate the effect of EOS selection on calculated results. Three of the tested EOS models more suited for natural gas modeling failed to resolve. Six EOS were selected and tested in the comparison after evaluating

the performance on two data sets, one from GPA 2186M and one from GPA 2103M results. Table 4.5 shows the results of one data set from the EOS Model Perturbation.

Table 4-5. EOS Model Selection Results

		Advanced Peng-Robinson	E-Soave-Redlich-Kwong	Bendict-Webb-Rubin-Starling	Refinery Soave-Redlich-Kwong-LK	Gibbs Excess Peng-Robinson	Chao Seader Peng-Robinson	Bendict-Webb-Rubin	units
Summer MP-3 (GPA 2103M)	FGOR	314	302	341	305	303	306	390	scf/std. bbl.
	MB100	309	309	309	309	309	309	309	scf/std. bbl.
	FGOR/MB100	102%	98%	110%	99%	98%	99%	126%	%
	B. Pt.	228.3	248.8	218.0	209.9	196.8	180.6	250.2	psia
	Psep	240.3	240.3	240.3	240.3	240.3	240.3	240.3	psia
	B.Pt./P _{sep}	95%	104%	91%	87%	82%	75%	104%	%

- Advanced PR was the EOS model used in this study.
- MB 100 is the Direct Measurement results corrected to 100% Mass Balance.
- PSM/EOS results for Summer, Medium Pressure Group 3, for Sim 1, Sim 2, and Sim3 model results shown in this example. The complete set of results can be found in Appendix V.4.

5. FGOR Uncertainty Study

Using the sensitivity results of the Monte Carlo Simulation, a relative expanded uncertainty for FGOR calculated using PSM/EOS modeling of pressurized condensate analyses is approximately 3.3% of value at 95% confidence. A slightly higher result was obtained using the results of the Numerical Approximation approach. See Table 5.1 for FGOR uncertainty from both approaches. Table 5.2 lists the uncertainty of Bubble Point Calculations and Table 5.3 lists the uncertainty of Shrinkage Calculations using these two approaches. There is reasonable agreement of these two approaches.

Table 5-1. FGOR Uncertainty Calculations

Season	Well Cycle	2103		2186	
		Numerical Approximation	Monte Carlo Simulation	Numerical Approximation	Monte Carlo Simulation
SUMMER	LP	3.80%	3.00%	4.00%	3.30%
SUMMER	MP	2.80%	2.80%	3.10%	3.00%
SUMMER	HP	2.80%	2.70%	3.70%	2.90%
WINTER	LP	4.90%	3.80%	4.70%	3.80%
WINTER	MP	3.80%	3.30%	3.70%	3.30%
WINTER	HP	3.30%	3.10%	3.00%	3.10%

Table 5-2. Bubble Point Uncertainty Calculations

Season	Well Cycle	2103		2186	
		Numerical Approximation	Monte Carlo Simulation	Numerical Approximation	Monte Carlo Simulation
SUMMER	LP	1.10%	2.20%	1.00%	2.90%
SUMMER	MP	1.10%	2.20%	1.00%	2.90%
SUMMER	HP	1.10%	2.20%	1.20%	2.90%
WINTER	LP	1.20%	3.00%	0.80%	3.00%
WINTER	MP	1.20%	3.00%	0.80%	3.00%
WINTER	HP	0.90%	3.10%	0.70%	3.10%

Table 5-3. Shrinkage Factor Uncertainty Calculations

Season	Well Cycle	2103		2186	
		Numerical Approximation	Monte Carlo Simulation	Numerical Approximation	Monte Carlo Simulation
SUMMER	LP	0.50%	0.44%	0.47%	0.44%
SUMMER	MP	0.57%	0.50%	0.46%	0.49%
SUMMER	HP	0.57%	0.57%	0.70%	0.54%
WINTER	LP	0.41%	0.32%	0.36%	0.32%
WINTER	MP	0.42%	0.38%	0.37%	0.38%
WINTER	HP	0.56%	0.55%	0.49%	0.55%

6. Conclusions and Recommendations

Suggested considerations for PSM/EOS calculations of bubble point pressures and FGOR:

- Accurately measured the separator tank liquid temperature.
- Accurately measured the separator tank pressure (suggest redundant pressure gauges).
- Accurately measure the tank bottom temperature for tanks with down-comers and the tank headspace temperature for tanks that use side fill
- To model FGOR to be used to design storage tank emission control systems collect a pressurized condensate sample during high pressure / low temperature separator operation and assume maximum tank temperatures and minimum tank pressures for PSM/EOS calculations.
- To model FGOR to be used to be used for emission inventory estimates, collect a pressurized condensate sample during medium pressure / medium temperature separator operation and assume medium tank temperatures and medium tank pressures for PSM/EOS calculations.
- Analyze the pressurized condensate through decanes plus at a minimum, and accurately determine or calculate the plus fraction density and molecular weight

Appendix V.1. Estimated Discharge From Siphon Prevention Hole

A discovery during the testing was that the storage tank down-comer pipe has a 3/8" hole near the top of the tank. This "siphon prevention hole" was installed as a safety feature. Absent such a hole, in the event of an upset condition where a negative pressure is applied on the separator, a siphon could form and oil would flow from the tank back to the separator. The siphon prevention hole was drilled to prevent siphon formation and such back-flow. An illustration of the hole location within the tank is shown in Figure V1-1.

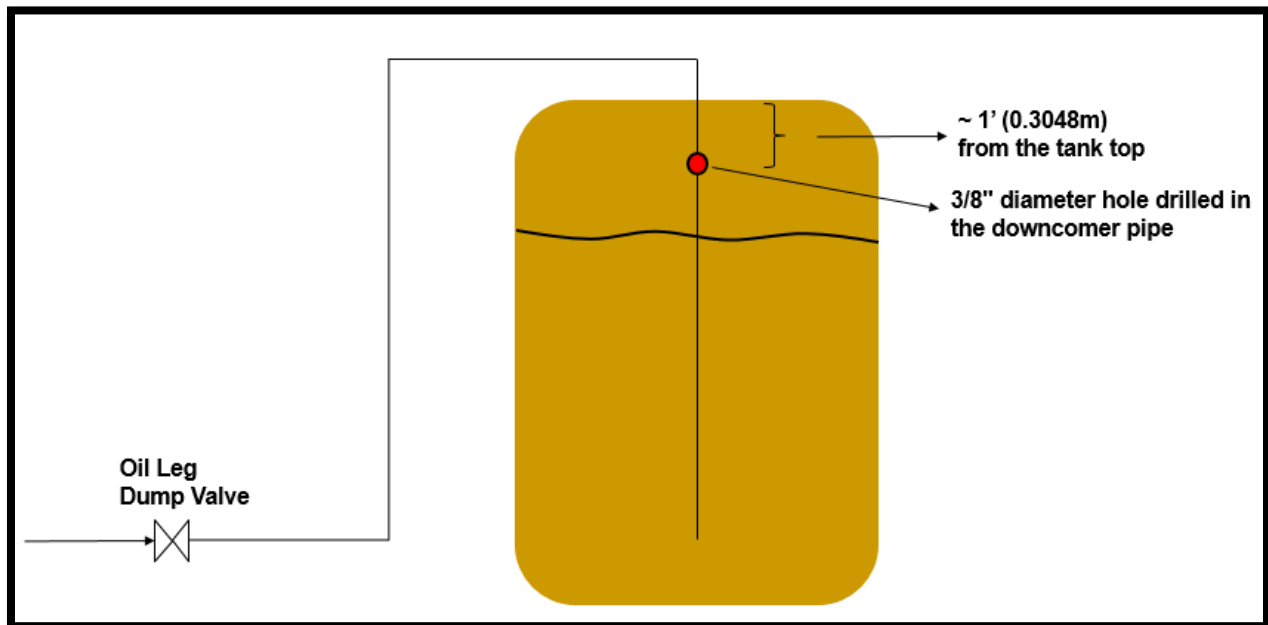

Figure V1.1. Location of the siphon prevention hole on the down-comer pipe.

It is expected that some of the fluids flowing from the separator to the tank pass through the siphon prevention hole into the tank headspace. The tank headspace temperature and pressure differ from the tank bottom conditions where the majority of the separator fluids are expected to flow, and this temperature and pressure difference would impact liquids flashing. The tank headspace gas temperature was usually higher than the tank bottom liquids temperature and the tank headspace gas pressure was lower than the tank bottom pressure, and both of these trends favor higher FGOR for liquids that pass through the siphon prevention hole. The flow from the separator to the tank is two-phase, gas and liquid, and the gas to liquid ratio likely changes over the course of each separator dump. Measuring the rate and composition of the siphon prevention hole flow was beyond the scope of this study, and a simple model assuming incompressible flow was used to estimate the relative flows through the siphon prevention hole and to the tank bottom.

Flow through the siphon prevention hole was estimated using the following equation for incompressible flow through an orifice.

$$Q_{SPH} = C * A_{SPH} * \text{SQRT}\left(\frac{2 * \Delta P_{SPH}}{\rho}\right)$$

Where:

Q_{SPH} = Siphon Prevention Hole (SPH) discharge flow rate (m³/s)

C = Discharge coefficient, assumed to be 0.6 (unitless)

A_{SPH} = SPH cross sectional area (m²)

D_{SPH} = SPH diameter = 0.375 inches = 0.00953 meter

ρ = Density of the separator to tank flow fluid (kg/m³)

ΔP_{SPH} = Pressure change across the SPH = 10 psi

- 10 psig was a typical pressure measured in the vicinity of the SPH during well cycles. Typical range was 8 to 12 psig as shown in Figure V1-2.

Flow through the down-comer pipe was estimated using the Darcy-Weisbach equation for incompressible flow through pipe.

$$Q_{DC} = A_{DC} * \text{SQRT}\left(\frac{2 * D_{DC} * \Delta P_{DC}}{f * L_{DC} * \rho}\right)$$

Q_{DC} = Down-comer (DC) flow rate (m³/s)

A_{DC} = DC pipe cross sectional area (m²)

D_{DC} = DC pipe diameter = 1.6875 inches = 0.0429 meter

L_{DC} = DC pipe length from SPH to discharge = 13 feet = 3.96 meter

f – friction factor

ρ = Density of the separator to tank flow fluid (kg/m³)

ΔP_{DC} = Pressure change down the DC pipe = 10 – 4 = 6 psi

- 10 psig was typical pressure measured in the vicinity of the SPH during well cycles and 4 psi is estimated liquid head pressure at the down-comer discharge (12 feet * SG = 0.76 * 0.4331 psi/ft H₂O)

The ratio of Q_{SPH} and Q_{DC} is estimated to be:

$$\frac{Q_{SPH}}{Q_{DC}} = \frac{C * A_{SPH} * \text{SQRT}\left(\frac{2 * \Delta P_{SPH}}{\rho}\right)}{A_{DC} * \text{SQRT}\left(\frac{2 * D_{DC} * \Delta P_{DC}}{f * L_{DC} * \rho}\right)} = \frac{C * D_{SPH} * D_{SPH} * \text{SQRT}\left(\frac{\Delta P_{SPH}}{\Delta P_{DC}} * \frac{f * L_{DC}}{D_{DC}}\right)}{D_{DC} * D_{DC}}$$

Entering the values listed above into the equation calculates an estimated Q_{SPH} / Q_{DC} ratio of about 0.06 or 6%. A pseudo-Monte Carlo simulation, conducted by systematically varying the primary input parameters over their estimated uncertainty ranges, estimated a Q_{SPH} / Q_{DC} ratio uncertainty of 6% +/- 2%.

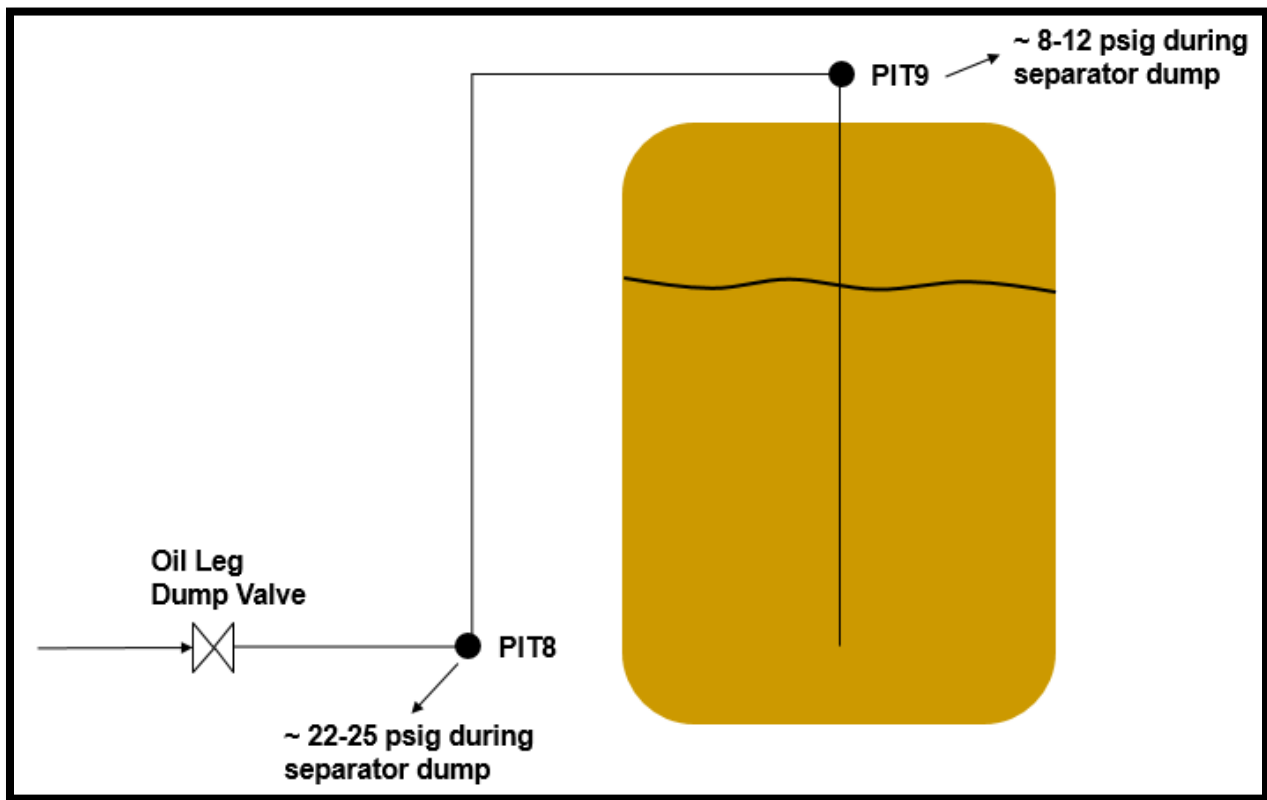

Figure V1-2. Location of pressure transducers used to estimate the flow through the hole.

Appendix V.2 – PSM Instructions**Sim1 Instructions****Separator Balance**

- 1 Input header data: Study Phase, Study Group, CoA#, Method, Sample Date, Cylinder No. & type, Sample Pressure and Temperature, Sample Rate, Sample Location, and Test Description
- 2 Input Feed Gas composition (from Sales Gas analysis for this well-cycle) in mol %, temperature, pressure, and flow rate
- 3 Input Feed Oil composition (from Pressurized Condensate analysis for this well-cycle) in mol %, temperature, pressure, and flow rate
- 4 Input Feed Oil C10+ MW and SG (in Property Package from Pressurized Condensate analysis for this well-cycle)
- 5 Input Feed Water composition (from Pressurized Water analysis for this season) in mol%, temperature, pressure and flow rate
- 6 Input Dead Oil composition (air-free basis from Storage Tank Condensate Analysis for this season) mol% and flow rate
- 7 Input Dead Oil C10+ MW and SG (in Property Package from Storage Tank Condensate analysis for this season)
- 8 Input separator temperature and pressure in "Vap/Sales_Gas.In"
- 9 Allow model to resolve and save as "model ID+Separator Balance"

FGOR

- 10 Input % flow to siphon hole in Specification Panel "/Siphon.FlowFraction1.Fraction"
- 11 Input tank headspace temperature ("/Siphon_1.Vap.T") and pressure ("/V1.Out.P") in Specification Panel
- 12 Input tank bottom temperature ("/Tank_Bottom.Vap.T") and pressure ("/Oil_to_Tank.In.P") in Specification Panel
- 13 Input Feed Gas flow rate as 0
- 14 Input Feed Water flow rate as 0
- 15 Input the separator pressure 1 psi above the calculated Bubble Point at Tsep
- 16 Allow model to resolve and save as "model ID+FGOR"

Mass Balance

- 17 Change the dead oil flow rate to obtain measured FGOR = Modeled FGOR
- 18 Allow model to resolve and save as "model ID+Mass Balance"
- 19 Change the dead oil volume rate to zero

Sim2 / Sim3 Instructions**Separator Balance**

- 1 Input modeling ID number, sample type, sample name, and sample date
- 2 Input sales gas composition, temperature, pressure and flow rate
- 3 Input pressurized oil composition (mol%), temperature, pressure and flow rate
- 4 Input pressurized oil C10+ MW and SG
- 5 Input pressurized water composition (mol%), temperature, pressure and flow rate
- 6 Input dead oil composition (air-free basis, mol%)
- 7 Input dead Oil C10+ MW and SG
- 8 Input separator temperature and pressure (Table No.1)
- 9 Solve for the pressurized oil bubble point at sample temperature (Table No.2)
- 10 Solve for the pressurized oil bubble point at separator temperature (Table No.2)

FGOR

- 11 Input discharge through siphon hole (Table No.3)
- 12 Input tank headspace temperature (Table No.3)
- 13 Input tank headspace pressure (Table No.3)
- 14 Input tank bottom temperature (Table No.3)
- 15 Input tank bottom pressure (Table No.3)
- 16 Make sure the dead oil pressure and temperature are equal to that of the tank bottom
- 17 Input sales gas composition flow rate as 0
- 18 Input pressurized water composition flow rate as 0
- 19 Copy the sales gas composition and flow rate to the "OUTPUT Separator" tab
- 20 Copy the pressurized oil composition and flow rate to the "OUTPUT Separator" tab
- 21 Copy the pressurized water composition and flow rate to the "OUTPUT Separator" tab
- 22 In the simulation file, set the pressurized gas stream to zero flow rate
- 23 In the simulation file, set the pressurized water stream to zero flow rate
- 24 Increase the separator pressure to above its bubble point
- 25 Fill in Table No. 3 using the separator pressure used in step (25)

Mass Balance

- 26 Change the dead oil volume rate to obtain measured FGOR = Modeled FGOR
- 27 Fill in Table No. 4
- 28 Fill the upper table in the "OUTPUT Tank" tab
- 29 Change the dead oil volume rate to zero
- 30 Fill in Table No. 5
- 31 Fill the lower table in the "OUTPUT Tank" tab
- 32 If desired, fill Tables 6-8 by using different dead oil volume rates

Sim4 Instructions**FGOR**

1. Input flowsheet Selection (Tank with Separator or Stable Oil Tank) in Configuration sheet
2. Input Model Selection for W&S Losses (AP-42 or RVP Distillation Column) in Configuration sheet
3. Input Known Separator Stream Information (LP Oil, HP Oil, LP gas. Or Geographical Database) in Configuration sheet
4. Input Control Efficiency (use Control Efficiency and Destruction Efficiency)) in Configuration sheet
5. Component Group (Select the last Cn+ in Stream) in Configuration sheet
6. Input Oil composition (in mol % from Pressurized Condensate analysis for this well-cycle) in HP Separator sheet
7. Input Oil C10+ MW and SG (from Pressurized Condensate analysis for this well-cycle) in HP Separator sheet
8. Input separator pressure and temperature in HP Separator sheet
9. Input tank pressure and temperature in Flash Valve sheet
10. Input Days, API Gravity, Reid Vapor Pressure and Flow rate in Sales Oil sheet
11. Save model as Model ID#

Appendix V.3 PSM/EOS Modeling Results

The table below links the PSM/EOC calculations presented in this appendix to the Certificate of Analysis number for the condensate sample.

Certificate of Analysis	Well Cycle ID	Sim 1 and Sim 4		Sim 2 and Sim 3	
		GPA 2103 Model ID	GPA 2186 Model ID	GPA 2103 Model ID	GPA 2186 Model ID
16080474-001A	SHP-1	SHP-1 -1	SHP-1 -4	SHP-1 -1	SHP-1 -1
16080474-002A	SHP-1	SHP-1 -2	SHP-1 -5	SHP-1 -2	SHP-1 -2
16080474-003A	SHP-1	SHP-1 -3	SHP-1 -6	SHP-1 -3	SHP-1 -3
16080474-009A	SHP-2	SHP-2-1	SHP-2-4	SHP-2-1	SHP-2-1
16080474-010A	SHP-2	SHP-2-2	SHP-2-5	SHP-2-2	SHP-2-2
16080474-011A	SHP-2	SHP-2-3	SHP-2-6	SHP-2-3	SHP-2-3
16080474-017A	SHP-3	SHP-3-1	SHP-3-4	SHP-3-1	SHP-3-1
16080474-018A	SHP-3	SHP-3-2	SHP-3-5	SHP-3-2	SHP-3-2
16080474-019A	SHP-3	SHP-3-3	SHP-3-6	SHP-3-3	SHP-3-3
16080533-001A	SMP-1	SMP-1-1	SMP-1-4	SMP-1-1	SMP-1-1
16080533-002A	SMP-1	SMP-1-2	SMP-1-5	SMP-1-2	SMP-1-2
16080533-003A	SMP-1	SMP-1-3	SMP-1-6	SMP-1-3	SMP-1-3
16080533-009A	SMP-2	SMP-2-1	SMP-2-4	SMP-2-1	SMP-2-1
16080533-010A	SMP-2	SMP-2-2	SMP-2-5	SMP-2-2	SMP-2-2
16080533-011A	SMP-2	SMP-2-3	SMP-2-6	SMP-2-3	SMP-2-3
16080533-017A	SMP-3	SMP-3-1	SMP-3-4	SMP-3-1	SMP-3-1
16080533-018A	SMP-3	SMP-3-2	SMP-3-5	SMP-3-2	SMP-3-2
16080533-019A	SMP-3	SMP-3-3	SMP-3-6	SMP-3-3	SMP-3-3
16080634-001A	SMP-4	SMP-4-1	SMP-4-5	SMP-4-1	SMP-4-1
16080634-002A	SMP-4	SMP-4-2	SMP-4-6	SMP-4-2	SMP-4-2
16080634-003A	SMP-4	SMP-4-3	SMP-4-7	SMP-4-3	SMP-4-3
16080634-004A	SMP-4	SMP-4-4	SMP-4-8	SMP-4-4	SMP-4-4
16080634-007A	SMP-5	SMP-5-1	SMP-5-5	SMP-5-1	SMP-5-1
16080634-008A	SMP-5	SMP-5-2	SMP-5-6	SMP-5-2	SMP-5-2
16080634-009A	SMP-5	SMP-5-3	SMP-5-7	SMP-5-3	SMP-5-3
16080634-010A	SMP-5	SMP-5-4	SMP-5-8	SMP-5-4	SMP-5-4
16080548-001A	SLP-1	SLP-1-1	SLP-1-4	SLP-1-1	SLP-1-1
16080548-002A	SLP-1	SLP-1-2	SLP-1-5	SLP-1-2	SLP-1-2
16080548-003A	SLP-1	SLP-1-3	SLP-1-6	SLP-1-3	SLP-1-3
16080548-009A	SLP-2	SLP-2-1	SLP-2-4	SLP-2-1	SLP-2-1
16080548-010A	SLP-2	SLP-2-2	SLP-2-5	SLP-2-2	SLP-2-2
16080548-011A	SLP-2	SLP-2-3	SLP-2-6	SLP-2-3	SLP-2-3
16080548-017A	SLP-3	SLP-3-1	SLP-3-4	SLP-3-1	SLP-3-1
16080548-018A	SLP-3	SLP-3-2	SLP-3-5	SLP-3-2	SLP-3-2
16080548-019A	SLP-3	SLP-3-3	SLP-3-6	SLP-3-3	SLP-3-3
16040041-001A	WHP-1	WHP-1-1	WHP-1-3	WHP-1-1	WHP-1-1

16040041-002A	WHP-1	WHP-1-2	WHP-1-4	WHP-1-2	WHP-1-2
16040115-001A	WHP-3	WHP-3-1	WHP-3-3	WHP-3-1	WHP-3-1
16040115-002A	WHP-3	WHP-3-2	WHP-3-4	WHP-3-2	WHP-3-2
16030982-001A	WHP-4	WHP-4-1	WHP-4-3	WHP-4-1	WHP-4-1
16030982-002A	WHP-4	WHP-4-2	WHP-4-4	WHP-4-2	WHP-4-2
16040116-001A	WMP-1	WMP-1-1	WMP-1-3	WMP-1-1	WMP-1-1
16040116-002A	WMP-1	WMP-1-2	WMP-1-4	WMP-1-2	WMP-1-2
16040117-001A	WMP-2	WMP-2-1	WMP-2-3	WMP-2-1	WMP-2-1
16040117-002A	WMP-2	*	WMP-2-4	*	WMP-2-2
16040118-001A	WMP-3	WMP-3-1	WMP-3-3	WMP-3-1	WMP-3-1
16040118-002A	WMP-3	WMP-3-2	WMP-3-4	WMP-3-2	WMP-3-2
16040120-001A	WLP-1	WLP-1-1	WLP-1-3	WLP-1-1	WLP-1-1
16040120-002A	WLP-1	*	WLP-1-4	*	WLP-1-2
16040119-001A	WLP-2	WLP-2-1	WLP-2-3	WLP-2-1	WLP-2-1
16040119-002A	WLP-2	WLP-2-2	WLP-2-4	WLP-2-2	WLP-2-2
16040121-001A	WLP-3	WLP-3-1	WLP-3-3	WLP-3-1	WLP-3-1
16040121-002A	WLP-3	WLP-3-2	WLP-3-4	WLP-3-2	WLP-3-2

* Blown Rupture disc on cylinder

Winter HP1										
			GPA 2103M				GPA 2186M			
			Winter HP1 2103 CP				Winter HP1 2186 CP			
		Measured	Sim 1	Sim 2	Sim 3	Sim 4	Sim 1	Sim 2	Sim 3	Sim 4
FGOR	Flash Gas to Oil Ratio (FGOR) - Scf/ST Bbl	177.6	230.5	231.7	233.4	232.9	227.6	225.5	231.0	227.5
	EOS Bubble Point at Tsep (psia)	274.6	259.6	271.2	259.3		257.4	269.7	256.9	
	bbl post flash liquids / bbl feed (inlet pressurized liquids)		0.8773	0.8768	0.8904		0.8797	0.8809	0.8928	
Sep. Bal.	Predicted Separator Gas / Measured Separator Gas	7971	100.4%	100.4%	100.3%		100.1%	100.1%	100.1%	
	Predicted Separator Oil / Measured Separator Oil	0.2719	95.5%	95.0%	97.1%		102.2%	102.2%	102.9%	
	Predicted Separator Water / Measured Separator Water	0.0146	83.6%	82.7%	85.9%		83.7%	82.8%	85.9%	
Mass Bal.	Volume of Dead Oil Required to match Mass Balance (Bbls.)		2.57	2.78	2.85		2.63	2.81	2.90	
			GPA 2103M				GPA 2186M			
			Winter HP1 2103 CV				Winter HP1 2186 CV			
		Measured	Sim 1	Sim 2	Sim 3	Sim 4	Sim 1	Sim 2	Sim 3	Sim 4
FGOR	Flash Gas to Oil Ratio (FGOR) - Scf/ST Bbl	177.6	227.4	228.7	230.2	230.7	202.4	200.9	205.5	212.2
	EOS Bubble Point at Tsep (psia)	274.6	254.0	265.8	253.8		223.0	233.5	222.5	
	bbl post flash liquids / bbl feed (inlet pressurized liquids)		0.8784	0.8778	0.8915		0.8905	0.8915	0.9024	
Sep. Bal.	Predicted Separator Gas / Measured Separator Gas	7971	100.4%	100.4%	100.4%		100.1%	100.1%	100.1%	
	Predicted Separator Oil / Measured Separator Oil	0.272	95.3%	94.8%	96.9%		102.6%	102.5%	103.3%	
	Predicted Separator Water / Measured Separator Water	0.015	83.6%	82.7%	85.9%		83.7%	82.8%	85.9%	
Mass Bal.	Volume of Dead Oil Required to match Mass Balance (Bbls.)		2.43	2.63	2.70		1.79	1.93	2.00	

Winter HP3										
			GPA 2103M				GPA 2186M			
			Winter HP3 2103 CP				Winter HP3 2186 CP			
		Measured	Sim 1	Sim 2	Sim 3	Sim 4	Sim 1	Sim 2	Sim 3	Sim 4
FGOR	Flash Gas to Oil Ratio (FGOR) - Scf/ST Bbl	334.0	269.9	270.7	271.5	283.3	271.5	269.4	274.9	277.6
	EOS Bubble Point at Tsep (psia)	258.0	233.1	240.5	231.5		238.9	248.3	237.8	
	bbl post flash liquids / bbl feed (inlet pressurized liquids)		0.8581	0.8578	0.8723		0.8584	0.8596	0.8726	
Sep. Bal.	Predicted Separator Gas / Measured Separator Gas	7898	99.7%	99.7%	99.6%		99.5%	99.5%	99.5%	
	Predicted Separator Oil / Measured Separator Oil	0.2180	111.1%	110.7%	112.8%		115.6%	115.4%	116.0%	
	Predicted Separator Water / Measured Separator Water	0.0120	90.9%	90.4%	93.0%		90.9%	90.4%	93.0%	
Mass Bal.	Volume of Dead Oil Required to match Mass Balance (Bbls.)		2.57	3.02	3.06		2.94	3.16	3.22	
			GPA 2103M				GPA 2186M			
			Winter HP3 2103 CV				Winter HP3 2186 CV			
		Measured	Sim 1	Sim 2	Sim 3	Sim 4	Sim 1	Sim 2	Sim 3	Sim 4
FGOR	Flash Gas to Oil Ratio (FGOR) - Scf/ST Bbl	334.0	266.1	267.4	268.2	276.9	259.0	257.0	262.5	264.2
	EOS Bubble Point at Tsep (psia)	258.0	232.5	240.4	231.4		234.0	243.5	233.0	
	bbl post flash liquids / bbl feed (inlet pressurized liquids)		0.8597	0.8591	0.8738		0.8642	0.8654	0.8781	
Sep. Bal.	Predicted Separator Gas / Measured Separator Gas	7898	99.7%	99.7%	99.6%		99.5%	99.5%	99.5%	
	Predicted Separator Oil / Measured Separator Oil	0.2180	111.0%	110.5%	112.6%		117.2%	116.4%	116.9%	
	Predicted Separator Water / Measured Separator Water	0.0120	90.9%	90.4%	93.0%		91.1%	90.4%	93.0%	
Mass Bal.	Volume of Dead Oil Required to match Mass Balance (Bbls.)		2.70	2.92	2.97		2.73	2.93	2.99	

Winter HP4										
			GPA 2103M				GPA 2186M			
			Winter HP4 2103 CP				Winter HP4 2186 CP			
Measured			Sim 1	Sim 2	Sim 3	Sim 4	Sim 1	Sim 2	Sim 3	Sim 4
FGOR	Flash Gas to Oil Ratio (FGOR) - Scf/ST Bbl	370.0	341.2	342.1	341.5	353.2	334.4	329.4	338.1	336.2
	EOS Bubble Point at Tsep (psia)	275.6	259.6	266.9	257.7		268.6	278.3	267.7	
	bbl post flash liquids / bbl feed (inlet pressurized liquids)		0.8257	0.8254	0.8414		0.8301	0.8323	0.8454	
Sep. Bal.	Predicted Separator Gas / Measured Separator Gas	7714	100.1%	100.2%	100.1%		100.0%	100.1%	100.0%	
	Predicted Separator Oil / Measured Separator Oil	0.6520	99.5%	99.2%	100.2%		100.9%	100.8%	101.1%	
	Predicted Separator Water / Measured Separator Water	0.0350	97.1%	97.2%	97.1%		97.1%	97.2%	97.1%	
Mass Bal.	Volume of Dead Oil Required to match Mass Balance (Bbls.)		6.73	7.30	7.54		6.79	7.10	7.65	
			GPA 2103M				GPA 2186M			
			Winter HP4 2103 CV				Winter HP4 2186 CV			
Measured			Sim 1	Sim 2	Sim 3	Sim 4	Sim 1	Sim 2	Sim 3	Sim 4
FGOR	Flash Gas to Oil Ratio (FGOR) - Scf/ST Bbl	370.0	341.8	342.5	342.2	351.1	326.4	323.8	329.8	330.1
	EOS Bubble Point at Tsep (psia)	275.6	261.1	269.1	259.5		262.8	272.7	261.7	
	bbl post flash liquids / bbl feed (inlet pressurized liquids)		0.8253	0.8250	0.8411		0.8335	0.8348	0.8487	
Sep. Bal.	Predicted Separator Gas / Measured Separator Gas	7714	100.2%	100.2%	100.1%		100.0%	100.0%	100.0%	
	Predicted Separator Oil / Measured Separator Oil	0.6520	99.2%	98.9%	99.9%		101.3%	101.2%	101.5%	
	Predicted Separator Water / Measured Separator Water	0.0350	97.1%	97.2%	97.1%		97.1%	97.2%	97.1%	
Mass Bal.	Volume of Dead Oil Required to match Mass Balance (Bbls.)		6.69	7.25	7.49		6.42	6.89	7.25	

Winter MP1										
			GPA 2103M				GPA 2186M			
			Winter MP1 2103 CP				Winter MP1 2186 CP			
Measured			Sim 1	Sim 2	Sim 3	Sim 4	Sim 1	Sim 2	Sim 3	Sim 4
FGOR	Flash Gas to Oil Ratio (FGOR) - Scf/ST Bbl	292.6	240.5	241.7	242.3	261.6	232.4	230.5	235.4	258.2
	EOS Bubble Point at Tsep (psia)	247.3	235.1	244.5	234.4		234.1	244.2	233.3	
	bbl post flash liquids / bbl feed (inlet pressurized liquids)		0.8710	0.8705	0.8840		0.8760	0.8771	0.8886	
Sep. Bal.	Predicted Separator Gas / Measured Separator Gas	7257	100.7%	100.7%	100.6%		100.3%	100.3%	100.3%	
	Predicted Separator Oil / Measured Separator Oil	0.5702	95.6%	95.2%	96.7%		99.3%	99.3%	99.8%	
	Predicted Separator Water / Measured Separator Water	0.0306	92.8%	92.6%	94.1%		92.8%	92.7%	94.1%	
Mass Bal.	Volume of Dead Oil Required to match Mass Balance (Bbls.)		5.37	5.78	5.89		5.25	5.63	5.80	
			GPA 2103M				GPA 2186M			
			Winter MP1 2103 CV				Winter MP1 2186 CV			
Measured			Sim 1	Sim 2	Sim 3	Sim 4	Sim 1	Sim 2	Sim 3	Sim 4
FGOR	Flash Gas to Oil Ratio (FGOR) - Scf/ST Bbl	292.6	237.6	238.7	239.5	258.2	233.0	229.5	236.3	246.5
	EOS Bubble Point at Tsep (psia)	247.3	236.4	245.6	235.5		239.2	249.6	238.7	
	bbl post flash liquids / bbl feed (inlet pressurized liquids)		0.8726	0.8721	0.8854		0.8759	0.8777	0.8885	
Sep. Bal.	Predicted Separator Gas / Measured Separator Gas	7257	100.6%	100.7%	100.6%		100.3%	100.3%	100.3%	
	Predicted Separator Oil / Measured Separator Oil	0.5702	95.9%	95.6%	97.0%		99.3%	99.3%	99.8%	
	Predicted Separator Water / Measured Separator Water	0.0306	92.8%	92.6%	94.1%		92.8%	92.7%	94.1%	
Mass Bal.	Volume of Dead Oil Required to match Mass Balance (Bbls.)		5.34	5.79	5.90		5.40	5.67	5.97	

Winter MP2										
			GPA 2103M				GPA 2186M			
			Winter MP2 2103 CP				Winter MP2 2186 CP			
Measured			Sim 1	Sim 2	Sim 3	Sim 4	Sim 1	Sim 2	Sim 3	Sim 4
FGOR	Flash Gas to Oil Ratio (FGOR) - Scf/ST Bbl	181.0	205.1	203.0	207.2	207.4	203.4	196.4	206.2	213.2
	EOS Bubble Point at Tsep (psia)	239.5	234.6	244.6	234.1		237.3	248.3	236.7	
	bbl post flash liquids / bbl feed (inlet pressurized liquids)		0.8887	0.8895	0.9004		0.8906	0.8939	0.9024	
Sep. Bal.	Predicted Separator Gas / Measured Separator Gas	6974	101.5%	101.5%	101.4%		101.1%	101.1%	101.1%	
	Predicted Separator Oil / Measured Separator Oil	0.6035	89.7%	89.4%	91.1%		93.6%	93.5%	94.3%	
	Predicted Separator Water / Measured Separator Water	0.0324	90.0%	90.0%	89.0%		90.0%	90.0%	89.0%	
Mass Bal.	Volume of Dead Oil Required to match Mass Balance (Bbls.)		2.58	2.60	2.94		2.70	2.54	3.08	
			GPA 2103M				GPA 2186M			
			Winter MP2 2103 CV				Winter MP2 2186 CV			
Measured			Sim 1	Sim 2	Sim 3	Sim 4	Sim 1	Sim 2	Sim 3	Sim 4
FGOR	Flash Gas to Oil Ratio (FGOR) - Scf/ST Bbl	181.0					196.9	193.1	199.6	207.4
	EOS Bubble Point at Tsep (psia)	239.5					232.5	243.4	231.9	
	bbl post flash liquids / bbl feed (inlet pressurized liquids)						0.8937	0.8956	0.9052	
Sep. Bal.	Predicted Separator Gas / Measured Separator Gas	6974					101.0%	101.1%	101.0%	
	Predicted Separator Oil / Measured Separator Oil	0.6035					93.8%	93.7%	94.5%	
	Predicted Separator Water / Measured Separator Water	0.0324					90.0%	90.0%	89.0%	
Mass Bal.	Volume of Dead Oil Required to match Mass Balance (Bbls.)						2.44	2.47	2.80	

Sample container rupture disc blow.

Winter MP3										
			GPA 2103M				GPA 2186M			
			Winter MP3 2103 CP				Winter MP3 2186 CP			
Measured			Sim 1	Sim 2	Sim 3	Sim 4	Sim 1	Sim 2	Sim 3	Sim 4
FGOR	Flash Gas to Oil Ratio (FGOR) - Scf/ST Bbl	233.1	192.0	193.0	194.2	204.1	190.3	188.9	193.3	197.9
	EOS Bubble Point at Tsep (psia)	241.2	222.1	231.5	221.5		222.8	233.2	222.3	
	bbl post flash liquids / bbl feed (inlet pressurized liquids)		0.8956	0.8951	0.9071		0.8974	0.8982	0.9087	
Sep. Bal.	Predicted Separator Gas / Measured Separator Gas	6896	100.6%	100.7%	100.6%		100.3%	100.3%	100.3%	
	Predicted Separator Oil / Measured Separator Oil	0.5029	95.7%	95.4%	96.7%		99.4%	99.4%	99.8%	
	Predicted Separator Water / Measured Separator Water	0.0270	90.8%	90.7%	90.9%		90.8%	90.7%	90.9%	
Mass Bal.	Volume of Dead Oil Required to match Mass Balance (Bbls.)		0.75	0.84	0.91		0.66	0.83	0.95	
			GPA 2103M				GPA 2186M			
			Winter MP3 2103 CV				Winter MP3 2186 CV			
Measured			Sim 1	Sim 2	Sim 3	Sim 4	Sim 1	Sim 2	Sim 3	Sim 4
FGOR	Flash Gas to Oil Ratio (FGOR) - Scf/ST Bbl	233.1	188.8	189.8	190.9	200.1	188.6	187.0	191.5	195.8
	EOS Bubble Point at Tsep (psia)	241.2	221.0	230.7	220.4		223.0	233.5	222.5	
	bbl post flash liquids / bbl feed (inlet pressurized liquids)		0.8973	0.8968	0.9087		0.8982	0.8991	0.9095	
Sep. Bal.	Predicted Separator Gas / Measured Separator Gas	6896	100.6%	100.6%	100.5%		100.3%	100.3%	100.3%	
	Predicted Separator Oil / Measured Separator Oil	0.5029	96.0%	95.7%	97.0%		99.5%	99.5%	99.9%	
	Predicted Separator Water / Measured Separator Water	0.0270	90.8%	90.7%	90.9%		90.8%	90.7%	90.9%	
Mass Bal.	Volume of Dead Oil Required to match Mass Balance (Bbls.)		0.67	0.77	0.83		0.74	0.78	0.90	

Winter LP1										
			GPA 2103M				GPA 2186M			
			Winter LP1 2103 CP				Winter LP1 2186 CP			
Measured			Sim 1	Sim 2	Sim 3	Sim 4	Sim 1	Sim 2	Sim 3	Sim 4
FGOR	Flash Gas to Oil Ratio (FGOR) - Scf/ST Bbl	146.9	150.9	152.0	152.6	171.0	147.2	145.9	149.4	132.8
	EOS Bubble Point at Tsep (psia)	190.6	180.7	188.3	180.4		179.7	186.6	178.4	
	bbl post flash liquids / bbl feed (inlet pressurized liquids)		0.9154	0.9148	0.9251		0.9181	0.9189	0.9279	
Sep. Bal.	Predicted Separator Gas / Measured Separator Gas	7175	101.1%	101.1%	101.0%		100.7%	100.7%	100.7%	
	Predicted Separator Oil / Measured Separator Oil	0.6419	93.4%	93.2%	94.7%		97.5%	97.5%	98.1%	
	Predicted Separator Water / Measured Separator Water	0.0345	89.7%	89.7%	88.6%		89.8%	89.8%	88.7%	
Mass Bal.	Volume of Dead Oil Required to match Mass Balance (Bbls.)		1.29	1.44	1.51		1.06	1.30	1.43	
			GPA 2103M				GPA 2186M			
			Winter LP1 2103 CV				Winter LP1 2186 CV			
Measured			Sim 1	Sim 2	Sim 3	Sim 4	Sim 1	Sim 2	Sim 3	Sim 4
FGOR	Flash Gas to Oil Ratio (FGOR) - Scf/ST Bbl	146.9	145.3	146.5	146.9	171.0	143.6	142.6	145.9	157.7
	EOS Bubble Point at Tsep (psia)	190.6	174.6	181.7	174.2		177.0	185.2	176.7	
	bbl post flash liquids / bbl feed (inlet pressurized liquids)		0.9182	0.9176	0.9276		0.9200	0.9206	0.9293	
Sep. Bal.	Predicted Separator Gas / Measured Separator Gas	7175	101.1%	101.1%	101.0%		100.6%	100.7%	100.6%	
	Predicted Separator Oil / Measured Separator Oil	0.6419	93.5%	93.3%	94.8%		97.6%	97.6%	98.2%	
	Predicted Separator Water / Measured Separator Water	0.0345	89.1%	89.7%	88.6%		89.1%	89.8%	88.7%	
Mass Bal.	Volume of Dead Oil Required to match Mass Balance (Bbls.)		1.08	1.20	1.26		0.95	1.18	1.30	

Winter LP2										
			GPA 2103M				GPA 2186M			
			Winter LP2 2103 CP				Winter LP2 2186 CP			
Measured			Sim 1	Sim 2	Sim 3	Sim 4	Sim 1	Sim 2	Sim 3	Sim 4
FGOR	Flash Gas to Oil Ratio (FGOR) - Scf/ST Bbl	182.5	145.1	145.5	147.1	156.7	142.3	140.4	143.8	148.3
	EOS Bubble Point at Tsep (psia)	190.8	184.0	192.1	183.8		181.2	188.2	179.9	
	bbl post flash liquids / bbl feed (inlet pressurized liquids)		0.9188	0.9186	0.9282		0.9209	0.9220	0.9306	
Sep. Bal.	Predicted Separator Gas / Measured Separator Gas	6137	101.0%	101.0%	100.9%		100.6%	100.6%	100.5%	
	Predicted Separator Oil / Measured Separator Oil	0.5107	94.2%	94.0%	95.6%		98.3%	98.4%	99.1%	
	Predicted Separator Water / Measured Separator Water	0.0274	87.9%	87.9%	86.6%		88.0%	87.9%	86.7%	
Mass Bal.	Volume of Dead Oil Required to match Mass Balance (Bbls.)									
			GPA 2103M				GPA 2186M			
			Winter LP2 2103 CV				Winter LP2 2186 CV			
Measured			Sim 1	Sim 2	Sim 3	Sim 4	Sim 1	Sim 2	Sim 3	Sim 4
FGOR	Flash Gas to Oil Ratio (FGOR) - Scf/ST Bbl	182.5					137.9	135.7	138.9	142.6
	EOS Bubble Point at Tsep (psia)	190.8					173.7	186.2	177.4	
	bbl post flash liquids / bbl feed (inlet pressurized liquids)						0.9232	0.9246	0.9330	
Sep. Bal.	Predicted Separator Gas / Measured Separator Gas	6137					100.5%	100.5%	100.5%	
	Predicted Separator Oil / Measured Separator Oil	0.5107					98.9%	99.0%	99.7%	
	Predicted Separator Water / Measured Separator Water	0.0274					88.0%	87.9%	86.7%	
Mass Bal.	Volume of Dead Oil Required to match Mass Balance (Bbls.)									

Sample container rupture disc blow.

Winter LP3										
			GPA 2103M				GPA 2186M			
			Winter LP3 2103 CP				Winter LP3 2186 CP			
Measured			Sim 1	Sim 2	Sim 3	Sim 4	Sim 1	Sim 2	Sim 3	Sim 4
FGOR	Flash Gas to Oil Ratio (FGOR) - Scf/ST Bbl	181.9	148.6	149.7	150.2	163.7	142.6	141.6	144.9	151.3
	EOS Bubble Point at Tsep (psia)	192.3	182.1	189.4	181.5		177.1	185.0	176.7	
	bbl post flash liquids / bbl feed (inlet pressurized liquids)		0.9173	0.9167	0.9268		0.9209	0.9216	0.9302	
Sep. Bal.	Predicted Separator Gas / Measured Separator Gas	7507	100.9%	101.0%	100.8%		100.5%	100.6%	100.5%	
	Predicted Separator Oil / Measured Separator Oil	0.4825	92.1%	91.9%	93.6%		97.4%	97.4%	98.1%	
	Predicted Separator Water / Measured Separator Water	0.0259	87.2%	86.9%	87.6%		87.3%	87.0%	87.6%	
Mass Bal.	Volume of Dead Oil Required to match Mass Balance (Bbls.)		4.64	5.02	4.98		3.81	4.69	4.69	
			GPA 2103M				GPA 2186M			
			Winter LP3 2103 CV				Winter LP3 2186 CV			
Measured			Sim 1	Sim 2	Sim 3	Sim 4	Sim 1	Sim 2	Sim 3	Sim 4
FGOR	Flash Gas to Oil Ratio (FGOR) - Scf/ST Bbl	181.9	145.6	146.8	147.3	160.6	141.2	140.1	143.4	149.2
	EOS Bubble Point at Tsep (psia)	192.3	178.1	185.6	177.8		177.1	185.2	176.6	
	bbl post flash liquids / bbl feed (inlet pressurized liquids)		0.9186	0.9180	0.9280		0.9217	0.9224	0.9310	
Sep. Bal.	Predicted Separator Gas / Measured Separator Gas	7507	100.9%	101.0%	100.8%		100.2%	100.5%	100.5%	
	Predicted Separator Oil / Measured Separator Oil	0.4825	92.2%	92.0%	93.7%		102.9%	97.6%	98.2%	
	Predicted Separator Water / Measured Separator Water	0.0259	87.2%	86.9%	87.6%		0.0%	87.0%	87.6%	
Mass Bal.	Volume of Dead Oil Required to match Mass Balance (Bbls.)		4.37	4.75	4.71		3.79	4.67	4.67	

For the Summer testing results, sample “3” (e.g., Summer HP1-3 CP) was collected from the separator oil box oil level sight glass, and sample 1 and 2 were collected from sample probes.

Summer HP1										
			GPA 2103M				GPA 2186M			
			Summer HP1-1 CV				Summer HP1-1 CV			
Measured			Sim 1	Sim 2	Sim 3	Sim 4	Sim 1	Sim 2	Sim 3	Sim 4
FGOR	Flash Gas to Oil Ratio (FGOR) - Scf/ST Bbl	404.6	360.2	360.4	357.8	308.6	332.9	330.6	334.2	290.6
	EOS Bubble Point at Tsep (psia)	279.8	220.4	227.5	218.6		209.6	218.2	208.1	
	bbl post flash liquids / bbl feed (inlet pressurized liquids)		0.8089	0.8090	0.8258		0.8223	0.8236	0.8373	
Sep. Bal.	Predicted Separator Gas / Measured Separator Gas	10896	99.8%	99.9%	99.7%		99.7%	99.7%	99.6%	
	Predicted Separator Oil / Measured Separator Oil	0.2540	108.9%	108.2%	111.4%		113.3%	113.8%	115.6%	
	Predicted Separator Water / Measured Separator Water	0.0130	87.9%	87.4%	88.0%		87.9%	87.5%	88.0%	
Mass Bal.	Volume of Dead Oil Required to match Mass Balance (Bbls.)		3.66	3.34	3.83		3.37	3.04	3.53	
Summer HP1-2 CP										
			GPA 2103M				GPA 2186M			
			Summer HP1-2 CP				Summer HP1-2 CP			
Measured			Sim 1	Sim 2	Sim 3	Sim 4	Sim 1	Sim 2	Sim 3	Sim 4
FGOR	Flash Gas to Oil Ratio (FGOR) - Scf/ST Bbl	404.6	440.5	436.5	431.7	363.3	397.3	394.0	398.5	340.4
	EOS Bubble Point at Tsep (psia)	279.8	256.8	265.4	254.8		243.2	251.4	241.5	
	bbl post flash liquids / bbl feed (inlet pressurized liquids)		0.7754	0.7775	0.7960		0.7952	0.7968	0.8112	
Sep. Bal.	Predicted Separator Gas / Measured Separator Gas	10896	100.0%	100.0%	99.9%		99.8%	99.8%	99.7%	
	Predicted Separator Oil / Measured Separator Oil	0.2540	104.0%	104.1%	107.7%		110.1%	110.7%	112.6%	
	Predicted Separator Water / Measured Separator Water	0.0130	87.8%	87.4%	88.0%		87.9%	87.5%	88.0%	
Mass Bal.	Volume of Dead Oil Required to match Mass Balance (Bbls.)		4.97	4.40	5.02		4.44	4.01	4.64	
Summer HP1-3 CP										
			GPA 2103M				GPA 2186M			
			Summer HP1-3 CP				Summer HP1-3 CP			
Measured			Sim 1	Sim 2	Sim 3	Sim 4	Sim 1	Sim 2	Sim 3	Sim 4
FGOR	Flash Gas to Oil Ratio (FGOR) - Scf/ST Bbl	404.6	409.4	431.1	406.3	344.4	380.4	377.7	381.2	326.4
	EOS Bubble Point at Tsep (psia)	279.8	248.0	259.3	246.5		234.1	244.4	233.6	
	bbl post flash liquids / bbl feed (inlet pressurized liquids)		0.7888	0.7804	0.8067		0.8025	0.8039	0.8185	
Sep. Bal.	Predicted Separator Gas / Measured Separator Gas	10896	99.9%	99.9%	99.8%		99.7%	99.8%	99.7%	
	Predicted Separator Oil / Measured Separator Oil	0.2540	107.5%	106.9%	109.3%		113.2%	112.0%	114.0%	
	Predicted Separator Water / Measured Separator Water	0.0130	88.1%	87.4%	88.0%		88.1%	87.5%	88.0%	
Mass Bal.	Volume of Dead Oil Required to match Mass Balance (Bbls.)		4.53	4.46	4.73		4.07	3.85	4.43	

Summer HP2										
			GPA 2103M				GPA 2186M			
			Summer HP2-1 CP				Summer HP2-1 CP			
		Measured	Sim 1	Sim 2	Sim 3	Sim 4	Sim 1	Sim 2	Sim 3	Sim 4
FGOR	Flash Gas to Oil Ratio (FGOR) - Scf/ST Bbl	299.9	421.8	415.2	416.9	338.1	379.0	376.4	379.7	314.5
	EOS Bubble Point at Tsep (psia)	276.5	273.8	283.7	272.1		256.7	266.2	255.4	
	bbl post flash liquids / bbl feed (inlet pressurized liquids)		0.7827	0.7852	0.8012		0.8022	0.8036	0.8181	
Sep. Bal.	Predicted Separator Gas / Measured Separator Gas	8907	101.7%		101.1%		101.2%		100.8%	
	Predicted Separator Oil / Measured Separator Oil	0.6310	95.6%		91.1%		96.9%		93.9%	
	Predicted Separator Water / Measured Separator Water	0.0320	98.1%		93.1%		98.1%		93.1%	
Mass Bal.	Volume of Dead Oil Required to match Mass Balance (Bbls.)		5.60	4.65	5.95		4.66	4.09	4.98	
			GPA 2103M				GPA 2186M			
			Summer HP2-2 CV				Summer HP2-2 CV			
		Measured	Sim 1	Sim 2	Sim 3	Sim 4	Sim 1	Sim 2	Sim 3	Sim 4
FGOR	Flash Gas to Oil Ratio (FGOR) - Scf/ST Bbl	299.9	359.9	360.5	355.9	300.5	376.4	373.6	377.3	313.7
	EOS Bubble Point at Tsep (psia)	276.5	201.5	208.3	200.6		237.3	246.1	236.4	
	bbl post flash liquids / bbl feed (inlet pressurized liquids)		0.8048	0.8046	0.8217		0.8020	0.8034	0.8178	
Sep. Bal.	Predicted Separator Gas / Measured Separator Gas	8907	100.9%		100.9%		100.8%		100.8%	
	Predicted Separator Oil / Measured Separator Oil	0.6310	97.0%		92.2%		93.3%		93.7%	
	Predicted Separator Water / Measured Separator Water	0.0320	98.1%		93.1%		93.2%		93.1%	
Mass Bal.	Volume of Dead Oil Required to match Mass Balance (Bbls.)		2.92	2.57	3.10		4.11	3.60	4.40	
			GPA 2103M				GPA 2186M			
			Summer HP2-3 CV				Summer HP2-3 CV			
		Measured	Sim 1	Sim 2	Sim 3	Sim 4	Sim 1	Sim 2	Sim 3	Sim 4
FGOR	Flash Gas to Oil Ratio (FGOR) - Scf/ST Bbl	299.9	280.5	281.1	277.7	234.4	347.3	344.8	348.1	292.5
	EOS Bubble Point at Tsep (psia)	276.5	200.7	208.0	199.8		214.0	221.6	213.3	
	bbl post flash liquids / bbl feed (inlet pressurized liquids)		0.8442	0.8440	0.8599		0.8136	0.8149	0.8289	
Sep. Bal.	Predicted Separator Gas / Measured Separator Gas	8907	100.0%		100.4%		100.8%		100.7%	
	Predicted Separator Oil / Measured Separator Oil	0.6310	99.5%		96.2%		97.7%		94.5%	
	Predicted Separator Water / Measured Separator Water	0.0320	98.1%		93.2%		98.1%		93.1%	
Mass Bal.	Volume of Dead Oil Required to match Mass Balance (Bbls.)		1.94	1.70	2.04		3.19	2.77	3.41	

Summer HP3										
			GPA 2103M				GPA 2186M			
			Summer HP3-1 CV				Summer HP3-1 CV			
Measured			Sim 1	Sim 2	Sim 3	Sim 4	Sim 1	Sim 2	Sim 3	Sim 4
FGOR	Flash Gas to Oil Ratio (FGOR) - Scf/ST Bbl	332.8	342.1	342.4	339.8	278.1	273.0	270.8	274.5	230.4
	EOS Bubble Point at Tsep (psia)	277.4	238.7	247.5	237.6		177.4	183.6	177.3	
	bbl post flash liquids / bbl feed (inlet pressurized liquids)		0.8158	0.8158	0.8328		0.8465	0.8478	0.8603	
Sep. Bal.	Predicted Separator Gas / Measured Separator Gas	7762	101.1%	101.1%	101.0%		100.6%	100.7%	100.6%	
	Predicted Separator Oil / Measured Separator Oil	0.4890	89.2%	89.3%	90.9%		93.9%	94.2%	94.7%	
	Predicted Separator Water / Measured Separator Water	0.0250	90.1%	89.9%	90.0%		90.1%	89.9%	90.1%	
Mass Bal.	Volume of Dead Oil Required to match Mass Balance (Bbls.)		0.28	0.29	0.28					
			GPA 2103M				GPA 2186M			
			Summer HP3-2 CP				Summer HP3-2 CP			
Measured			Sim 1	Sim 2	Sim 3	Sim 4	Sim 1	Sim 2	Sim 3	Sim 4
FGOR	Flash Gas to Oil Ratio (FGOR) - Scf/ST Bbl	332.8	374.8	366.1	373.1	297.2	338.6	336.2	339.9	233.3
	EOS Bubble Point at Tsep (psia)	277.4	281.1	292.5	279.4		261.7	272.3	260.4	
	bbl post flash liquids / bbl feed (inlet pressurized liquids)		0.8025	0.8065	0.8203		0.8206	0.8219	0.8360	
Sep. Bal.	Predicted Separator Gas / Measured Separator Gas	7762	101.2%	101.2%	101.2%		100.9%	100.9%	100.9%	
	Predicted Separator Oil / Measured Separator Oil	0.4890	88.6%	88.3%	89.9%		92.7%	92.5%	93.3%	
	Predicted Separator Water / Measured Separator Water	0.0250	90.1%	89.8%	90.0%		90.1%	89.9%	90.0%	
Mass Bal.	Volume of Dead Oil Required to match Mass Balance (Bbls.)		0.63	0.54	0.67		0.32	0.31	0.34	
			GPA 2103M				GPA 2186M			
			Summer HP3-3 CP				Summer HP3-3 CP			
Measured			Sim 1	Sim 2	Sim 3	Sim 4	Sim 1	Sim 2	Sim 3	Sim 4
FGOR	Flash Gas to Oil Ratio (FGOR) - Scf/ST Bbl	332.8	376.8	369.0	373.6	297.9	341.5	338.7	343.0	279.6
	EOS Bubble Point at Tsep (psia)	277.4	276.9	287.5	275.1		264.1	274.8	263.1	
	bbl post flash liquids / bbl feed (inlet pressurized liquids)		0.8023	0.8053	0.8199		0.8195	0.8209	0.8351	
Sep. Bal.	Predicted Separator Gas / Measured Separator Gas	7762	101.2%	101.2%	101.2%		100.9%	100.9%	100.9%	
	Predicted Separator Oil / Measured Separator Oil	0.4890	88.1%	88.2%	89.8%		92.7%	92.6%	93.3%	
	Predicted Separator Water / Measured Separator Water	0.0250	90.1%	89.8%	90.0%		90.1%	89.9%	90.0%	
Mass Bal.	Volume of Dead Oil Required to match Mass Balance (Bbls.)		0.65	0.58	0.68		0.35	0.34	0.38	

Summer MP1										
			GPA 2103M				GPA 2186M			
			Summer MP1-1 CP				Summer MP1-1 CP			
		Measured	Sim 1	Sim 2	Sim 3	Sim 4	Sim 1	Sim 2	Sim 3	Sim 4
FGOR	Flash Gas to Oil Ratio (FGOR) - Scf/ST Bbl	294.2	303.0	303.3	301.3	254.1	288.0		289.5	247.3
	EOS Bubble Point at Tsep (psia)	241.7	223.1	231.4	222.2		219.0	228.6	218.3	
	bbl post flash liquids / bbl feed (inlet pressurized liquids)		0.8364	0.8364	0.8526		0.8450		0.8597	
Sep. Bal.	Predicted Separator Gas / Measured Separator Gas	8204	100.6%	100.7%	100.6%		100.4%	100.5%	100.4%	
	Predicted Separator Oil / Measured Separator Oil	0.6430	94.9%	94.5%	95.6%		97.1%	97.0%	97.3%	
	Predicted Separator Water / Measured Separator Water	0.0320	95.2%	95.2%	95.2%		95.2%	95.2%	95.2%	
Mass Bal.	Volume of Dead Oil Required to match Mass Balance (Bbls.)		3.27	3.61	3.50		3.12	4.25	3.35	
			GPA 2103M				GPA 2186M			
			Summer MP1-2 CV				Summer MP1-2 CV			
		Measured	Sim 1	Sim 2	Sim 3	Sim 4	Sim 1	Sim 2	Sim 3	Sim 4
FGOR	Flash Gas to Oil Ratio (FGOR) - Scf/ST Bbl	294.2	283.7	284.2	282.3	243.9	273.6	269.4	272.9	235.6
	EOS Bubble Point at Tsep (psia)	241.7	200.7	207.6	200.0		195.1	203.1	194.9	
	bbl post flash liquids / bbl feed (inlet pressurized liquids)		0.8444	0.8443	0.8599		0.8503	0.8526	0.8658	
Sep. Bal.	Predicted Separator Gas / Measured Separator Gas	8204	100.5%	100.6%	100.5%		100.4%	100.4%	100.4%	
	Predicted Separator Oil / Measured Separator Oil	0.6430	95.6%	95.3%	96.3%		97.5%	97.4%	97.6%	
	Predicted Separator Water / Measured Separator Water	0.0320	95.2%	95.2%	93.8%		95.2%	95.2%	95.2%	
Mass Bal.	Volume of Dead Oil Required to match Mass Balance (Bbls.)		2.56	2.70	2.74		2.46	2.47	2.56	
			GPA 2103M				GPA 2186M			
			Summer MP1-3 CV				Summer MP1-3 CV			
		Measured	Sim 1	Sim 2	Sim 3	Sim 4	Sim 1	Sim 2	Sim 3	Sim 4
FGOR	Flash Gas to Oil Ratio (FGOR) - Scf/ST Bbl	294.2	321.7	315.8	321.2	267.3	278.4	276.6	279.9	240.6
	EOS Bubble Point at Tsep (psia)	241.7	277.2	287.3	275.5		204.8	213.4	204.3	
	bbl post flash liquids / bbl feed (inlet pressurized liquids)		0.8229	0.8314	0.8454		0.8487	0.8498	0.8632	
Sep. Bal.	Predicted Separator Gas / Measured Separator Gas	8204	100.8%	100.9%	100.8%		100.4%	100.4%	100.4%	
	Predicted Separator Oil / Measured Separator Oil	0.6430	93.9%	93.6%	94.7%		97.4%	97.2%	97.6%	
	Predicted Separator Water / Measured Separator Water	0.0320	95.2%	95.1%	95.2%		95.2%	95.2%	95.2%	
Mass Bal.	Volume of Dead Oil Required to match Mass Balance (Bbls.)		4.13	4.20	4.50		2.69	2.78	2.89	

Summer MP2										
			GPA 2103M				GPA 2186M			
			Summer MP2-1 CV				Summer MP2-1 CV			
Measured			Sim 1	Sim 2	Sim 3	Sim 4	Sim 1	Sim 2	Sim 3	Sim 4
FGOR	Flash Gas to Oil Ratio (FGOR) - Scf/ST Bbl	308.1	303.7	303.8	302.3	254.6	277.6	275.7	279.3	236.5
	EOS Bubble Point at Tsep (psia)	240.0	217.9	224.1	215.2		202.6	209.6	200.6	
	bbl post flash liquids / bbl feed (inlet pressurized liquids)		0.8348	0.8349	0.8508		0.8481	0.8492	0.8623	
Sep. Bal.	Predicted Separator Gas / Measured Separator Gas	7898	100.4%	100.4%	100.3%		100.1%	100.1%	100.1%	
	Predicted Separator Oil / Measured Separator Oil	0.7460	98.0%	97.7%	98.5%		100.1%	100.0%	100.1%	
	Predicted Separator Water / Measured Separator Water	0.0380	95.6%	95.5%	94.7%		95.6%	95.5%	95.5%	
Mass Bal.	Volume of Dead Oil Required to match Mass Balance (Bbls.)		1.09	1.25	1.17		0.69	0.70	0.76	
			GPA 2103M				GPA 2186M			
			Summer MP2-2 CP				Summer MP2-2 CP			
Measured			Sim 1	Sim 2	Sim 3	Sim 4	Sim 1	Sim 2	Sim 3	Sim 4
FGOR	Flash Gas to Oil Ratio (FGOR) - Scf/ST Bbl	308.1	310.4	310.5	308.6	258.3	292.2	289.9	293.7	246.9
	EOS Bubble Point at Tsep (psia)	240.0	221.7	228.1	219.0		218.3	224.8	215.8	
	bbl post flash liquids / bbl feed (inlet pressurized liquids)		0.8317	0.8318	0.8481		0.8419	0.8432	0.8567	
Sep. Bal.	Predicted Separator Gas / Measured Separator Gas	7898	100.4%	100.5%	100.4%		100.2%	100.2%	100.2%	
	Predicted Separator Oil / Measured Separator Oil	0.7460	97.6%	97.3%	98.1%		99.6%	99.5%	99.7%	
	Predicted Separator Water / Measured Separator Water	0.0380	95.6%	95.5%	95.5%		95.6%	95.5%	94.7%	
Mass Bal.	Volume of Dead Oil Required to match Mass Balance (Bbls.)		1.21	1.37	1.29		1.01	1.11	1.10	
			GPA 2103M				GPA 2186M			
			Summer MP2-3 CP				Summer MP2-3 CP			
Measured			Sim 1	Sim 2	Sim 3	Sim 4	Sim 1	Sim 2	Sim 3	Sim 4
FGOR	Flash Gas to Oil Ratio (FGOR) - Scf/ST Bbl	308.1	314.4	314.7	313.0	264.0	297.5	297.3	299.2	250.7
	EOS Bubble Point at Tsep (psia)	240.0	231.1	237.0	227.8		225.9	232.7	223.5	
	bbl post flash liquids / bbl feed (inlet pressurized liquids)		0.8309	0.8309	0.8468		0.8399	0.8400	0.8548	
Sep. Bal.	Predicted Separator Gas / Measured Separator Gas	7898	100.4%	100.5%	100.4%		100.2%	100.3%	100.2%	
	Predicted Separator Oil / Measured Separator Oil	0.7460	98.0%	97.6%	98.5%		99.5%	99.4%	99.6%	
	Predicted Separator Water / Measured Separator Water	0.0380	95.6%	95.5%	94.7%		95.6%	95.5%	94.7%	
Mass Bal.	Volume of Dead Oil Required to match Mass Balance (Bbls.)		1.40	1.59	1.51		1.14	1.16	1.25	

Summer MP3										
			GPA 2103M				GPA 2186M			
			Summer MP3-1 CP				Summer MP3-1 CP			
		Measured	Sim 1	Sim 2	Sim 3	Sim 4	Sim 1	Sim 2	Sim 3	Sim 4
FGOR	Flash Gas to Oil Ratio (FGOR) - Scf/ST Bbl	308.9	311.7	311.5	310.5	257.5	299.0	295.7	300.3	251.0
	EOS Bubble Point at Tsep (psia)	246.3	228.3	247.1	236.8		231.3	250.8	239.6	
	bbl post flash liquids / bbl feed (inlet pressurized liquids)		0.8309	0.8310	0.8469		0.8394	0.8461	0.8545	
Sep. Bal.	Predicted Separator Gas / Measured Separator Gas	7614	101.0%	101.0%	100.9%		100.7%	100.7%	100.7%	
	Predicted Separator Oil / Measured Separator Oil	0.5219	91.8%	91.4%	92.9%		95.3%	95.2%	96.0%	
	Predicted Separator Water / Measured Separator Water	0.0263	90.1%	90.0%	89.1%		90.1%	90.0%	87.5%	
Mass Bal.	Volume of Dead Oil Required to match Mass Balance (Bbls.)		0.11	0.10	0.10		0.01		0.01	
			GPA 2103M				GPA 2186M			
			Summer MP3-2 CV				Summer MP3-2 CV			
		Measured	Sim 1	Sim 2	Sim 3	Sim 4	Sim 1	Sim 2	Sim 3	Sim 4
FGOR	Flash Gas to Oil Ratio (FGOR) - Scf/ST Bbl	308.9	293.4	281.4	291.6	244.7	272.0	272.9	273.8	230.6
	EOS Bubble Point at Tsep (psia)	246.3	210.4	223.8	214.5		198.9	212.7	203.3	
	bbl post flash liquids / bbl feed (inlet pressurized liquids)		0.8383	0.8371	0.8542		0.8498	0.8495	0.8639	
Sep. Bal.	Predicted Separator Gas / Measured Separator Gas	7614	100.9%	101.0%	100.8%		100.6%	100.6%	100.6%	
	Predicted Separator Oil / Measured Separator Oil	0.5219	92.3%	91.9%	93.5%		96.0%	95.9%	96.5%	
	Predicted Separator Water / Measured Separator Water	0.0263	90.1%	90.0%	87.5%		90.1%	90.0%	89.1%	
Mass Bal.	Volume of Dead Oil Required to match Mass Balance (Bbls.)									
			GPA 2103M				GPA 2186M			
			Summer MP3-3 CV				Summer MP3-3 CV			
		Measured	Sim 1	Sim 2	Sim 3	Sim 4	Sim 1	Sim 2	Sim 3	Sim 4
FGOR	Flash Gas to Oil Ratio (FGOR) - Scf/ST Bbl	308.9	297.2	297.5	295.9	246.9	264.1	261.8	265.9	224.6
	EOS Bubble Point at Tsep (psia)	246.3	212.5	226.1	216.9		191.6	204.2	196.0	
	bbl post flash liquids / bbl feed (inlet pressurized liquids)		0.8365	0.8365	0.8523		0.8533	0.8545	0.8672	
Sep. Bal.	Predicted Separator Gas / Measured Separator Gas	7614	100.9%	101.0%	100.9%		100.6%	100.6%	100.6%	
	Predicted Separator Oil / Measured Separator Oil	0.5219	92.1%	91.7%	93.3%		96.3%	96.2%	96.8%	
	Predicted Separator Water / Measured Separator Water	0.0263	90.1%	90.0%	87.5%		90.1%	90.0%	89.1%	
Mass Bal.	Volume of Dead Oil Required to match Mass Balance (Bbls.)									

Summer MP4-A										
			GPA 2103M				GPA 2186M			
			Summer MP4-1 CV				Summer MP4-1 CV			
Measured			Sim 1	Sim 2	Sim 3	Sim 4	Sim 1	Sim 2	Sim 3	Sim 4
FGOR	Flash Gas to Oil Ratio (FGOR) - Scf/ST Bbl	321.7	318.3	318.6	318.0	299.6	296.8	294.3	298.9	257.4
	EOS Bubble Point at Tsep (psia)	241.3	228.1	233.9	225.0		212.8	219.4	210.2	
	bbl post flash liquids / bbl feed (inlet pressurized liquids)		0.8299	0.8298	0.8459		0.8405	0.8418	0.8553	
Sep. Bal.	Predicted Separator Gas / Measured Separator Gas	8821	100.5%	100.6%	100.5%		100.3%	100.4%	100.3%	
	Predicted Separator Oil / Measured Separator Oil	0.5786	95.0%	94.6%	95.7%		97.4%	97.3%	97.6%	
	Predicted Separator Water / Measured Separator Water	0.0291	95.1%	95.0%	96.1%		95.1%	95.0%	96.1%	
Mass Bal.	Volume of Dead Oil Required to match Mass Balance (Bbls.)		3.62	3.80	3.90		3.12	3.25	3.36	
			GPA 2103M				GPA 2186M			
			Summer MP4-2 CP				Summer MP4-2 CP			
Measured			Sim 1	Sim 2	Sim 3	Sim 4	Sim 1	Sim 2	Sim 3	Sim 4
FGOR	Flash Gas to Oil Ratio (FGOR) - Scf/ST Bbl	321.7	269.3	269.6	269.2	233.9	277.1	276.1	279.3	249.7
	EOS Bubble Point at Tsep (psia)	241.3	200.6	206.1	198.0		201.7	209.6	199.4	
	bbl post flash liquids / bbl feed (inlet pressurized liquids)		0.8521	0.8521	0.8672		0.8496	0.8503	0.8641	
Sep. Bal.	Predicted Separator Gas / Measured Separator Gas	8821	100.3%	100.4%	100.3%		100.3%	100.3%	100.3%	
	Predicted Separator Oil / Measured Separator Oil	0.5786	97.1%	96.7%	97.6%		98.3%	98.2%	98.5%	
	Predicted Separator Water / Measured Separator Water	0.0291	95.1%	95.0%	96.1%		95.1%	95.0%	94.6%	
Mass Bal.	Volume of Dead Oil Required to match Mass Balance (Bbls.)		2.36	2.48	2.55		2.63	2.77	2.85	

Summer MP4-B										
			GPA 2103M				GPA 2186M			
			Summer MP4-3 CV				Summer MP4-3 CV			
		Measured	Sim 1	Sim 2	Sim 3	Sim 4	Sim 1	Sim 2	Sim 3	Sim 4
FGOR	Flash Gas to Oil Ratio (FGOR) - Scf/ST Bbl	321.7	280.6	278.5	277.4	243.4	285.5	283.0	287.6	249.7
	EOS Bubble Point at Tsep (psia)	241.3	201.6	206.8	198.9		203.5	209.6	200.9	
	bbl post flash liquids / bbl feed (inlet pressurized liquids)		0.8464	0.8477	0.8629		0.8452	0.8467	0.8598	
Sep. Bal.	Predicted Separator Gas / Measured Separator Gas	8821	100.4%	100.4%	100.3%		100.3%	100.3%	100.3%	
	Predicted Separator Oil / Measured Separator Oil	0.5786	96.6%	96.2%	97.3%		97.8%	97.7%	98.0%	
	Predicted Separator Water / Measured Separator Water	0.0291	95.1%	95.0%	96.1%		95.1%	95.0%	96.1%	
Mass Bal.	Volume of Dead Oil Required to match Mass Balance (Bbls.)		2.63	2.64	2.71		2.73	2.85	2.97	
			GPA 2103M				GPA 2186M			
			Summer MP4-4 CP				Summer MP4-4 CP			
		Measured	Sim 1	Sim 2	Sim 3	Sim 4	Sim 1	Sim 2	Sim 3	Sim 4
FGOR	Flash Gas to Oil Ratio (FGOR) - Scf/ST Bbl	321.7	315.0	315.1	314.1	258.3	308.4	304.6	309.8	265.6
	EOS Bubble Point at Tsep (psia)	241.3	225.8	231.6	222.4		226.3	233.1	223.6	
	bbl post flash liquids / bbl feed (inlet pressurized liquids)		0.8313	0.8314	0.8475		0.8359	0.8378	0.8514	
Sep. Bal.	Predicted Separator Gas / Measured Separator Gas	8821	100.5%	100.6%	100.5%		100.4%	100.4%	100.4%	
	Predicted Separator Oil / Measured Separator Oil	0.5786	95.2%	94.8%	95.9%		97.1%	97.0%	97.3%	
	Predicted Separator Water / Measured Separator Water	0.0291	95.1%	95.0%	96.1%		95.1%	95.0%	96.1%	
Mass Bal.	Volume of Dead Oil Required to match Mass Balance (Bbls.)		3.55	3.73	3.82		3.57	3.67	3.82	

Summer MP5-A										
			GPA 2103M				GPA 2186M			
			Summer MP5-1 CP				Summer MP5-1 CP			
		Measured	Sim 1	Sim 2	Sim 3	Sim 4	Sim 1	Sim 2	Sim 3	Sim 4
FGOR	Flash Gas to Oil Ratio (FGOR) - Scf/ST Bbl	322.6	321.3	321.7	320.3	271.8	307.8	297.5	310.1	262.8
	EOS Bubble Point at Tsep (psia)	242.9	222.1	240.1	230.6		219.0	231.0	227.8	
	bbl post flash liquids / bbl feed (inlet pressurized liquids)		0.8276	0.8275	0.8438		0.8351	0.8398	0.8502	
Sep. Bal.	Predicted Separator Gas / Measured Separator Gas	7625	100.6%	100.6%	100.5%		100.4%	100.7%	100.4%	
	Predicted Separator Oil / Measured Separator Oil	0.4825	95.2%	94.8%	96.0%		97.9%	93.3%	98.2%	
	Predicted Separator Water / Measured Separator Water	0.0243	92.8%	92.8%	90.5%		92.8%	92.7%	90.5%	
Mass Bal.	Volume of Dead Oil Required to match Mass Balance (Bbls.)		1.23	1.31	1.34		1.00	1.04	1.24	
			GPA 2103M				GPA 2186M			
			Summer MP5-2 CV				Summer MP5-2 CV			
		Measured	Sim 1	Sim 2	Sim 3	Sim 4	Sim 1	Sim 2	Sim 3	Sim 4
FGOR	Flash Gas to Oil Ratio (FGOR) - Scf/ST Bbl	322.6	297.0	297.4	294.4	258.4	300.1	297.4	302.2	257.9
	EOS Bubble Point at Tsep (psia)	242.9	205.3	220.3	212.0		213.6	231.5	222.2	
	bbl post flash liquids / bbl feed (inlet pressurized liquids)		0.8385	0.8384	0.8542		0.8384	0.8399	0.8532	
Sep. Bal.	Predicted Separator Gas / Measured Separator Gas	7625	100.4%	100.5%	100.4%		100.3%	100.4%	100.3%	
	Predicted Separator Oil / Measured Separator Oil	0.4825	96.5%	96.2%	97.4%		98.2%	98.1%	98.5%	
	Predicted Separator Water / Measured Separator Water	0.0243	92.8%	92.8%	90.5%		92.9%	92.8%	90.5%	
Mass Bal.	Volume of Dead Oil Required to match Mass Balance (Bbls.)		0.93	0.99	0.99		1.02	1.04	1.11	

Summer MP5-B										
			GPA 2103M				GPA 2186M			
			Summer MP5-3 CV				Summer MP5-3 CV			
		Measured	Sim 1	Sim 2	Sim 3	Sim 4	Sim 1	Sim 2	Sim 3	Sim 4
FGOR	Flash Gas to Oil Ratio (FGOR) - Scf/ST Bbl	322.6	306.8	307.4	305.1	264.9	300.1	297.6	302.3	257.8
	EOS Bubble Point at Tsep (psia)	242.9	209.6	225.2	216.9		211.0	230.3	219.7	
	bbl post flash liquids / bbl feed (inlet pressurized liquids)		0.8338	0.8336	0.8494		0.8383	0.8397	0.8531	
Sep. Bal.	Predicted Separator Gas / Measured Separator Gas	7625	100.5%	100.5%	100.4%		100.3%	100.7%	100.3%	
	Predicted Separator Oil / Measured Separator Oil	0.4825	95.9%	95.5%	96.8%		98.1%	93.3%	98.4%	
	Predicted Separator Water / Measured Separator Water	0.0243	92.8%	92.8%	90.5%		92.9%	92.7%	91.7%	
Mass Bal.	Volume of Dead Oil Required to match Mass Balance (Bbls.)		1.03	1.09	1.11		1.00	1.04	1.10	
			GPA 2103M				GPA 2186M			
			Summer MP5-4 CP				Summer MP5-4 CP			
		Measured	Sim 1	Sim 2	Sim 3	Sim 4	Sim 1	Sim 2	Sim 3	Sim 4
FGOR	Flash Gas to Oil Ratio (FGOR) - Scf/ST Bbl	322.6	322.1	322.6	319.9	276.7	395.9	386.3	397.8	337.0
	EOS Bubble Point at Tsep (psia)	242.9	222.6	238.7	229.8		241.4	260.6	250.3	
	bbl post flash liquids / bbl feed (inlet pressurized liquids)		0.8274	0.8273	0.8436		0.7932	0.7987	0.8106	
Sep. Bal.	Predicted Separator Gas / Measured Separator Gas	7625	100.5%	100.6%	100.5%		100.8%	100.8%	100.8%	
	Predicted Separator Oil / Measured Separator Oil	0.4825	95.4%	95.1%	96.4%		93.2%	93.1%	93.9%	
	Predicted Separator Water / Measured Separator Water	0.0243	92.8%	92.8%	90.5%		92.8%	92.7%	90.5%	
Mass Bal.	Volume of Dead Oil Required to match Mass Balance (Bbls.)		1.30	1.37	1.39		2.17	2.10	2.41	

Summer LP1										
			GPA 2103M				GPA 2186M			
			Summer LP1-1 CV				Summer LP1-1 CV			
		Measured	Sim 1	Sim 2	Sim 3	Sim 4	Sim 1	Sim 2	Sim 3	Sim 4
FGOR	Flash Gas to Oil Ratio (FGOR) - Scf/ST Bbl	304.0	247.7	248.0	245.6	228.2	233.8	231.8	235.5	213.5
	EOS Bubble Point at Tsep (psia)	190.0	158.9	165.0	159.2		154.5	161.2	155.2	
	bbl post flash liquids / bbl feed (inlet pressurized liquids)		0.8596	0.8596	0.8734		0.8674	0.8686	0.8797	
Sep. Bal.	Predicted Separator Gas / Measured Separator Gas	8078	100.5%	100.6%	100.7%		100.3%	100.3%	100.3%	
	Predicted Separator Oil / Measured Separator Oil	0.4780	95.1%	94.9%	93.5%		98.4%	98.4%	99.0%	
	Predicted Separator Water / Measured Separator Water	0.0240	92.0%	91.7%	87.5%		92.0%	91.7%	91.7%	
Mass Bal.	Volume of Dead Oil Required to match Mass Balance (Bbls.)		1.30	1.37	1.39		1.15	1.18	1.24	
			GPA 2103M				GPA 2186M			
			Summer LP1-2 CP				Summer LP1-2 CP			
		Measured	Sim 1	Sim 2	Sim 3	Sim 4	Sim 1	Sim 2	Sim 3	Sim 4
FGOR	Flash Gas to Oil Ratio (FGOR) - Scf/ST Bbl	304.0	273.3	273.7	272.0	243.0	260.1	257.8	261.7	213.5
	EOS Bubble Point at Tsep (psia)	190.0	182.2	189.1	182.3		179.1	187.0	179.8	
	bbl post flash liquids / bbl feed (inlet pressurized liquids)		0.8480	0.8479	0.8623		0.8557	0.8570	0.8687	
Sep. Bal.	Predicted Separator Gas / Measured Separator Gas	8078	100.6%	100.7%	100.6%		100.4%	100.4%	100.4%	
	Predicted Separator Oil / Measured Separator Oil	0.4780	94.3%	94.0%	95.6%		97.5%	97.5%	98.1%	
	Predicted Separator Water / Measured Separator Water	0.0240	92.0%	91.7%	91.7%		92.0%	91.7%	91.7%	
Mass Bal.	Volume of Dead Oil Required to match Mass Balance (Bbls.)		1.81	1.90	1.94		1.70	1.75	1.83	
			GPA 2103M				GPA 2186M			
			Summer LP1-3 CP				Summer LP1-3 CP			
		Measured	Sim 1	Sim 2	Sim 3	Sim 4	Sim 1	Sim 2	Sim 3	Sim 4
FGOR	Flash Gas to Oil Ratio (FGOR) - Scf/ST Bbl	304.0	276.8	271.7	275.9	240.2	264.1	261.0	265.7	233.3
	EOS Bubble Point at Tsep (psia)	190.0	191.4	199.1	191.3		185.9	194.2	186.5	
	bbl post flash liquids / bbl feed (inlet pressurized liquids)		0.8463	0.8490	0.8611		0.8542	0.8556	0.8673	
Sep. Bal.	Predicted Separator Gas / Measured Separator Gas	8078	100.6%	100.7%	100.6%		100.4%	100.4%	100.4%	
	Predicted Separator Oil / Measured Separator Oil	0.4780	94.1%	93.9%	95.6%		97.4%	97.4%	98.1%	
	Predicted Separator Water / Measured Separator Water	0.0240	91.9%	91.7%	91.7%		92.0%	91.7%	91.7%	
Mass Bal.	Volume of Dead Oil Required to match Mass Balance (Bbls.)		1.94	1.88	2.10		1.83	1.76	1.98	

Summer LP2										
			GPA 2103M				GPA 2186M			
			Summer LP2-1 CP				Summer LP2-1 CP			
		Measured	Sim 1	Sim 2	Sim 3	Sim 4	Sim 1	Sim 2	Sim 3	Sim 4
FGOR	Flash Gas to Oil Ratio (FGOR) - Scf/ST Bbl	259.1	243.6	246.5	242.8	213.8	244.3	242.6	246.0	181.5
	EOS Bubble Point at Tsep (psia)	187.6	173.1	194.2	176.1		175.2	187.3	178.4	
	bbl post flash liquids / bbl feed (inlet pressurized liquids)		0.8625	0.8610	0.8761		0.8636	0.8647	0.8764	
Sep. Bal.	Predicted Separator Gas / Measured Separator Gas	7211	100.9%	101.0%	100.9%		100.7%	100.7%	100.7%	
	Predicted Separator Oil / Measured Separator Oil	0.5541	92.7%	92.4%	93.5%		94.9%	94.9%	95.3%	
	Predicted Separator Water / Measured Separator Water	0.0279	93.1%	92.9%	93.2%		93.1%	92.9%	93.4%	
Mass Bal.	Volume of Dead Oil Required to match Mass Balance (Bbls.)		0.70	0.47	0.75		0.79	0.68	0.86	
			GPA 2103M				GPA 2186M			
			Summer LP2-2 CV				Summer LP2-2 CV			
		Measured	Sim 1	Sim 2	Sim 3	Sim 4	Sim 1	Sim 2	Sim 3	Sim 4
FGOR	Flash Gas to Oil Ratio (FGOR) - Scf/ST Bbl	259.1	234.5	235.3	234.1	208.2	228.3	226.3	230.3	203.2
	EOS Bubble Point at Tsep (psia)	187.6	161.3	167.6	161.5		159.5	165.8	159.8	
	bbl post flash liquids / bbl feed (inlet pressurized liquids)		0.8661	0.8657	0.8791		0.8704	0.8716	0.8824	
Sep. Bal.	Predicted Separator Gas / Measured Separator Gas	7211	100.9%	100.9%	100.8%		100.7%	100.7%	100.7%	
	Predicted Separator Oil / Measured Separator Oil	0.5541	92.7%	92.4%	93.5%		95.2%	95.2%	95.5%	
	Predicted Separator Water / Measured Separator Water	0.0279	93.1%	92.9%	93.4%		93.1%	92.9%	93.4%	
Mass Bal.	Volume of Dead Oil Required to match Mass Balance (Bbls.)		0.54	0.48	0.57		0.50	0.43	0.56	
			GPA 2103M				GPA 2186M			
			Summer LP2-3 CV				Summer LP2-3 CV			
		Measured	Sim 1	Sim 2	Sim 3	Sim 4	Sim 1	Sim 2	Sim 3	Sim 4
FGOR	Flash Gas to Oil Ratio (FGOR) - Scf/ST Bbl	259.1	261.2	254.5	258.4	222.6	229.6	227.9	231.5	203.5
	EOS Bubble Point at Tsep (psia)	187.6	203.7	211.3	203.0		162.2	170.1	162.5	
	bbl post flash liquids / bbl feed (inlet pressurized liquids)		0.8512	0.8574	0.8694		0.8700	0.8711	0.8822	
Sep. Bal.	Predicted Separator Gas / Measured Separator Gas	7211	101.0%	101.1%	101.0%		100.7%	100.7%	100.7%	
	Predicted Separator Oil / Measured Separator Oil	0.5541	91.9%	91.6%	92.9%		95.3%	95.2%	95.6%	
	Predicted Separator Water / Measured Separator Water	0.0279	93.1%	92.9%	93.2%		93.1%	92.9%	93.4%	
Mass Bal.	Volume of Dead Oil Required to match Mass Balance (Bbls.)		1.00	0.76	1.04		0.54	0.46	0.59	

Summer LP3										
		GPA 2103M					GPA 2186M			
		Summer LP3-1 CV					Summer LP3-1 CV			
		Measured	Sim 1	Sim 2	Sim 3	Sim 4	Sim 1	Sim 2	Sim 3	Sim 4
FGOR	Flash Gas to Oil Ratio (FGOR) - Scf/ST Bbl	228.1	233.0	233.6	233.0	203.7	225.7	224.0	227.2	164.8
	EOS Bubble Point at Tsep (psia)	190.2	174.1	183.5	176.3		170.9	182.7	173.2	
	bbl post flash liquids / bbl feed (inlet pressurized liquids)		0.8672	0.8670	0.8799		0.8720	0.8730	0.8841	
Sep. Bal.	Predicted Separator Gas / Measured Separator Gas	7237	101.1%	101.2%	101.1%		100.9%	100.9%	100.9%	
	Predicted Separator Oil / Measured Separator Oil	0.4489	89.1%	88.8%	90.2%		92.3%	92.3%	93.1%	
	Predicted Separator Water / Measured Separator Water	0.0226	88.0%	87.5%	88.5%		88.1%	87.5%	89.6%	
Mass Bal.	Volume of Dead Oil Required to match Mass Balance (Bbls.)									
		GPA 2103M					GPA 2186M			
		Summer LP3-2 CP					Summer LP3-2 CP			
		Measured	Sim 1	Sim 2	Sim 3	Sim 4	Sim 1	Sim 2	Sim 3	Sim 4
FGOR	Flash Gas to Oil Ratio (FGOR) - Scf/ST Bbl	228.1	245.0	242.4	244.1	209.1	232.0	228.6	233.4	200.2
	EOS Bubble Point at Tsep (psia)	190.2	184.4	194.5	186.7		182.0	192.3	184.1	
	bbl post flash liquids / bbl feed (inlet pressurized liquids)		0.8613	0.8625	0.8749		0.8694	0.8712	0.8818	
Sep. Bal.	Predicted Separator Gas / Measured Separator Gas	7237	101.2%	101.3%	101.2%		100.9%	100.9%	100.9%	
	Predicted Separator Oil / Measured Separator Oil	0.4489	88.0%	87.7%	89.3%		92.3%	92.2%	93.1%	
	Predicted Separator Water / Measured Separator Water	0.0226	88.0%	87.5%	88.5%		88.1%	87.5%	87.5%	
Mass Bal.	Volume of Dead Oil Required to match Mass Balance (Bbls.)									
		GPA 2103M					GPA 2186M			
		Summer LP3-3 CP					Summer LP3-3 CP			
		Measured	Sim 1	Sim 2	Sim 3	Sim 4	Sim 1	Sim 2	Sim 3	Sim 4
FGOR	Flash Gas to Oil Ratio (FGOR) - Scf/ST Bbl	228.1	242.0	242.6	240.9	208.0	234.9	230.7	234.5	203.9
	EOS Bubble Point at Tsep (psia)	190.2	178.8	188.5	181.1		179.6	183.5	182.0	
	bbl post flash liquids / bbl feed (inlet pressurized liquids)		0.8625	0.8623	0.8760		0.8675	0.8700	0.8811	
Sep. Bal.	Predicted Separator Gas / Measured Separator Gas	7237	101.2%	101.3%	101.2%		100.9%	100.9%	100.9%	
	Predicted Separator Oil / Measured Separator Oil	0.4489	87.9%	87.7%	89.3%		92.2%	92.2%	92.9%	
	Predicted Separator Water / Measured Separator Water	0.0226	88.0%	87.5%	88.5%		88.1%	87.5%	88.5%	
Mass Bal.	Volume of Dead Oil Required to match Mass Balance (Bbls.)									

Appendix V.4 – Sensitivity (Numerical Approximation Method) Study Results

Winter Phase EOS Sensitivity Study HP4 GPA 2103M					
Tank Headspace temperature					
	Value	Units	FGOR	Shrinkage	B. Pt.
1 Minimum - Uncertainty (°F)	64.29	°F	339.543	0.8266	259.57
2 (Average + Minimum - Uncertainty)/2	67.25	°F	340.367	0.8261	259.57
3 Average (°F)	70.20	°F	341.207	0.8257	259.57
4 (Average + Maximum + Uncertainty)/2	73.25	°F	342.094	0.8252	259.57
5 Maximum + Uncertainty (°F)	76.31	°F	343.003	0.8247	259.57
Tank Headspace pressure					
	Value	Units	FGOR	Shrinkage	B. Pt.
6 Minimum -Uncertainty (PIT 2/16 + Pambient) (psi)	12.37	psia	341.424	0.8256	259.57
7 (Average + Minimum - Uncertainty)/2	12.46	psia	341.315	0.8256	259.57
8 Average (PIT 2/16 + Pambient) (psi)	12.55	psia	341.207	0.8257	259.57
9 (Average + Maximum + Uncertainty)/2	12.64	psia	341.100	0.8257	259.57
10 Maximum + Uncertainty (PIT 2/16 + Pambient) (psi)	12.73	psia	340.994	0.8258	259.57
Tank 1' from Bottom temperature					
	Value	Units	FGOR	Shrinkage	B. Pt.
11 Average -Uncertainty (°F)	43.3	°F	334.564	0.829	259.57
12 Average -1/2 Uncertainty (°F)	44.3	°F	337.864	0.8274	259.57
13 Average	45.3	°F	341.207	0.8257	259.57
14 Average + 1/2 Uncertainty (°F)	46.5	°F	345.274	0.8236	259.57
15 Average + Uncertainty (°F)	47.7	°F	349.402	0.8216	259.57
Tank 1' from Bottom pressure					
	Value	Units	FGOR	Shrinkage	B. Pt.
16 Minimum -Uncertainty (psi)	15.51	psia	344.708	0.824	259.57
17 (Average + Minimum - Uncertainty)/2	15.66	psia	342.945	0.8248	259.57
18 Average (Pamb + PIT2 + L*ρ*Constant) (psi)	15.81	psia	341.207	0.8257	259.57
19 (Average + Maximum + Uncertainty)/2	15.95	psia	339.606	0.8265	259.57
20 Maximum + Uncertainty (PIT 2/16 + Pambient) (psi)	16.10	psia	337.915	0.8273	259.57
Decanes Plus Molecular Weight					
	Value	Units	FGOR	Shrinkage	B. Pt.
21 Minimum - U	213.613	gm/gm-mol	342.942	0.8250	259.95
22 (Average + Minimum - U)/2	215.484	gm/gm-mol	342.379	0.8252	259.83
23 Average	217.356	gm/gm-mol	341.818	0.8254	259.70
24 (Average + Maximum + U)/2	219.227	gm/gm-mol	341.259	0.8257	259.58
25 Maximum + U	221.098	gm/gm-mol	340.703	0.8259	259.45
Decanes Plus Density					
	Value	Units	FGOR	Shrinkage	B. Pt.
26 Minimum - U	0.8174	(H ₂ O=1)	340.368	0.8260	258.48
27 (Average + Minimum - U)/2	0.8204	(H ₂ O=1)	340.681	0.8259	258.88
28 Average	0.8235	(H ₂ O=1)	341.007	0.8258	259.30
29 (Average + Maximum + U)/2	0.8265	(H ₂ O=1)	341.323	0.8256	259.72
30 Maximum + U	0.8295	(H ₂ O=1)	341.641	0.8255	260.14

EOS Sensitivity Study - Winter Phase - High Pressure #4 - GPA 2103M

Psep (psia)	Value	Units	FGOR	Shrinkage B. Pt.	
31	255.6	psia	338	0.8262	259.6
32	250.6	psia	333	0.8269	259.6
33	245.6	psia	329	0.8277	259.6
34	240.6	psia	325	0.8284	259.6
35	235.6	psia	320	0.8291	259.6

Tsep (°F)	Value	Units	FGOR	Shrinkage B. Pt.	
36	70.3	°F	341	0.8258	259.6
37	72.3	°F	338	0.8262	259.6
38	74.3	°F	336	0.8265	259.6
39	76.3	°F	334	0.8269	259.6
40	78.3	°F	331	0.8273	259.6

Siphon Prevention Hole	Value	Units	FGOR	Shrinkage B. Pt.	
41	0.00	(0-1)	332	0.8305	259.6
42	0.03	(0-1)	337	0.8281	259.6
43	0.06	(0-1)	341	0.8257	259.6
44	0.12	(0-1)	351	0.8209	259.6
45	0.24	(0-1)	370	0.8112	259.6
46	0.48	(0-1)	409	0.7919	259.6
47	1.00	(0-1)	502	0.7500	259.6

Winter Phase EOS Sensitivity Study HP4 GPA 2186M					
Tank Headspace temperature					
	Values	Units	FGOR	Shrinkage	B. Pt.
1	64.29	°F	333.098	0.8308	268.65
2	67.25	°F	333.740	0.8304	268.65
3	70.20	°F	334.384	0.8301	268.65
4	73.25	°F	335.053	0.8297	268.65
5	76.31	°F	335.726	0.8294	268.65
Tank Headspace pressure					
	Values	Units	FGOR	Shrinkage	B. Pt.
6	12.37	psia	334.557	0.8300	268.65
7	12.46	psia	334.470	0.8300	268.65
8	12.55	psia	334.384	0.8301	268.65
9	12.64	psia	334.298	0.8301	268.65
10	12.73	psia	334.214	0.8302	268.65
Tank 1' from Bottom temperature					
	Values	Units	FGOR	Shrinkage	B. Pt.
11	43.3	°F	328.494	0.8331	268.65
12	44.3	°F	331.426	0.8316	268.65
13	45.3	°F	334.384	0.8301	268.65
14	46.5	°F	337.969	0.8283	268.65
15	47.7	°F	341.593	0.8265	268.65
Tank 1' from Bottom pressure					
	Values	Units	FGOR	Shrinkage	B. Pt.
16	15.51	psia	337.552	0.8285	268.65
17	15.66	psia	335.958	0.8293	268.65
18	15.81	psia	334.384	0.8301	268.65
19	15.95	psia	332.933	0.8308	268.65
20	16.10	psia	331.398	0.8316	268.65
Decanes Plus Molecular Weight					
	Values	Units	FGOR	Shrinkage	B. Pt.
21	146.231	gm/gm-mol	337.209	0.8289	268.92
22	147.220	gm/gm-mol	336.204	0.8293	268.82
23	148.210	gm/gm-mol	335.205	0.8297	268.73
24	149.199	gm/gm-mol	334.215	0.8302	268.63
25	150.188	gm/gm-mol	333.233	0.8306	268.53
Decanes Plus Density					
	Values	Units	FGOR	Shrinkage	B. Pt.
26	0.7509	(H ₂ O=1)	333.527	0.8305	268.08
27	0.7534	(H ₂ O=1)	334.088	0.8302	268.45
28	0.7560	(H ₂ O=1)	334.676	0.8300	268.85
29	0.7585	(H ₂ O=1)	335.245	0.8297	269.27
30	0.7610	(H ₂ O=1)	335.818	0.8295	269.71

EOS Sensitivity Study - Winter Phase - High Pressure #4 - GPA 2186M					
Psep (psia)	Value	Units	FGOR	Shrinkage B. Pt.	
31	267.6	psia	334	0.8302	268.7
32	262.6	psia	329	0.8308	268.7
33	257.6	psia	325	0.8315	268.7
34	252.6	psia	321	0.8321	268.7
35	247.6	psia	317	0.8328	268.7
Tsep (°F)	Value	Units	FGOR	Shrinkage B. Pt.	
36	63.3	°F	334	0.8301	268.7
37	65.3	°F	332	0.8305	268.7
38	67.3	°F	330	0.8308	268.7
39	69.3	°F	327	0.8312	268.7
40	71.3	°F	325	0.8315	268.7
Siphon Prevention Hole	Value	Units	FGOR	Shrinkage B. Pt.	
41	0.00	(0-1)	327	0.8341	268.7
42	0.03	(0-1)	331	0.8321	268.7
43	0.06	(0-1)	334	0.8301	268.7
44	0.12	(0-1)	342	0.8261	268.7
45	0.24	(0-1)	358	0.8181	268.7
46	0.48	(0-1)	391	0.8021	268.7
47	1.00	(0-1)	466	0.7674	268.7

Winter Phase EOS Sensitivity Study MP2 GPA 2103M					
Tank Headspace temperature					
	Value	Units	FGOR	Shrinkage	B. Pt.
1 Minimum - Uncertainty (°F)	70.9	°F	201.707	0.8887	197.63
2 (Average + Minimum - Uncertainty)/2	72.3	°F	201.976	0.8885	197.63
3 Average (°F)	73.7	°F	202.248	0.8883	197.63
4 (Average + Maximum + Uncertainty)/2	75.3	°F	202.564	0.8881	197.63
5 Maximum + Uncertainty (°F)	76.9	°F	202.884	0.8879	197.63
Tank Headspace pressure					
	Value	Units	FGOR	Shrinkage	B. Pt.
6 Minimum -Uncertainty (PIT 2/16 + Pambient) (psi)	12.38	psia	202.403	0.8882	197.63
7 (Average + Minimum - Uncertainty)/2	12.47	psia	202.325	0.8883	197.63
8 Average (PIT 2/16 + Pambient) (psi)	12.55	psia	202.257	0.8883	197.63
9 (Average + Maximum + Uncertainty)/2	12.63	psia	202.189	0.8884	197.63
10 Maximum + Uncertainty (PIT 2/16 + Pambient) (psi)	12.72	psia	202.113	0.8884	197.63
Tank 1' from Bottom temperature					
	Value	Units	FGOR	Shrinkage	B. Pt.
11 Average -Uncertainty (°F)	43.9	°F	202.042	0.8885	197.63
12 Average -1/2 Uncertainty (°F)	44.7	°F	203.705	0.8875	197.63
13 Average	45.4	°F	205.174	0.8866	197.63
14 Average + 1/2 Uncertainty (°F)	46.2	°F	206.870	0.8857	197.63
15 Average + Uncertainty (°F)	46.9	°F	208.368	0.8848	197.63
Tank 1' from Bottom pressure					
	Value	Units	FGOR	Shrinkage	B. Pt.
16 Minimum -Uncertainty (psi)	15.68	psia	201.349	0.8888	197.63
17 (Average + Minimum - Uncertainty)/2	15.76	psia	200.755	0.8892	197.63
18 Average (Pamb + PIT2 + L*ρ*Constant) (psi)	15.85	psia	200.092	0.8896	197.63
19 (Average + Maximum + Uncertainty)/2	15.93	psia	199.507	0.8899	197.63
20 Maximum + Uncertainty (PIT 2/16 + Pambient) (psi)	16.01	psia	198.927	0.8902	197.63
Decanes Plus Molecular Weight					
	Value	Units	FGOR	Shrinkage	B. Pt.
21 Minimum - U	208.872	gm/gm-mol	204.062	0.8873	198.35
22 (Average + Minimum - U)/2	211.973	gm/gm-mol	203.448	0.8876	198.11
23 Average	215.073	gm/gm-mol	202.845	0.888	197.87
24 (Average + Maximum + U)/2	217.455	gm/gm-mol	202.388	0.8882	197.69
25 Maximum + U	219.838	gm/gm-mol	201.937	0.8885	197.49
Decanes Plus Density					
	Value	Units	FGOR	Shrinkage	B. Pt.
26 Minimum - U	0.8162	(H ₂ O=1)	202.378	0.8885	196.73
27 (Average + Minimum - U)/2	0.8190	(H ₂ O=1)	202.322	0.8884	197.13
28 Average	0.8219	(H ₂ O=1)	202.259	0.8883	197.55
29 (Average + Maximum + U)/2	0.8243	(H ₂ O=1)	202.206	0.8883	197.91
30 Maximum + U	0.8268	(H ₂ O=1)	202.148	0.8882	198.29

EOS Sensitivity Study - Winter Phase - Medium Pressure #2 - GPA 2103M					
Psep (psia)	Value	Units	FGOR	Shrinkage B. Pt.	
31	234.5	psia	207	0.8875	234.6
32	229.5	psia	204	0.8881	234.6
33	224.5	psia	200	0.8887	234.6
34	219.5	psia	197	0.8893	234.6
35	214.5	psia	194	0.8899	234.6
Tsep (°F)	Value	Units	FGOR	Shrinkage B. Pt.	
36	97.3	°F	207	0.8875	234.6
37	99.3	°F	205	0.8878	234.6
38	101.3	°F	204	0.8881	234.6
39	103.3	°F	202	0.8883	234.6
40	105.3	°F	201	0.8886	234.6
Siphon Prevention Hole	Value	Units	FGOR	Shrinkage B. Pt.	
41	0.00	(0-1)	198	0.8929	234.6
42	0.03	(0-1)	202	0.8908	234.6
43	0.06	(0-1)	205	0.8887	234.6
44	0.12	(0-1)	212	0.8845	234.6
45	0.24	(0-1)	226	0.8761	234.6
46	0.48	(0-1)	255	0.8594	234.6
47	1.00	(0-1)	323	0.8232	234.6

Winter Phase EOS Sensitivity Study MP2 GPA 2186M					
Tank Headspace temperature					
	Value	Units	FGOR	Shrinkage	B. Pt.
1 Minimum - Uncertainty (°F)	70.9	°F	198.255	0.8908	200.12
2 (Average + Minimum - Uncertainty)/2	72.3	°F	198.476	0.8907	200.12
3 Average (°F)	73.7	°F	198.699	0.8906	200.12
4 (Average + Maximum + Uncertainty)/2	75.3	°F	198.955	0.8904	200.12
5 Maximum + Uncertainty (°F)	76.9	°F	199.212	0.8903	200.12
Tank Headspace pressure					
	Value	Units	FGOR	Shrinkage	B. Pt.
6 Minimum -Uncertainty (PIT 2/16 + Pambient) (psi)	12.38	psia	198.830	0.8905	200.12
7 (Average + Minimum - Uncertainty)/2	12.47	psia	198.764	0.8905	200.12
8 Average (PIT 2/16 + Pambient) (psi)	12.55	psia	198.699	0.8906	200.12
9 (Average + Maximum + Uncertainty)/2	12.63	psia	198.648	0.8906	200.12
10 Maximum + Uncertainty (PIT 2/16 + Pambient) (psi)	12.72	psia	198.584	0.8906	200.12
Tank 1' from Bottom temperature					
	Value	Units	FGOR	Shrinkage	B. Pt.
11 Average -Uncertainty (°F)	43.9	°F	198.509	0.8907	200.12
12 Average -1/2 Uncertainty (°F)	44.7	°F	200.034	0.8898	200.12
13 Average	45.4	°F	201.379	0.8890	200.12
14 Average + 1/2 Uncertainty (°F)	46.2	°F	202.929	0.8881	200.12
15 Average + Uncertainty (°F)	46.9	°F	204.296	0.8873	200.12
Tank 1' from Bottom pressure					
	Value	Units	FGOR	Shrinkage	B. Pt.
16 Minimum -Uncertainty (psi)	15.68	psia	197.853	0.8911	200.12
17 (Average + Minimum - Uncertainty)/2	15.76	psia	197.295	0.8914	200.12
18 Average (Pamb + PIT2 + L*p*Constant) (psi)	15.85	psia	196.671	0.8917	200.12
19 (Average + Maximum + Uncertainty)/2	15.93	psia	196.121	0.892	200.12
20 Maximum + Uncertainty (PIT 2/16 + Pambient) (psi)	16.01	psia	195.575	0.8923	200.12
Decanes Plus Molecular Weight					
	Value	Units	FGOR	Shrinkage	B. Pt.
21 Minimum - U	145.990	gm/gm-mol	199.352	0.8902	200.23
22 (Average + Minimum - U)/2	146.574	gm/gm-mol	199.031	0.8904	200.18
23 Average	147.158	gm/gm-mol	198.699	0.8906	200.12
24 (Average + Maximum + U)/2	147.742	gm/gm-mol	198.392	0.8907	200.06
25 Maximum + U	148.326	gm/gm-mol	198.075	0.8909	200.01
Decanes Plus Density					
	Value	Units	FGOR	Shrinkage	B. Pt.
26 Minimum - U	0.7535	(H ₂ O=1)	198.534	0.8908	199.61
27 (Average + Minimum - U)/2	0.7554	(H ₂ O=1)	198.617	0.8907	199.85
28 Average	0.7574	(H ₂ O=1)	198.699	0.8906	200.12
29 (Average + Maximum + U)/2	0.7593	(H ₂ O=1)	198.770	0.8905	200.38
30 Maximum + U	0.7612	(H ₂ O=1)	198.835	0.8904	200.66

EOS Sensitivity Study - Winter Phase - Medium Pressure #2 - GPA 2186M					
Psep (psia)	Value	Units	FGOR	Shrinkage B. Pt.	
21	236.5	psia	205	0.8895	237.3
32	231.5	psia	202	0.8901	237.3
33	226.5	psia	198	0.8907	237.3
34	221.5	psia	195	0.8912	237.3
35	216.5	psia	191	0.8918	237.3
Tsep (°F)	Value	Units	FGOR	Shrinkage B. Pt.	
36	94.3	°F	205	0.8895	237.3
37	96.3	°F	204	0.8897	237.3
38	98.3	°F	202	0.8899	237.3
39	100.3	°F	201	0.8902	237.3
40	102.3	°F	199	0.8904	237.3
Siphon Prevention Hole	Value	Units	FGOR	Shrinkage B. Pt.	
41	0.00	(0-1)	197	0.8942	237.3
42	0.03	(0-1)	200	0.8924	237.3
43	0.06	(0-1)	203	0.8906	237.3
44	0.12	(0-1)	210	0.8870	237.3
45	0.24	(0-1)	222	0.8797	237.3
46	0.48	(0-1)	247	0.8652	237.3
47	1.00	(0-1)	306	0.8337	237.3

Winter Phase EOS Sensitivity Study LP1 GPA 2103M					
Tank Headspace temperature					
	Value	Units	FGOR	Shrinkage	B. Pt.
1 Minimum - Uncertainty (°F)	80.9	°F	150.288	0.9152	155.19
2 (Average + Minimum - Uncertainty)/2	83.2	°F	150.685	0.9149	155.19
3 Average (°F)	85.5	°F	151.091	0.9146	155.19
4 (Average + Maximum + Uncertainty)/2	87.5	°F	151.451	0.9144	155.19
5 Maximum + Uncertainty (°F)	89.6	°F	151.836	0.9141	155.19
Tank Headspace pressure					
	Value	Units	FGOR	Shrinkage	B. Pt.
6 Minimum -Uncertainty (PIT 2/16 + Pambient) (psi)	12.38	psia	151.191	0.9146	155.19
7 (Average + Minimum - Uncertainty)/2	12.47	psia	151.119	0.9146	155.19
8 Average (PIT 2/16 + Pambient) (psi)	12.55	psia	151.055	0.9147	155.19
9 (Average + Maximum + Uncertainty)/2	12.63	psia	150.992	0.9147	155.19
10 Maximum + Uncertainty (PIT 2/16 + Pambient) (psi)	12.72	psia	150.921	0.9147	155.19
Tank 1' from Bottom temperature					
	Value	Units	FGOR	Shrinkage	B. Pt.
11 Average -Uncertainty (°F)	44.6	°F	150.413	0.9150	155.19
12 Average -1/2 Uncertainty (°F)	45.4	°F	151.700	0.9143	155.19
13 Average	46.1	°F	152.838	0.9136	155.19
14 Average + 1/2 Uncertainty (°F)	46.9	°F	154.151	0.9128	155.19
15 Average + Uncertainty (°F)	47.6	°F	155.312	0.9121	155.19
Tank 1' from Bottom pressure					
	Value	Units	FGOR	Shrinkage	B. Pt.
16 Minimum -Uncertainty (psi)	15.72	psia	150.273	0.9151	155.19
17 (Average + Minimum - Uncertainty)/2	15.81	psia	149.738	0.9154	155.19
18 Average (Pamb + PIT2 + L*ρ*Constant) (psi)	15.89	psia	149.266	0.9157	155.19
19 (Average + Maximum + Uncertainty)/2	15.97	psia	148.797	0.916	155.19
20 Maximum + Uncertainty (PIT 2/16 + Pambient) (psi)	16.06	psia	148.274	0.9163	155.19
Decanes Plus Molecular Weight					
	Value	Units	FGOR	Shrinkage	B. Pt.
21 Minimum - U	212.582	gm/gm-mol	151.308	0.9145	155.31
22 (Average + Minimum - U)/2	214.899	gm/gm-mol	150.966	0.9147	155.15
23 Average	217.216	gm/gm-mol	150.628	0.9149	155.00
24 (Average + Maximum + U)/2	219.533	gm/gm-mol	150.294	0.9151	154.84
25 Maximum + U	221.850	gm/gm-mol	149.965	0.9153	154.69
Decanes Plus Density					
	Value	Units	FGOR	Shrinkage	B. Pt.
26 Minimum - U	0.8173	(H ₂ O=1)	151.112	0.9147	154.72
27 (Average + Minimum - U)/2	0.8199	(H ₂ O=1)	151.077	0.9147	155.02
28 Average	0.8225	(H ₂ O=1)	151.039	0.9146	155.32
29 (Average + Maximum + U)/2	0.8251	(H ₂ O=1)	151.000	0.9146	155.64
30 Maximum + U	0.8277	(H ₂ O=1)	150.959	0.9145	155.95

EOS Sensitivity Study - Winter Phase - Low Pressure #1 - GPA 2103M					
Psep (psia)	Value	Units	FGOR	Shrinkage B. Pt.	
31	180.6	psia	153	0.9144	180.7
32	175.6	psia	149	0.915	180.7
33	170.6	psia	146	0.9156	180.7
34	165.6	psia	143	0.9163	180.7
35	160.6	psia	139	0.9169	180.7
Tsep (°F)	Value	Units	FGOR	Shrinkage B. Pt.	
36	98.4	°F	152	0.9144	180.7
37	100.4	°F	151	0.9146	180.7
38	102.4	°F	150	0.9148	180.7
39	104.4	°F	149	0.9151	180.7
40	106.4	°F	148	0.9153	180.7
Siphon Prevention Hole	Value	Units	FGOR	Shrinkage B. Pt.	
41	0.00	(0-1)	144	0.9194	180.7
42	0.03	(0-1)	147	0.9170	180.7
43	0.06	(0-1)	151	0.9147	180.7
44	0.12	(0-1)	158	0.9100	180.7
45	0.24	(0-1)	173	0.9006	180.7
46	0.48	(0-1)	204	0.8818	180.7
47	1.00	(0-1)	275	0.8411	180.7

Winter Phase EOS Sensitivity Study LP1 GPA 2186M					
Tank Headspace temperature	Value	Units	FGOR	Shrinkage	B. Pt.
1 Minimum - Uncertainty (°F)	80.9	°F	147.312	0.9177	154.43
2 (Average + Minimum - Uncertainty)/2	83.2	°F	147.623	0.9175	154.43
3 Average (°F)	85.5	°F	147.936	0.9173	154.43
4 (Average + Maximum + Uncertainty)/2	87.5	°F	148.211	0.9171	154.43
5 Maximum + Uncertainty (°F)	89.6	°F	148.503	0.9169	154.43
Tank Headspace pressure	Value	Units	FGOR	Shrinkage	B. Pt.
6 Minimum -Uncertainty (PIT 2/16 + Pambient) (psi)	12.38	psia	148.019	0.9173	154.43
7 (Average + Minimum - Uncertainty)/2	12.47	psia	147.960	0.9173	154.43
8 Average (PIT 2/16 + Pambient) (psi)	12.55	psia	147.909	0.9173	154.43
9 (Average + Maximum + Uncertainty)/2	12.63	psia	147.857	0.9174	154.43
10 Maximum + Uncertainty (PIT 2/16 + Pambient) (psi)	12.72	psia	147.800	0.9174	154.43
Tank 1' from Bottom temperature	Value	Units	FGOR	Shrinkage	B. Pt.
11 Average -Uncertainty (°F)	44.6	°F	147.321	0.9177	154.43
12 Average -1/2 Uncertainty (°F)	45.4	°F	148.499	0.9170	154.43
13 Average	46.1	°F	149.538	0.9163	154.43
14 Average + 1/2 Uncertainty (°F)	46.9	°F	150.736	0.9156	154.43
15 Average + Uncertainty (°F)	47.6	°F	151.793	0.9150	154.43
Tank 1' from Bottom pressure	Value	Units	FGOR	Shrinkage	B. Pt.
16 Minimum -Uncertainty (psi)	15.72	psia	147.174	0.9178	154.43
17 (Average + Minimum - Uncertainty)/2	15.81	psia	146.671	0.9181	154.43
18 Average (Pamb + PIT2 + L*ρ*Constant) (psi)	15.89	psia	146.227	0.9183	154.43
19 (Average + Maximum + Uncertainty)/2	15.97	psia	145.786	0.9186	154.43
20 Maximum + Uncertainty (PIT 2/16 + Pambient) (psi)	16.06	psia	145.294	0.9189	154.43
Decanes Plus Molecular Weight	Value	Units	FGOR	Shrinkage	B. Pt.
21 Minimum - U	145.575	gm/gm-mol	148.531	0.9170	154.55
22 (Average + Minimum - U)/2	146.229	gm/gm-mol	148.252	0.9171	154.5
23 Average	146.883	gm/gm-mol	147.975	0.9173	154.45
24 (Average + Maximum + U)/2	147.536	gm/gm-mol	147.700	0.9174	154.39
25 Maximum + U	148.190	gm/gm-mol	147.425	0.9176	154.34
Decanes Plus Density	Value	Units	FGOR	Shrinkage	B. Pt.
26 Minimum - U	0.7537	(H ₂ O=1)	147.775	0.9175	154.03
27 (Average + Minimum - U)/2	0.7557	(H ₂ O=1)	147.847	0.9174	154.24
28 Average	0.7577	(H ₂ O=1)	147.915	0.9173	154.46
29 (Average + Maximum + U)/2	0.7596	(H ₂ O=1)	147.975	0.9172	154.67
30 Maximum + U	0.7616	(H ₂ O=1)	148.033	0.9171	154.91

EOS Sensitivity Study - Winter Phase - Low Pressure #1 - GPA 2186M					
Psep (psia)	Value	Units	FGOR	Shrinkage B. Pt.	
31	178.6	psia	149	0.9173	178.7
32	173.6	psia	145	0.9179	178.7
33	168.6	psia	142	0.9185	178.7
34	163.6	psia	139	0.9191	178.7
35	158.6	psia	135	0.9197	178.7
Tsep (°F)	Value	Units	FGOR	Shrinkage B. Pt.	
36	100.4	°F	149	0.9173	178.7
37	102.4	°F	147	0.9175	178.7
38	104.4	°F	146	0.9177	178.7
39	106.4	°F	145	0.9179	178.7
40	108.4	°F	144	0.9181	178.7
Siphon Prevention Hole	Value	Units	FGOR	Shrinkage B. Pt.	
41	0.00	(0-1)	142	0.9212	178.7
42	0.03	(0-1)	146	0.9192	178.7
43	0.06	(0-1)	149	0.9173	178.7
44	0.12	(0-1)	155	0.9133	178.7
45	0.24	(0-1)	168	0.9054	178.7
46	0.48	(0-1)	193	0.8896	178.7
47	1.00	(0-1)	253	0.8554	178.7

Summer Phase EOS Sensitivity Study HP3 GPA 2103M					
Tank Headspace temperature					
	Value	Units	FGOR	Shrinkage	B. Pt.
1 Minimum - Uncertainty (°F)	95.7	°F	376.748	0.8016	268.70
2 (Average + Minimum - Uncertainty)/2	97.7	°F	377.310	0.8013	268.70
3 Average (°F)	99.8	°F	377.909	0.8009	268.70
4 (Average + Maximum + Uncertainty)/2	102.2	°F	378.603	0.8006	268.70
5 Maximum + Uncertainty (°F)	104.6	°F	379.310	0.8002	268.70
Tank Headspace pressure					
	Value	Units	FGOR	Shrinkage	B. Pt.
6 Minimum -Uncertainty (PIT 2/16 + Pambient) (psi)	12.41	psia	378.256	0.8008	268.70
7 (Average + Minimum - Uncertainty)/2	12.50	psia	378.144	0.8008	268.70
8 Average (PIT 2/16 + Pambient) (psi)	12.58	psia	378.044	0.8009	268.70
9 (Average + Maximum + Uncertainty)/2	12.66	psia	377.945	0.8009	268.70
10 Maximum + Uncertainty (PIT 2/16 + Pambient) (psi)	12.75	psia	377.835	0.8010	268.70
Tank 1' from Bottom temperature					
	Value	Units	FGOR	Shrinkage	B. Pt.
11 Average -Uncertainty (°F)	81.4	°F	372.511	0.8037	268.70
12 Average -1/2 Uncertainty (°F)	82.2	°F	375.378	0.8022	268.70
13 Average	82.9	°F	377.909	0.8009	268.70
14 Average + 1/2 Uncertainty (°F)	83.7	°F	380.827	0.7995	268.70
15 Average + Uncertainty (°F)	84.4	°F	383.403	0.7982	268.70
Tank 1' from Bottom pressure					
	Value	Units	FGOR	Shrinkage	B. Pt.
16 Minimum -Uncertainty (psi)	16.40	psia	376.899	0.8014	268.70
17 (Average + Minimum - Uncertainty)/2	16.49	psia	375.771	0.8020	268.70
18 Average (Pamb + PIT2 + L*ρ*Constant) (psi)	16.57	psia	374.776	0.8025	268.70
19 (Average + Maximum + Uncertainty)/2	16.65	psia	373.788	0.8030	268.70
20 Maximum + Uncertainty (PIT 2/16 + Pambient) (psi)	16.74	psia	372.685	0.8035	268.70
Decanes Plus Molecular Weight					
	Value	Units	FGOR	Shrinkage	B. Pt.
21 Minimum - U	205.894	gm/gm-mol	378.574	0.8006	268.85
22 (Average + Minimum - U)/2	209.511	gm/gm-mol	377.133	0.8013	268.53
23 Average	213.129	gm/gm-mol	375.716	0.8020	268.20
24 (Average + Maximum + U)/2	216.469	gm/gm-mol	374.429	0.8026	267.89
25 Maximum + U	219.808	gm/gm-mol	373.164	0.8032	267.57
Decanes Plus Density					
	Value	Units	FGOR	Shrinkage	B. Pt.
26 Minimum - U	0.8162	(H ₂ O=1)	377.859	0.8011	267.99
27 (Average + Minimum - U)/2	0.8195	(H ₂ O=1)	377.899	0.8010	268.56
28 Average	0.8228	(H ₂ O=1)	377.936	0.8008	269.14
29 (Average + Maximum + U)/2	0.8266	(H ₂ O=1)	377.974	0.8007	269.83
30 Maximum + U	0.8304	(H ₂ O=1)	378.010	0.8005	270.52

EOS Sensitivity Study -Summer Phase -High Pressure #3 - GPA 2103M					
Psep (psia)	Value	Units	FGOR	Shrinkage B. Pt.	
31	277.4	psia	375	0.8024	281.1
32	272.4	psia	371	0.8031	281.1
33	267.4	psia	367	0.8037	281.1
34	262.4	psia	363	0.8044	281.1
35	257.4	psia	359	0.8051	281.1
Tsep (°F)	Value	Units	FGOR	Shrinkage B. Pt.	
36	83.8	°F	377	0.8021	281.1
37	85.8	°F	375	0.8024	281.1
38	87.8	°F	373	0.8028	281.1
39	89.8	°F	371	0.8031	281.1
40	91.8	°F	369	0.8034	281.1
Siphon Prevention Hole	Value	Units	FGOR	Shrinkage B. Pt.	
41	0.00	(0-1)	367	0.8067	281.1
42	0.03	(0-1)	371	0.8046	281.1
43	0.06	(0-1)	375	0.8024	281.1
44	0.12	(0-1)	383	0.7981	281.1
45	0.24	(0-1)	400	0.7896	281.1
46	0.48	(0-1)	435	0.7725	281.1
47	1.00	(0-1)	517	0.7354	281.1

Summer Phase EOS Sensitivity Study HP3 GPA 2186M					
Tank Headspace temperature					
	Value	Units	FGOR	Shrinkage	B. Pt.
1 Minimum - Uncertainty (°F)	95.7	°F	340.426	0.8197	249.99
2 (Average + Minimum - Uncertainty)/2	97.7	°F	340.836	0.8195	249.99
3 Average (°F)	99.8	°F	341.268	0.8192	249.99
4 (Average + Maximum + Uncertainty)/2	102.2	°F	341.765	0.8189	249.99
5 Maximum + Uncertainty (°F)	104.6	°F	342.266	0.8187	249.99
Tank Headspace pressure					
	Value	Units	FGOR	Shrinkage	B. Pt.
6 Minimum -Uncertainty (PIT 2/16 + Pambient) (psi)	12.41	psia	341.531	0.8191	249.99
7 (Average + Minimum - Uncertainty)/2	12.50	psia	341.445	0.8191	249.99
8 Average (PIT 2/16 + Pambient) (psi)	12.58	psia	341.370	0.8192	249.99
9 (Average + Maximum + Uncertainty)/2	12.66	psia	341.296	0.8192	249.99
10 Maximum + Uncertainty (PIT 2/16 + Pambient) (psi)	12.75	psia	341.212	0.8193	249.99
Tank 1' from Bottom temperature					
	Value	Units	FGOR	Shrinkage	B. Pt.
11 Average -Uncertainty (°F)	81.4	°F	336.936	0.8215	249.99
12 Average -1/2 Uncertainty (°F)	82.2	°F	339.240	0.8203	249.99
13 Average	82.9	°F	341.268	0.8192	249.99
14 Average + 1/2 Uncertainty (°F)	83.7	°F	343.599	0.818	249.99
15 Average + Uncertainty (°F)	84.4	°F	345.650	0.8169	249.99
Tank 1' from Bottom pressure					
	Value	Units	FGOR	Shrinkage	B. Pt.
16 Minimum -Uncertainty (psi)	16.40	psia	340.423	0.8197	249.99
17 (Average + Minimum - Uncertainty)/2	16.49	psia	339.479	0.8201	249.99
18 Average (Pamb + PIT2 + L*p*Constant) (psi)	16.57	psia	338.646	0.8206	249.99
19 (Average + Maximum + Uncertainty)/2	16.65	psia	337.817	0.8210	249.99
20 Maximum + Uncertainty (PIT 2/16 + Pambient) (psi)	16.74	psia	336.891	0.8214	249.99
Decanes Plus Molecular Weight					
	Value	Units	FGOR	Shrinkage	B. Pt.
21 Minimum - U	146.188	gm/gm-mol	342.402	0.8187	250.10
22 (Average + Minimum - U)/2	147.206	gm/gm-mol	341.403	0.8192	250.00
23 Average	148.223	gm/gm-mol	340.413	0.8196	249.91
24 (Average + Maximum + U)/2	149.046	gm/gm-mol	339.619	0.8199	249.83
25 Maximum + U	149.868	gm/gm-mol	338.832	0.8203	249.76
Decanes Plus Density					
	Value	Units	FGOR	Shrinkage	B. Pt.
26 Minimum - U	0.7501	(H ₂ O=1)	340.092	0.8197	249.27
27 (Average + Minimum - U)/2	0.7523	(H ₂ O=1)	340.561	0.8195	249.55
28 Average	0.7545	(H ₂ O=1)	341.032	0.8193	249.84
29 (Average + Maximum + U)/2	0.7570	(H ₂ O=1)	341.569	0.8191	250.19
30 Maximum + U	0.7595	(H ₂ O=1)	342.109	0.8188	250.56

EOS Sensitivity Study -Summer Phase -High Pressure #3 - GPA 2186M					
Psep (psia)	Value	Units	FGOR	Shrinkage B. Pt.	
21	257.4	psia	336	0.8211	261.7
32	252.4	psia	332	0.8217	261.7
33	247.4	psia	328	0.8223	261.7
34	242.4	psia	324	0.8229	261.7
35	237.4	psia	320	0.8236	261.7
Tsep (°F)	Value	Units	FGOR	Shrinkage B. Pt.	
36	101.8	°F	335	0.8211	261.7
37	103.8	°F	334	0.8213	261.7
38	105.8	°F	332	0.8216	261.7
39	107.8	°F	330	0.8219	261.7
40	109.8	°F	328	0.8222	261.7
Siphon Prevention Hole	Value	Units	FGOR	Shrinkage B. Pt.	
41	0.00	(0-1)	332	0.8239	261.7
42	0.03	(0-1)	335	0.8222	261.7
43	0.06	(0-1)	339	0.8205	261.7
44	0.12	(0-1)	345	0.8172	261.7
45	0.24	(0-1)	358	0.8104	261.7
46	0.48	(0-1)	384	0.7970	261.7
47	1.00	(0-1)	445	0.7678	261.7

Summer Phase EOS Sensitivity Study MP3 GPA 2103M					
Tank Headspace temperature					
	Value	Units	FGOR	Shrinkage	B. Pt.
1 Minimum - Uncertainty (°F)	86.6	°F	313.454	0.8300	228.34
2 (Average + Minimum - Uncertainty)/2	88.1	°F	313.805	0.8298	228.34
3 Average (°F)	89.6	°F	314.161	0.8296	228.34
4 (Average + Maximum + Uncertainty)/2	91.2	°F	314.545	0.8293	228.34
5 Maximum + Uncertainty (°F)	92.7	°F	314.909	0.8291	228.34
Tank Headspace pressure					
	Value	Units	FGOR	Shrinkage	B. Pt.
6 Minimum -Uncertainty (PIT 2/16 + Pambient) (psi)	12.38	psia	314.434	0.8294	228.34
7 (Average + Minimum - Uncertainty)/2	12.47	psia	314.338	0.8295	228.34
8 Average (PIT 2/16 + Pambient) (psi)	12.55	psia	314.255	0.8295	228.34
9 (Average + Maximum + Uncertainty)/2	12.63	psia	314.172	0.8296	228.34
10 Maximum + Uncertainty (PIT 2/16 + Pambient) (psi)	12.72	psia	314.079	0.8296	228.34
Tank 1' from Bottom temperature					
	Value	Units	FGOR	Shrinkage	B. Pt.
11 Average -Uncertainty (°F)	78.8	°F	309.525	0.8321	228.34
12 Average -1/2 Uncertainty (°F)	79.5	°F	311.678	0.8309	228.34
13 Average	80.3	°F	314.161	0.8296	228.34
14 Average + 1/2 Uncertainty (°F)	81.0	°F	316.353	0.8284	228.34
15 Average + Uncertainty (°F)	81.8	°F	318.881	0.8270	228.34
Tank 1' from Bottom pressure					
	Value	Units	FGOR	Shrinkage	B. Pt.
16 Minimum -Uncertainty (psi)	16.39	psia	313.391	0.8300	228.34
17 (Average + Minimum - Uncertainty)/2	16.47	psia	312.517	0.8304	228.34
18 Average (Pamb + PIT2 + L*p*Constant) (psi)	16.55	psia	311.649	0.8309	228.34
19 (Average + Maximum + Uncertainty)/2	16.64	psia	310.679	0.8314	228.34
20 Maximum + Uncertainty (PIT 2/16 + Pambient) (psi)	16.72	psia	309.824	0.8318	228.34
Decanes Plus Molecular Weight					
	Value	Units	FGOR	Shrinkage	B. Pt.
21 Minimum - U	208.231	gm/gm-mol	317.584	0.8280	229.02
22 (Average + Minimum - U)/2	210.732	gm/gm-mol	316.611	0.8285	228.84
23 Average	213.233	gm/gm-mol	315.645	0.8289	228.64
24 (Average + Maximum + U)/2	216.004	gm/gm-mol	314.583	0.8294	228.43
25 Maximum + U	218.774	gm/gm-mol	313.530	0.8298	228.20
Decanes Plus Density					
	Value	Units	FGOR	Shrinkage	B. Pt.
26 Minimum - U	0.8169	(H ₂ O=1)	313.265	0.8300	227.28
27 (Average + Minimum - U)/2	0.8195	(H ₂ O=1)	313.606	0.8298	227.68
28 Average	0.8221	(H ₂ O=1)	313.949	0.8297	228.09
29 (Average + Maximum + U)/2	0.8249	(H ₂ O=1)	314.321	0.8295	228.53
30 Maximum + U	0.8278	(H ₂ O=1)	314.709	0.8293	228.99

EOS Sensitivity Study - Summer Phase - Medium Pressure #3 - GPA 2103M					
Psep (psia)	Value	Units	FGOR	Shrinkage B. Pt.	
31	236.3	psia	311	0.8310	228.3
32	231.3	psia	307	0.8317	228.3
33	226.3	psia	303	0.8325	228.3
34	221.3	psia	299	0.8332	228.3
35	216.3	psia	295	0.8339	228.3
Tsep (°F)	Value	Units	FGOR	Shrinkage B. Pt.	
36	92.2	°F	311	0.8310	228.3
37	94.2	°F	309	0.8313	228.3
38	96.2	°F	308	0.8316	228.3
39	98.2	°F	306	0.8319	228.3
40	100.2	°F	304	0.8322	228.3
Siphon Prevention Hole	Value	Units	FGOR	Shrinkage B. Pt.	
41	0.00	(0-1)	306	0.8338	237.6
42	0.03	(0-1)	309	0.8323	237.6
43	0.06	(0-1)	312	0.8308	237.6
44	0.12	(0-1)	317	0.8279	237.6
45	0.24	(0-1)	328	0.8219	237.6
46	0.48	(0-1)	351	0.8101	237.6
47	1.00	(0-1)	402	0.7844	237.6

Summer Phase EOS Sensitivity Study MP3 GPA 2186M					
Tank Headspace temperature					
	Value	Units	FGOR	Shrinkage	B. Pt.
1 Minimum - Uncertainty (°F)	86.6	°F	300.557	0.8386	231.34
2 (Average + Minimum - Uncertainty)/2	88.1	°F	300.830	0.8384	231.34
3 Average (°F)	89.6	°F	301.106	0.8382	231.34
4 (Average + Maximum + Uncertainty)/2	91.2	°F	301.401	0.8381	231.34
5 Maximum + Uncertainty (°F)	92.7	°F	301.679	0.8379	231.34
Tank Headspace pressure					
	Value	Units	FGOR	Shrinkage	B. Pt.
6 Minimum -Uncertainty (PIT 2/16 + Pambient) (psi)	12.38	psia	301.325	0.8381	231.34
7 (Average + Minimum - Uncertainty)/2	12.47	psia	301.248	0.8382	231.34
8 Average (PIT 2/16 + Pambient) (psi)	12.55	psia	301.181	0.8382	231.34
9 (Average + Maximum + Uncertainty)/2	12.63	psia	301.114	0.8382	231.34
10 Maximum + Uncertainty (PIT 2/16 + Pambient) (psi)	12.72	psia	301.039	0.8383	231.34
Tank 1' from Bottom temperature					
	Value	Units	FGOR	Shrinkage	B. Pt.
11 Average -Uncertainty (°F)	78.8	°F	297.240	0.8403	231.34
12 Average -1/2 Uncertainty (°F)	79.5	°F	299.038	0.8394	231.34
13 Average	80.3	°F	301.106	0.8382	231.34
14 Average + 1/2 Uncertainty (°F)	81.0	°F	302.925	0.8373	231.34
15 Average + Uncertainty (°F)	81.8	°F	305.018	0.8361	231.34
Tank 1' from Bottom pressure					
	Value	Units	FGOR	Shrinkage	B. Pt.
16 Minimum -Uncertainty (psi)	16.39	psia	300.441	0.8386	231.34
17 (Average + Minimum - Uncertainty)/2	16.47	psia	299.686	0.8390	231.34
18 Average (Pamb + PIT2 + L*p*Constant) (psi)	16.55	psia	298.935	0.8394	231.34
19 (Average + Maximum + Uncertainty)/2	16.64	psia	298.097	0.8398	231.34
20 Maximum + Uncertainty (PIT 2/16 + Pambient) (psi)	16.72	psia	297.356	0.8402	231.34
Decanes Plus Molecular Weight					
	Value	Units	FGOR	Shrinkage	B. Pt.
21 Minimum - U	144.652	gm/gm-mol	302.138	0.8378	231.45
22 (Average + Minimum - U)/2	146.005	gm/gm-mol	300.924	0.8383	231.32
23 Average	147.359	gm/gm-mol	299.723	0.8389	231.18
24 (Average + Maximum + U)/2	148.443	gm/gm-mol	298.773	0.8393	231.08
25 Maximum + U	149.527	gm/gm-mol	297.831	0.8397	230.97
Decanes Plus Density					
	Value	Units	FGOR	Shrinkage	B. Pt.
26 Minimum - U	0.7515	(H ₂ O=1)	299.417	0.8390	230.16
27 (Average + Minimum - U)/2	0.7544	(H ₂ O=1)	299.983	0.8388	230.53
28 Average	0.7573	(H ₂ O=1)	300.553	0.8385	230.93
29 (Average + Maximum + U)/2	0.7606	(H ₂ O=1)	301.205	0.8382	231.41
30 Maximum + U	0.7639	(H ₂ O=1)	301.861	0.8379	231.92

EOS Sensitivity Study - Summer Phase - Medium Pressure #3 - GPA 2186M					
Psep (psia)	Value	Units	FGOR	Shrinkage B. Pt.	
31	236.3	psia	296	0.8399	240.6
32	231.3	psia	292	0.8405	240.6
33	226.3	psia	288	0.8412	240.6
34	221.3	psia	284	0.8418	240.6
35	216.3	psia	280	0.8425	240.6
Tsep (°F)	Value	Units	FGOR	Shrinkage B. Pt.	
36	90.2	°F	298	0.8395	240.6
37	92.2	°F	296	0.8398	240.6
38	94.2	°F	294	0.8401	240.6
39	96.2	°F	293	0.8404	240.6
40	98.2	°F	291	0.8410	240.6
Siphon Prevention Hole	Value	Units	FGOR	Shrinkage B. Pt.	
41	0.00	(0-1)	295	0.8418	240.6
42	0.03	(0-1)	297	0.8406	240.6
43	0.06	(0-1)	299	0.8394	240.6
44	0.12	(0-1)	303	0.8369	240.6
45	0.24	(0-1)	312	0.8321	240.6
46	0.48	(0-1)	331	0.8224	240.6
47	1.00	(0-1)	372	0.8013	240.6

Summer Phase EOS Sensitivity Study LP3 GPA 2103M					
Tank Headspace temperature					
	Value	Units	FGOR	Shrinkage	B. Pt.
1 Minimum - Uncertainty (°F)	91.1	°F	237.531	0.8651	178.79
2 (Average + Minimum - Uncertainty)/2	93.4	°F	238.057	0.8648	178.79
3 Average (°F)	95.8	°F	238.617	0.8645	178.79
4 (Average + Maximum + Uncertainty)/2	98.3	°F	239.212	0.8641	178.79
5 Maximum + Uncertainty (°F)	100.9	°F	239.845	0.8637	178.79
Tank Headspace pressure					
	Value	Units	FGOR	Shrinkage	B. Pt.
6 Minimum -Uncertainty (PIT 2/16 + Pambient) (psi)	12.38	psia	237.273	0.8653	178.79
7 (Average + Minimum - Uncertainty)/2	12.47	psia	237.183	0.8654	178.79
8 Average (PIT 2/16 + Pambient) (psi)	12.55	psia	237.104	0.8654	178.79
9 (Average + Maximum + Uncertainty)/2	12.63	psia	237.025	0.8655	178.79
10 Maximum + Uncertainty (PIT 2/16 + Pambient) (psi)	12.72	psia	236.937	0.8655	178.79
Tank 1' from Bottom temperature					
	Value	Units	FGOR	Shrinkage	B. Pt.
11 Average -Uncertainty (°F)	76.4	°F	238.636	0.8645	178.79
12 Average -1/2 Uncertainty (°F)	77.1	°F	240.544	0.8634	178.79
13 Average	77.9	°F	242.747	0.8621	178.79
14 Average + 1/2 Uncertainty (°F)	78.6	°F	244.693	0.861	178.79
15 Average + Uncertainty (°F)	79.4	°F	246.940	0.8597	178.79
Tank 1' from Bottom pressure					
	Value	Units	FGOR	Shrinkage	B. Pt.
16 Minimum -Uncertainty (psi)	16.48	psia	236.150	0.8660	178.79
17 (Average + Minimum - Uncertainty)/2	16.56	psia	235.388	0.8664	178.79
18 Average (Pamb + PIT2 + L*p*Constant) (psi)	16.64	psia	234.631	0.8668	178.79
19 (Average + Maximum + Uncertainty)/2	16.73	psia	233.786	0.8673	178.79
20 Maximum + Uncertainty (PIT 2/16 + Pambient) (psi)	16.81	psia	233.041	0.8677	178.79
Decanes Plus Molecular Weight					
	Value	Units	FGOR	Shrinkage	B. Pt.
21 Minimum - U	209.333	gm/gm-mol	239.054	0.8645	179.24
22 (Average + Minimum - U)/2	211.654	gm/gm-mol	238.397	0.8648	179.1
23 Average	213.975	gm/gm-mol	237.746	0.8651	178.96
24 (Average + Maximum + U)/2	216.119	gm/gm-mol	237.147	0.8654	178.82
25 Maximum + U	218.264	gm/gm-mol	236.553	0.8657	178.69
Decanes Plus Density					
	Value	Units	FGOR	Shrinkage	B. Pt.
26 Minimum - U	0.8174	(H ₂ O=1)	236.496	0.8657	178.19
27 (Average + Minimum - U)/2	0.8197	(H ₂ O=1)	236.729	0.8656	178.46
28 Average	0.8220	(H ₂ O=1)	236.964	0.8655	178.73
29 (Average + Maximum + U)/2	0.8243	(H ₂ O=1)	237.200	0.8654	179.01
30 Maximum + U	0.8266	(H ₂ O=1)	237.438	0.8652	179.29

EOS Sensitivity Study - Summer Phase - Low Pressure #3 - GPA 2103M					
Psep (psia)	Value	Units	FGOR	Shrinkage B. Pt.	
21	185.3	psia	245	0.8613	187.3
32	180.3	psia	240	0.8624	187.3
33	175.3	psia	236	0.8633	187.3
34	170.3	psia	232	0.8641	187.3
35	165.3	psia	228	0.8650	187.3
Tsep (°F)	Value	Units	FGOR	Shrinkage B. Pt.	
36	84.3	°F	244	0.8614	187.3
37	86.3	°F	243	0.8618	187.3
38	88.3	°F	241	0.8621	187.3
39	90.3	°F	240	0.8624	187.3
40	92.3	°F	238	0.8627	187.3
Siphon Prevention Hole	Value	Units	FGOR	Shrinkage B. Pt.	
41	0.00	(0-1)	238	0.8654	187.3
42	0.03	(0-1)	242	0.8634	187.3
43	0.06	(0-1)	245	0.8613	187.3
44	0.12	(0-1)	252	0.8572	187.3
45	0.24	(0-1)	266	0.8490	187.3
46	0.48	(0-1)	295	0.8325	187.3
47	1.00	(0-1)	363	0.7969	187.3

Summer Phase EOS Sensitivity Study LP3 GPA 2186M					
Tank Headspace temperature					
	Value	Units	FGOR	Shrinkage	B. Pt.
1 Minimum - Uncertainty (°F)	91.1	°F	231.531	0.8698	181.01
2 (Average + Minimum - Uncertainty)/2	93.4	°F	231.927	0.8695	181.01
3 Average (°F)	95.8	°F	232.343	0.8693	181.01
4 (Average + Maximum + Uncertainty)/2	98.3	°F	232.780	0.8690	181.01
5 Maximum + Uncertainty (°F)	100.9	°F	233.237	0.8687	181.01
Tank Headspace pressure					
	Value	Units	FGOR	Shrinkage	B. Pt.
6 Minimum -Uncertainty (PIT 2/16 + Pambient) (psi)	12.38	psia	231.345	0.8699	181.01
7 (Average + Minimum - Uncertainty)/2	12.47	psia	231.273	0.8699	181.01
8 Average (PIT 2/16 + Pambient) (psi)	12.55	psia	231.209	0.8699	181.01
9 (Average + Maximum + Uncertainty)/2	12.63	psia	231.145	0.8700	181.01
10 Maximum + Uncertainty (PIT 2/16 + Pambient) (psi)	12.72	psia	231.074	0.8700	181.01
Tank 1' from Bottom temperature					
	Value	Units	FGOR	Shrinkage	B. Pt.
11 Average -Uncertainty (°F)	76.4	°F	232.533	0.8692	181.01
12 Average -1/2 Uncertainty (°F)	77.1	°F	234.172	0.8682	181.01
13 Average	77.9	°F	236.056	0.8672	181.01
14 Average + 1/2 Uncertainty (°F)	78.6	°F	237.716	0.8662	181.01
15 Average + Uncertainty (°F)	79.4	°F	239.626	0.8651	181.01
Tank 1' from Bottom pressure					
	Value	Units	FGOR	Shrinkage	B. Pt.
16 Minimum -Uncertainty (psi)	16.48	psia	230.363	0.8704	181.01
17 (Average + Minimum - Uncertainty)/2	16.56	psia	229.679	0.8708	181.01
18 Average (Pamb + PIT2 + L*ρ*Constant) (psi)	16.64	psia	229.000	0.8712	181.010
19 (Average + Maximum + Uncertainty)/2	16.73	psia	228.242	0.8716	181.01
20 Maximum + Uncertainty (PIT 2/16 + Pambient) (psi)	16.81	psia	227.572	0.8720	181.01
Decanes Plus Molecular Weight					
	Value	Units	FGOR	Shrinkage	B. Pt.
21 Minimum - U	145.868	gm/gm-mol	232.994	0.8691	181.21
22 (Average + Minimum - U)/2	146.694	gm/gm-mol	232.388	0.8694	181.14
23 Average	147.520	gm/gm-mol	231.786	0.8697	181.08
24 (Average + Maximum + U)/2	148.544	gm/gm-mol	231.047	0.8700	181.00
25 Maximum + U	149.569	gm/gm-mol	230.313	0.8704	180.92
Decanes Plus Density					
	Value	Units	FGOR	Shrinkage	B. Pt.
26 Minimum - U	0.7515	(H ₂ O=1)	230.505	0.8703	180.61
27 (Average + Minimum - U)/2	0.7541	(H ₂ O=1)	230.937	0.8701	180.88
28 Average	0.7568	(H ₂ O=1)	231.389	0.8699	181.18
29 (Average + Maximum + U)/2	0.7592	(H ₂ O=1)	231.794	0.8697	181.46
30 Maximum + U	0.7617	(H ₂ O=1)	232.220	0.8695	181.77

EOS Sensitivity Study -Summer Phase - Low Pressure #3 - GPA 2186M					
Psep (psia)	Value	Units	FGOR	Shrinkage B. Pt.	
31	175.2	psia	225	0.8708	184.8
32	170.2	psia	221	0.8716	184.8
33	165.2	psia	217	0.8723	184.8
34	160.2	psia	213	0.8731	184.8
35	155.2	psia	209	0.8740	184.8
Tsep (°F)	Value	Units	FGOR	Shrinkage B. Pt.	
36	86.3	°F	232	0.8694	184.8
37	88.3	°F	230	0.8697	184.8
38	90.3	°F	229	0.8700	184.8
39	92.3	°F	227	0.8702	184.8
40	94.3	°F	226	0.8705	184.8
Siphon Prevention Hole	Value	Units	FGOR	Shrinkage B. Pt.	
41	0.00	(0-1)	226	0.8727	184.8
42	0.03	(0-1)	229	0.8711	184.8
43	0.06	(0-1)	232	0.8694	184.8
44	0.12	(0-1)	238	0.8660	184.8
45	0.24	(0-1)	249	0.8593	184.8
46	0.48	(0-1)	273	0.8458	184.8
47	1.00	(0-1)	327	0.8167	184.8

		Advanced Peng- Robinson	E- Soave- Redlich- Kwong	Bendict- Webb- Rubin- Starling	Refinery Soave- Redlich- Kwong- LK	Gibbs Excess Peng- Robinson	Chao Seader Peng- Robinson	Bendict- Webb- Rubin	
Winter HP-4 (GPA 2103M)	FGOR	345	321	366	333	332	334	415	scf/std. bbl.
	MB100	370	370	370	370	370	370	370	scf/std. bbl.
	$\frac{FGOR}{MB100}$	93%	87%	99%	90%	90%	90%	112%	%
	B. Pt.	259.6	286.9	250.3	239.9	226.3	193.5	285.3	psia
	Psep	263.3	263.3	263.3	263.3	263.3	263.3	263.3	psia
	$\frac{B.Pt.}{Psep}$	99%	109%	95%	91%	86%	73%	108%	%
Winter HP-4 (GPA 2186M)	FGOR	334	317	364	324	321	323	383	scf/std. bbl.
	MB100	370	370	370	370	370	370	370	scf/std. bbl.
	$\frac{FGOR}{MB100}$	90%	86%	98%	87%	87%	87%	103%	%
	B. Pt.	268.7	291.6	260.3	248.7	234.8	202.7	311.5	psia
	Psep	263.3	263.3	263.3	263.3	263.3	263.3	263.3	psia
	$\frac{B.Pt.}{Psep}$	102%	111%	99%	94%	89%	77%	118%	%
Winter MP-2 (GPA 2186M)	FGOR	199	187	218	198	196	195	225	scf/std. bbl.
	MB100	181	181	181	181	181	181	181	scf/std. bbl.
	$\frac{FGOR}{MB100}$	110%	103%	121%	109%	108%	108%	124%	%
	B. Pt.	237.3	250.6	235.4	220.4	205.3	181.0	279.6	psia
	Psep	227.2	227.2	227.2	227.2	227.2	227.2	227.2	psia
	$\frac{B.Pt.}{Psep}$	104%	110%	104%	97%	90%	80%	123%	%
Winter MP-2 (GPA 2103M)	FGOR	202	188	223	199	197	197	244	scf/std. bbl.
	MB100	181	181	181	181	181	181	181	scf/std. bbl.
	$\frac{FGOR}{MB100}$	112%	104%	123%	110%	109%	109%	135%	%
	B. Pt.	234.6	253.2	230.1	216.5	202.3	177.1	264.6	psia
	Psep	227.2	227.2	227.2	227.2	227.2	227.2	227.2	psia
	$\frac{B.Pt.}{Psep}$	103%	111%	101%	95%	89%	78%	116%	%
Winter LP-1 (GPA 2103M)	FGOR	143	133	161	140	138	138	180	scf/std. bbl.
	MB100	181	181	181	181	181	181	181	scf/std. bbl.
	$\frac{FGOR}{MB100}$	79%	73%	89%	78%	76%	76%	100%	%
	B. Pt.	184.0	198.0	175.2	169.2	158.1	138.1	204.1	psia
	Psep	178.5	178.5	178.5	178.5	178.5	178.5	178.5	psia
	$\frac{B.Pt.}{Psep}$	103%	111%	98%	95%	89%	77%	114%	%
Winter LP-1 (GPA 2186M)	FGOR	148	140	164	143	140	139	175	scf/std. bbl.
	MB100	181	181	181	181	181	181	181	scf/std. bbl.
	$\frac{FGOR}{MB100}$	82%	77%	91%	79%	77%	77%	97%	%
	B. Pt.	178.7	188.0	172.8	165.6	154.1	135.6	207.5	psia
	Psep	178.5	178.5	178.5	178.5	178.5	178.5	178.5	psia
	$\frac{B.Pt.}{Psep}$	100%	105%	97%	93%	86%	76%	116%	%

		Advanced Peng- Robinson	E- Soave- Redlich- Kwong	Bendict- Webb- Rubin- Starling	Refinery Soave- Redlich- Kwong- LK	Gibbs Excess Peng- Robinson	Chao Seader Peng- Robinson	Bendict- Webb- Rubin	
Summer HP-3 (GPA 2186M) ³	FGOR	339	332	361	330	328	330	391	scf/std. bbl.
	MB100	333	333	333	333	333	333	333	scf/std. bbl.
	$\frac{FGOR}{MB100}$	102%	100%	108%	99%	99%	99%	117%	%
	B. Pt.	250.0	270.0	244.1	231.6	216.9	238.6	285.4	psia
	$\frac{B.Pt.}{Psep}$	91%	98%	89%	84%	79%	87%	104%	%
Summer HP-3 (GPA 2103M) ³	FGOR	342	338	365	333	331	334	438	scf/std. bbl.
	MB100	333	333	333	333	333	333	333	scf/std. bbl.
	$\frac{FGOR}{MB100}$	103%	102%	110%	100%	99%	100%	132%	%
	B. Pt.	227.6	246.8	219.9	209.9	196.5	170.1	250.0	psia
	$\frac{B.Pt.}{Psep}$	83%	90%	80%	76%	72%	62%	91%	%
Summer MP-3 (GPA 2103M)	FGOR	314	302	341	305	303	306	390	scf/std. bbl.
	MB100	309	309	309	309	309	309	309	scf/std. bbl.
	$\frac{FGOR}{MB100}$	102%	98%	110%	99%	98%	99%	126%	%
	B. Pt.	228.3	248.8	218.0	209.9	196.8	180.6	250.2	psia
	$\frac{B.Pt.}{Psep}$	95%	104%	91%	87%	82%	75%	104%	%
Summer MP-3 (GPA 2186M)	FGOR	301	291	320	294	291	292	342	scf/std. bbl.
	MB100	309	309	309	309	309	309	309	scf/std. bbl.
	$\frac{FGOR}{MB100}$	97%	94%	104%	95%	94%	95%	111%	%
	B. Pt.	231.3	246.0	223.6	214.4	199.3	173.6	263.0	psia
	$\frac{B.Pt.}{Psep}$	96%	102%	93%	89%	83%	72%	109%	%
Summer LP-3 (GPA 2186M)	FGOR	222	218	242	215	213	213	283	scf/std. bbl.
	MB100	228	228	228	228	228	228	228	scf/std. bbl.
	$\frac{FGOR}{MB100}$	97%	96%	106%	94%	93%	93%	124%	%
	B. Pt.	173.2	187.2	166.5	160.7	150.5	203.1	197.9	psia
	$\frac{B.Pt.}{Psep}$	92%	100%	89%	86%	80%	108%	105%	%
Summer LP-3 (GPA 2103M)	FGOR	233	228	254	225	223	224	307	scf/std. bbl.
	MB100	228	228	228	228	228	228	228	scf/std. bbl.
	$\frac{FGOR}{MB100}$	102%	100%	111%	99%	98%	98%	135%	%
	B. Pt.	174.1	189.0	166.1	160.5	150.6	157.8	191.5	psia
	$\frac{B.Pt.}{Psep}$	93%	101%	89%	86%	80%	84%	102%	%

Appendix V.5 Monte Carlo Simulation Results**Winter PHLSA Study – HP4 – GPA 2103M****Crystal Ball Report - Full**

Simulation started on 5/1/2017 at 7:20 PM

Simulation stopped on 5/2/2017 at 1:23 PM

Run preferences:

Number of trials run	3,000
Monte Carlo	
Random seed	
Precision control on	
Confidence level	95.00%

Run statistics:

Total running time (sec)	64972.92
Trials/second (average)	0
Random numbers per sec	1

Crystal Ball data:

Assumptions	32
Correlations	0
Correlated groups	0
Decision variables	0
Forecasts	4

Forecasts**Worksheet: [Excel_HYSYS_PHLSA.xlsx]Input & Output****Forecast: Flash Gas to Oil Ratio (FGOR) - Standard (scf/bbl)****Cell: S34**

Summary:

Entire range is from 326.124 to 358.501

Base case is 341.566

After 3,000 trials, the std. error of the mean is 0.090

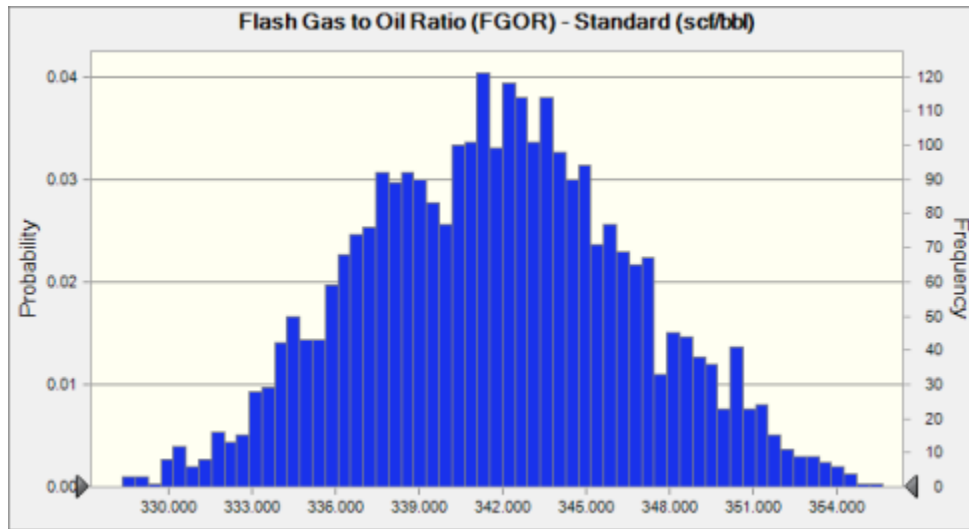

Statistics:	Forecast values
Trials	3,000
Base Case	341.566
Mean	341.765
Median	341.771
Mode	---
Standard Deviation	4.948
Variance	24.487
Skewness	0.0764
Kurtosis	2.78
Coeff. of Variability	0.0145
Minimum	326.124
Maximum	358.501
Range Width	32.376
Mean Std. Error	0.090

Forecast: Flash Gas to Oil Ratio (FGOR) - Standard (scf/bbl) (cont'd)

Cell: S34

Percentiles:	Forecast values
0%	326.124
10%	335.326
20%	337.442
30%	338.957
40%	340.513
50%	341.769
60%	343.001
70%	344.297
80%	345.957
90%	348.330
100%	358.501

Forecast: Flash MW

Cell: S29

Summary:

Entire range is from 37.730 to 38.742

Base case is 38.227

After 3,000 trials, the std. error of the mean is 0.003

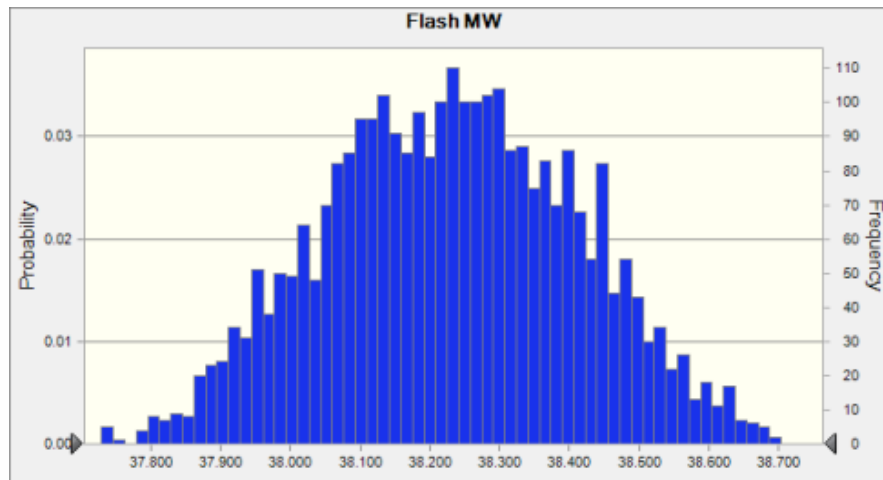

Statistics:	Forecast values
Trials	3,000
Base Case	38.227
Mean	38.230
Median	38.230
Mode	---
Standard Deviation	0.181
Variance	0.033
Skewness	0.0098
Kurtosis	2.50
Coeff. of Variability	0.0047
Minimum	37.730
Maximum	38.742
Range Width	1.012
Mean Std. Error	0.003

Forecast: Flash MW (cont'd)

Cell: S29

Percentiles:	Forecast values
0%	37.730
10%	37.991
20%	38.072
30%	38.125
40%	38.178
50%	38.230
60%	38.279
70%	38.331
80%	38.395
90%	38.466
100%	38.742

Forecast: Sample Bubble Point at Tsep

Cell: S6

Summary:

Entire range is from 247.23 to 266.71
 Base case is 257.65
 After 3,000 trials, the std. error of the mean is 0.05

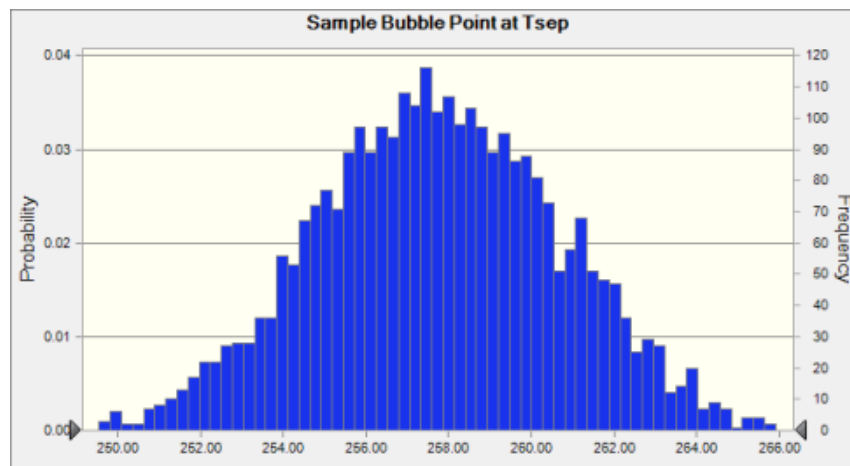

Statistics:	Forecast values
Trials	3,000
Base Case	257.65
Mean	257.73
Median	257.70
Mode	---
Standard Deviation	2.92
Variance	8.54
Skewness	-0.0185
Kurtosis	2.73
Coeff. of Variability	0.0113
Minimum	247.23
Maximum	266.71
Range Width	19.48
Mean Std. Error	0.05

Forecast: Sample Bubble Point at Tsep (cont'd)

Cell: S6

Percentiles:	Forecast values
0%	247.23
10%	253.99
20%	255.20
30%	256.14
40%	256.95
50%	257.70
60%	258.48
70%	259.29
80%	260.26
90%	261.56
100%	266.71

Forecast: Shrinkage Factor

Cell: S37

Summary:

Entire range is from 0.834 to 0.848
 Base case is 0.841
 After 3,000 trials, the std. error of the mean is 0.000

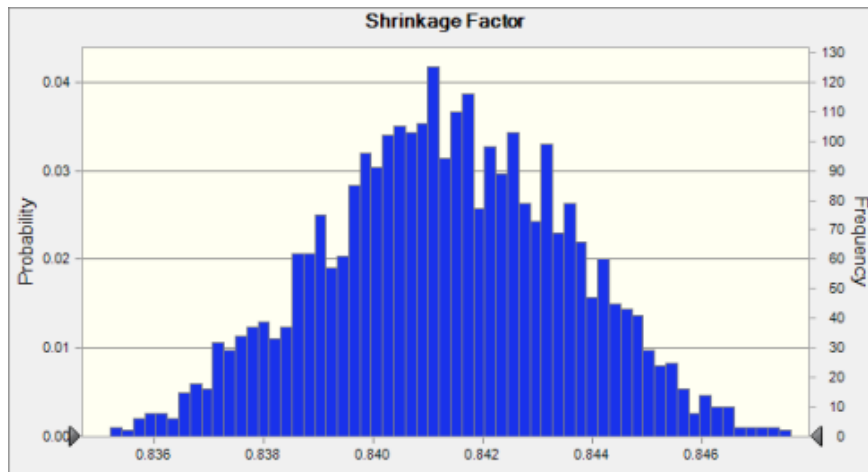

Statistics:	Forecast values
Trials	3,000
Base Case	0.841
Mean	0.841
Median	0.841
Mode	---
Standard Deviation	0.002
Variance	0.000
Skewness	-0.0612
Kurtosis	2.73
Coeff. of Variability	0.0027
Minimum	0.834
Maximum	0.848
Range Width	0.014
Mean Std. Error	0.000

Forecast: Shrinkage Factor (cont'd)

Cell: S37

Percentiles:	Forecast values
0%	0.834
10%	0.838
20%	0.839
30%	0.840
40%	0.841
50%	0.841
60%	0.842
70%	0.843
80%	0.843
90%	0.844
100%	0.848

End of Forecasts

Assumptions

Worksheet: [Excel_HYSYS_PHLA.xlsx]Input & Output

Assumption: 2,2,4-Trimethylpentane

Cell: F22

Normal distribution with parameters:
 Mean 0.041
 Std. Dev. 0.000

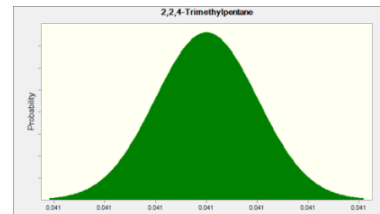

Assumption: 2,2-Dimethylbutane

Cell: F23

Normal distribution with parameters:
 Mean 0.099
 Std. Dev. 0.000

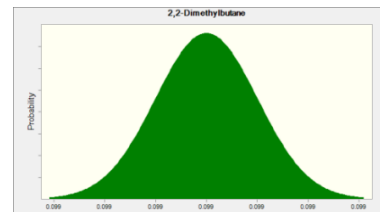

Assumption: 2,3-Dimethylbutane

Cell: F24

Normal distribution with parameters:
 Mean 0.339
 Std. Dev. 0.001

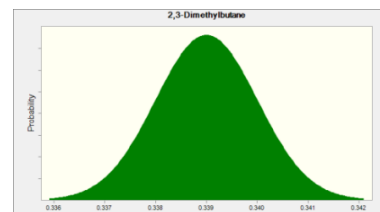

Assumption: 2-Methylpentane

Cell: F26

Normal distribution with parameters:

Mean

3.102

Std. Dev.

0.007

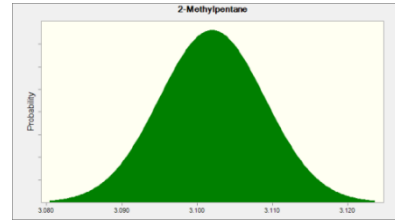

Assumption: 3-Methylpentane

Cell: F27

Normal distribution with parameters:

Mean

1.899

Std. Dev.

0.004

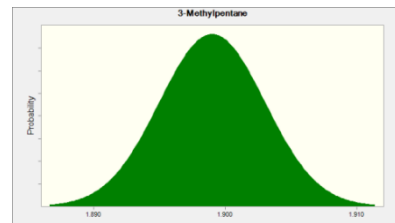

Assumption: Benzene

Cell: F17

Normal distribution with parameters:

Mean

0.783

Std. Dev.

0.021

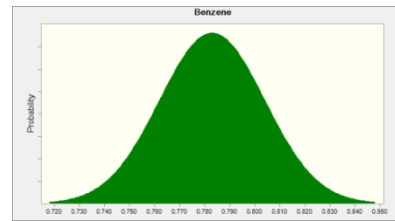

Assumption: Carbon Dioxide

Cell: F3

Normal distribution with parameters:

Mean

0.502

Std. Dev.

0.004

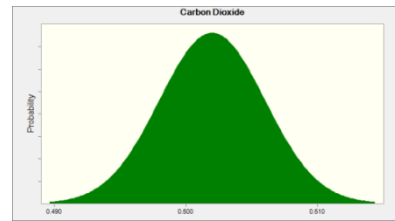

Assumption: Cyclopentane

Cell: F25

Normal distribution with parameters:

Mean 0.418
Std. Dev. 0.001

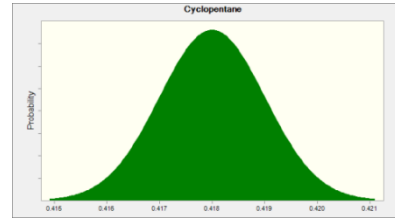

Assumption: Decanes Plus

Cell: F16

Normal distribution with parameters:

Mean 7.697
Std. Dev. 0.099

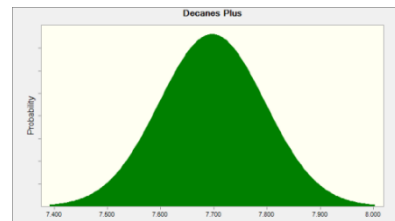

Assumption: Discharge Through Siphon Hole (fraction, 0-1)

Cell: S8

Uniform distribution with parameters:

Minimum 0.04
Maximum 0.08

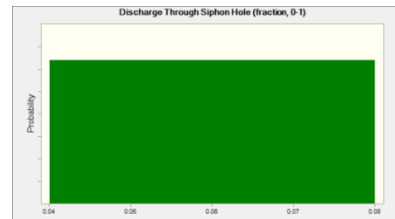

Assumption: Ethane

Cell: F6

Normal distribution with parameters:

Mean 7.400
Std. Dev. 0.058

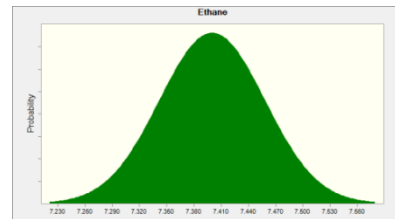

Assumption: Ethylbenzene

Cell: F19

Normal distribution with parameters:

Mean 0.149
Std. Dev. 0.014

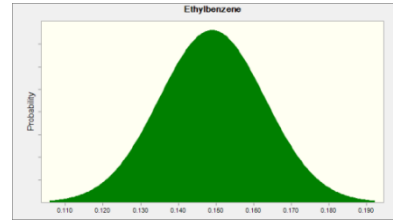

Assumption: Heptanes

Cell: F13

Normal distribution with parameters:

Mean 12.297
Std. Dev. 0.187

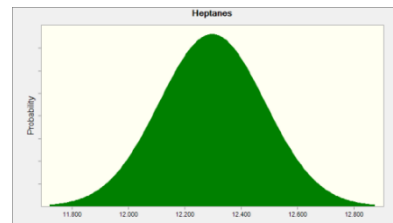

Assumption: Iso-Butane

Cell: F8

Normal distribution with parameters:

Mean 2.863
Std. Dev. 0.013

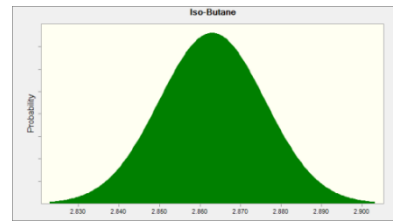

Assumption: Iso-Pentane

Cell: F10

Normal distribution with parameters:

Mean 6.069
Std. Dev. 0.071

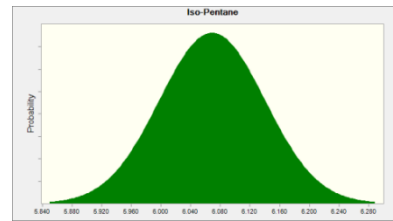

Assumption: m,p-Xylene (100% meta)

Cell: F20

Normal distribution with parameters:

Mean 1.584
Std. Dev. 0.021

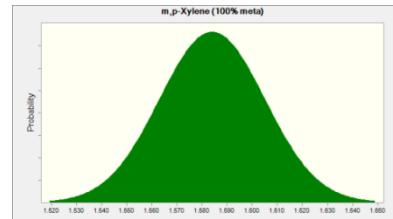

Assumption: Methane

Cell: F5

Normal distribution with parameters:

Mean 7.357
Std. Dev. 0.080

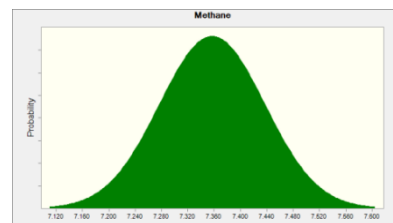

Assumption: n-Butane

Cell: F9

Normal distribution with parameters:

Mean 8.915
Std. Dev. 0.046

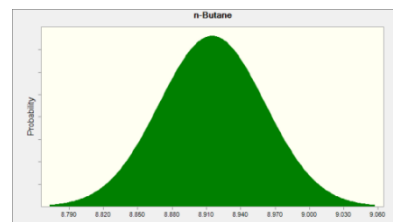

Assumption: n-Hexane

Cell: F12

Normal distribution with parameters:

Mean 5.888
Std. Dev. 0.128

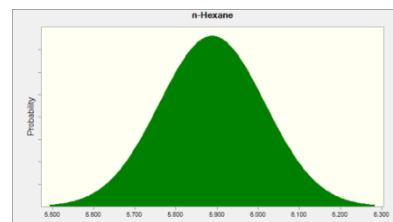

Assumption: Nonanes

Cell: F15

Normal distribution with parameters:

Mean

3.761

Std. Dev.

0.048

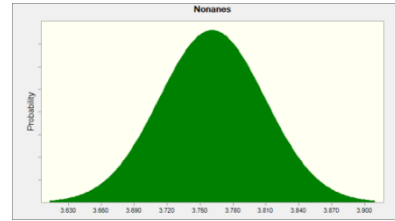

Assumption: n-Pentane

Cell: F11

Normal distribution with parameters:

Mean

8.256

Std. Dev.

0.034

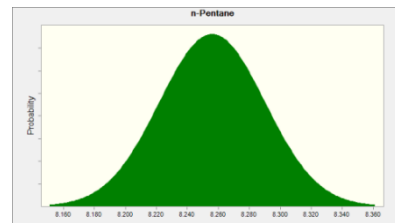

Assumption: Octanes

Cell: F14

Normal distribution with parameters:

Mean

8.997

Std. Dev.

0.294

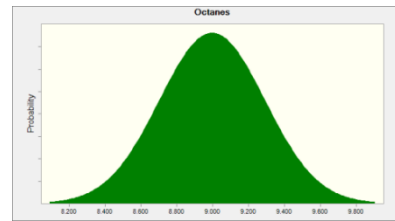

Assumption: o-Xylene

Cell: F21

Normal distribution with parameters:

Mean

0.390

Std. Dev.

0.005

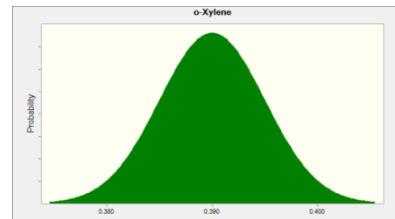

Assumption: Propane

Cell: F7

Normal distribution with parameters:

Mean 8.716
Std. Dev. 0.057

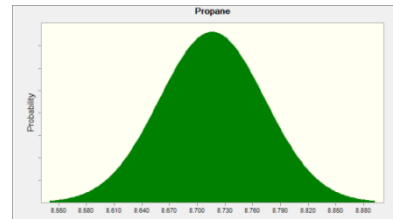

Assumption: Separator Pressure

Cell: S7

Uniform distribution with parameters:

Minimum 270.03
Maximum 281.23

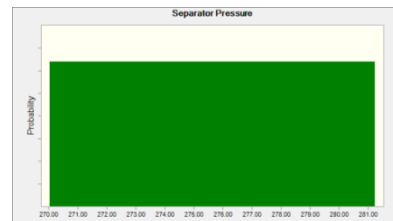

Assumption: Separator Temperature

Cell: S5

Uniform distribution with parameters:

Minimum 56.31
Maximum 60.29

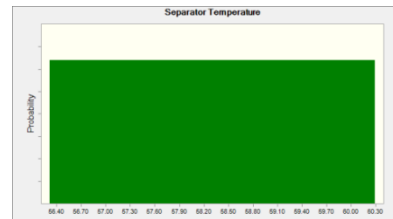

Assumption: Tank Bottom Pressure

Cell: S12

Normal distribution with parameters:

Mean 15.81
Std. Dev. 0.07

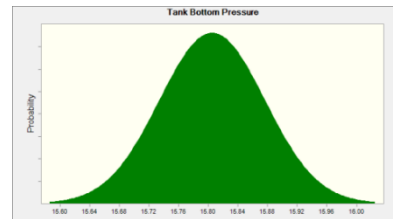

Assumption: Tank Bottom Temperature

Cell: S11

Uniform distribution with parameters:

Minimum

43.79

Maximum

46.81

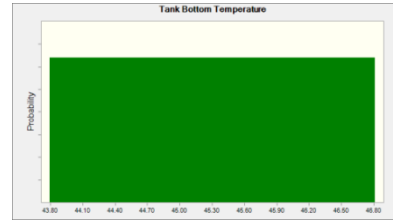

Assumption: Tank HS Pressure

Cell: S10

Uniform distribution with parameters:

Minimum

12.43

Maximum

12.67

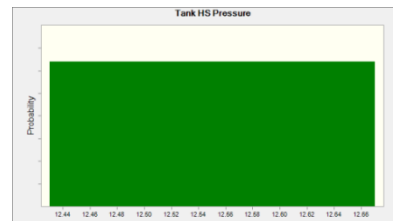

Assumption: Tank HS Temperature

Cell: S9

Uniform distribution with parameters:

Minimum

68.18

Maximum

72.22

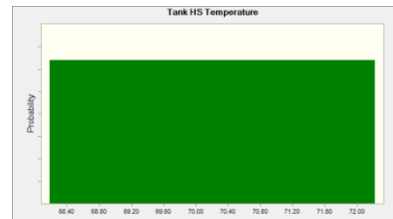

Assumption: Toluene

Cell: F18

Normal distribution with parameters:

Mean

2.478

Std. Dev.

0.027

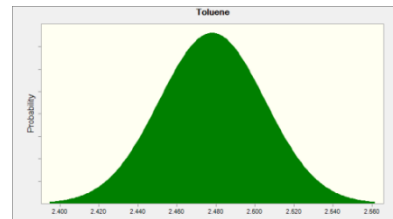

Assumption: Volume Flow (Std. Bbl)

Cell: F40

Normal distribution with parameters:

Mean 0.652
 Std. Dev. 0.002

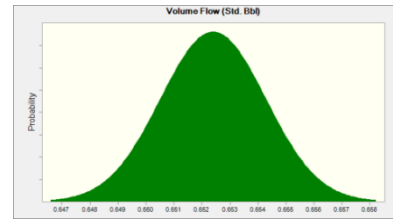

End of Assumptions

Winter PHLSA Study – HP4 – GPA 2186M

Crystal Ball Report - Full

Simulation started on 4/30/2017 at 1:09 PM
 Simulation stopped on 5/1/2017 at 8:22 AM

Run preferences:

Number of trials run 3,000
 Monte Carlo
 Random seed
 Precision control on
 Confidence level 95.00%

Run statistics:

Total running time (sec) 69185.52
 Trials/second (average) 0
 Random numbers per sec 1

Crystal Ball data:

Assumptions 32
 Correlations 0
 Correlated groups 0
 Decision variables 0
 Forecasts 4

Forecasts

Worksheet: [Excel_HYSYS_PHLSA.xlsx]Input & Output

Forecast: Flash Gas to Oil Ratio (FGOR) - Standard (scf/bbl)

Cell: S34

Summary:

Entire range is from 319.728 to 357.052
 Base case is 338.101
 After 3,000 trials, the std. error of the mean is 0.099

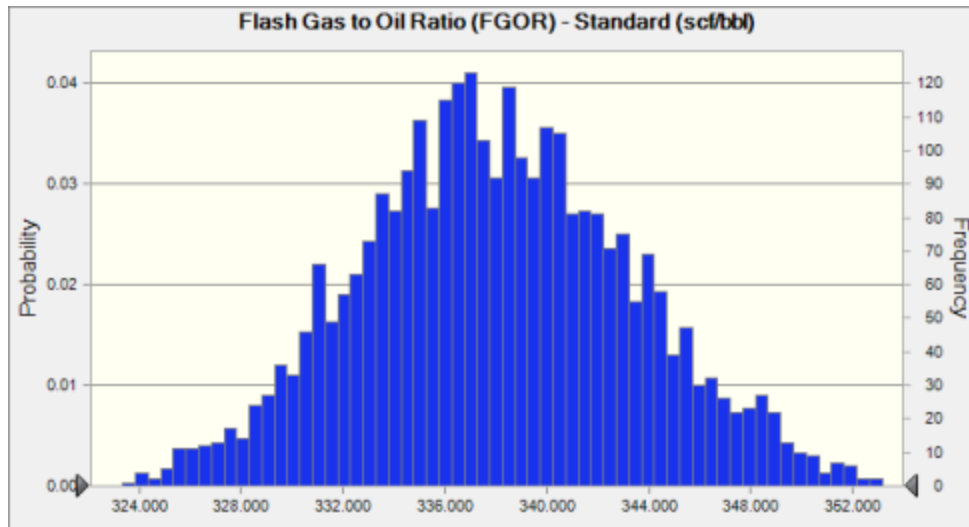

Statistics:	Forecast values
Trials	3,000
Base Case	338.101
Mean	338.005
Median	337.863
Mode	---
Standard Deviation	5.411
Variance	29.283
Skewness	0.0863
Kurtosis	2.92
Coeff. of Variability	0.0160
Minimum	319.728
Maximum	357.052
Range Width	37.324
Mean Std. Error	0.099

Forecast: Flash Gas to Oil Ratio (FGOR) - Standard (scf/bbl) (cont'd)

Cell: S34

Percentiles:	Forecast values
0%	319.728
10%	331.084
20%	333.419
30%	335.077
40%	336.486
50%	337.861
60%	339.263
70%	340.736
80%	342.620
90%	345.054
100%	357.052

Forecast: Flash MW

Cell: S29

Summary:

Entire range is from 37.076 to 38.113

Base case is 37.570

After 3,000 trials, the std. error of the mean is 0.003

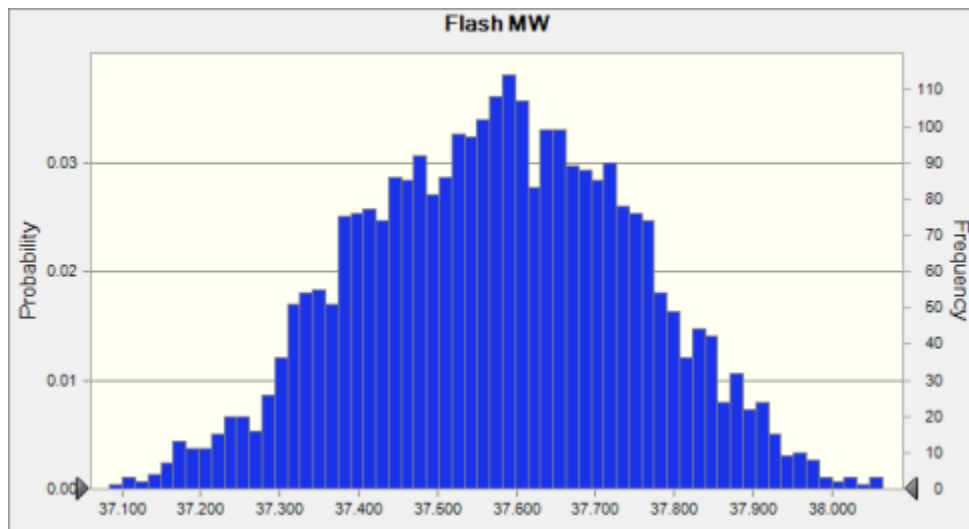

Statistics:	Forecast values
Trials	3,000
Base Case	37.570
Mean	37.574
Median	37.577
Mode	---
Standard Deviation	0.175
Variance	0.031
Skewness	-0.0270
Kurtosis	2.59
Coeff. of Variability	0.0046
Minimum	37.076
Maximum	38.113
Range Width	1.037
Mean Std. Error	0.003

Forecast: Flash MW (cont'd)

Cell: S29

Percentiles:	Forecast values
0%	37.076
10%	37.343
20%	37.417
30%	37.475
40%	37.531
50%	37.577
60%	37.622
70%	37.673
80%	37.729
90%	37.799
100%	38.113

Forecast: Sample Bubble Point at Tsep

Cell: S6

Summary:

Entire range is from 253.80 to 280.48

Base case is 267.67

After 3,000 trials, the std. error of the mean is 0.08

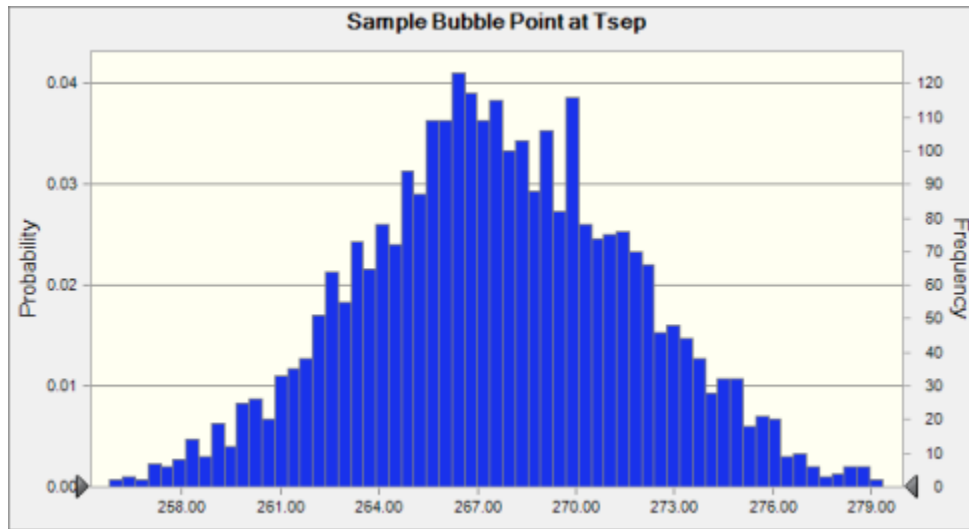

Statistics:	Forecast values
Trials	3,000
Base Case	267.67
Mean	267.57
Median	267.48
Mode	---
Standard Deviation	4.20
Variance	17.66
Skewness	0.0111
Kurtosis	2.89
Coeff. of Variability	0.0157
Minimum	253.80
Maximum	280.48
Range Width	26.68
Mean Std. Error	0.08

Forecast: Sample Bubble Point at Tsep (cont'd)

Cell: S6

Percentiles:	Forecast values
0%	253.80
10%	262.24
20%	264.01
30%	265.42
40%	266.46
50%	267.48
60%	268.57
70%	269.80
80%	271.13
90%	273.07
100%	280.48

Forecast: Shrinkage Factor

Cell: S37

Summary:

Entire range is from 0.838 to 0.853

Base case is 0.845

After 3,000 trials, the std. error of the mean is 0.000

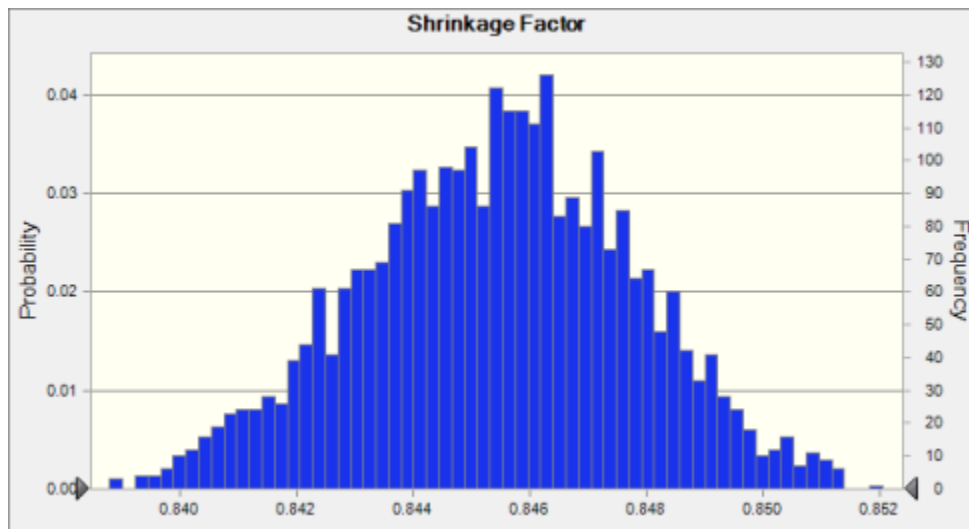

Statistics:	Forecast values
Trials	3,000
Base Case	0.845
Mean	0.845
Median	0.846
Mode	---
Standard Deviation	0.002
Variance	0.000
Skewness	-0.0718
Kurtosis	2.86
Coeff. of Variability	0.0028
Minimum	0.838
Maximum	0.853
Range Width	0.016
Mean Std. Error	0.000

Forecast: Shrinkage Factor (cont'd)

Cell: S37

Percentiles:	Forecast values
0%	0.838
10%	0.842
20%	0.843
30%	0.844
40%	0.845
50%	0.846
60%	0.846
70%	0.847
80%	0.847
90%	0.848
100%	0.853

End of Forecasts

Assumptions

Worksheet: [Excel_HYSYS_PHLA.xlsx]Input & Output

Assumption: 2,2,4-Trimethylpentane

Cell: F22

Normal distribution with parameters:

Mean

0.040

Std. Dev.

0.000

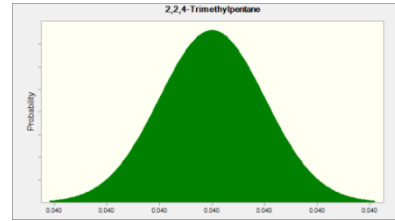

Assumption: 2,2-Dimethylbutane

Cell: F23

Normal distribution with parameters:

Mean

0.048

Std. Dev.

0.000

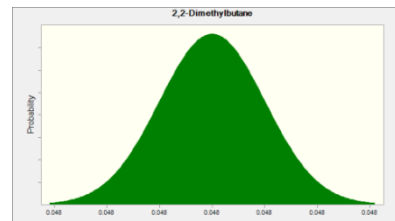

Assumption: 2,3-Dimethylbutane

Cell: F24

Normal distribution with parameters:

Mean

0.155

Std. Dev.

0.000

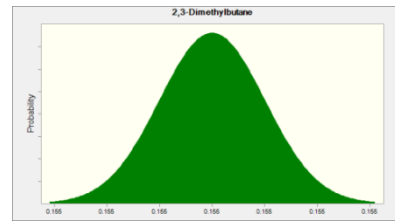

Assumption: 2-Methylpentane

Cell: F26

Normal distribution with parameters:

Mean

1.089

Std. Dev.

0.002

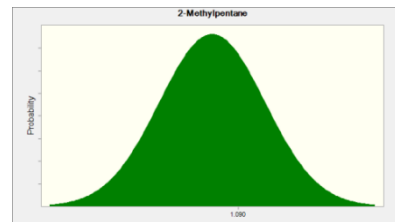

Assumption: 3-Methylpentane

Cell: F27

Normal distribution with parameters:

Mean 0.617
Std. Dev. 0.001

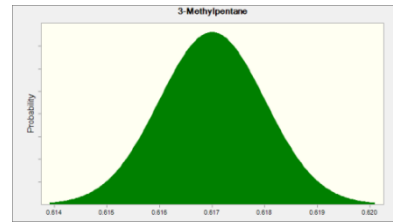

Assumption: Benzene

Cell: F17

Normal distribution with parameters:

Mean 0.251
Std. Dev. 0.005

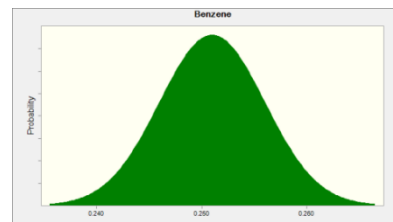

Assumption: Carbon Dioxide

Cell: F3

Normal distribution with parameters:

Mean 0.526
Std. Dev. 0.016

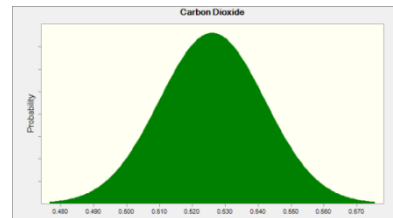

Assumption: Cyclopentane

Cell: F25

Normal distribution with parameters:

Mean 0.190
Std. Dev. 0.000

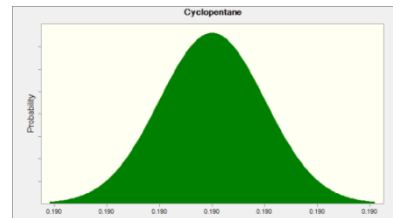

Assumption: Decanes Plus

Cell: F16

Normal distribution with parameters:

Mean 25.152
Std. Dev. 0.398

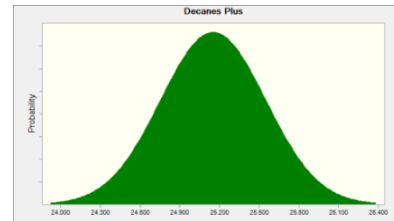

Assumption: Discharge Through Siphon Hole (fraction, 0-1)

Cell: S8

Uniform distribution with parameters:

Minimum 0.04
Maximum 0.08

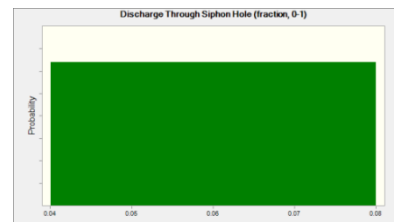

Assumption: Ethane

Cell: F6

Normal distribution with parameters:

Mean 7.593
Std. Dev. 0.054

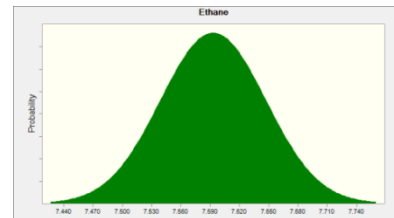

Assumption: Ethylbenzene

Cell: F19

Normal distribution with parameters:

Mean 0.076
Std. Dev. 0.006

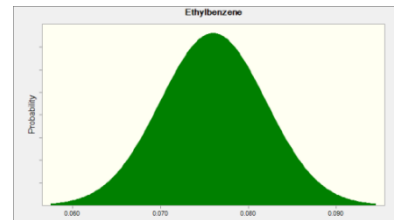

Assumption: Heptanes

Cell: F13

Normal distribution with parameters:

Mean 8.967
Std. Dev. 0.051

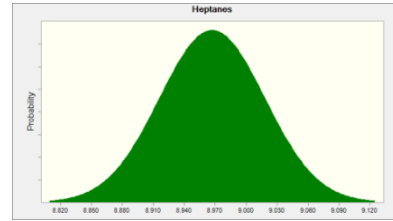

Assumption: Iso-Butane

Cell: F8

Normal distribution with parameters:

Mean 2.887
Std. Dev. 0.015

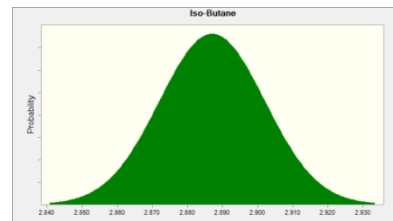

Assumption: Iso-Pentane

Cell: F10

Normal distribution with parameters:

Mean 6.020
Std. Dev. 0.104

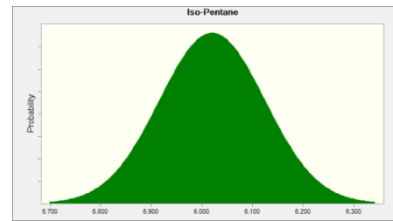

Assumption: m,p-Xylene (100% meta)

Cell: F20

Normal distribution with parameters:

Mean 0.821
Std. Dev. 0.005

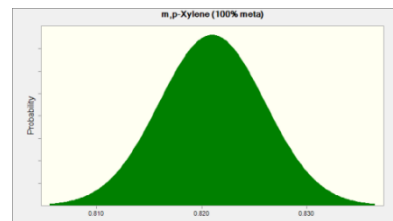

Assumption: Methane

Cell: F5

Normal distribution with parameters:

Mean

7.741

Std. Dev.

0.140

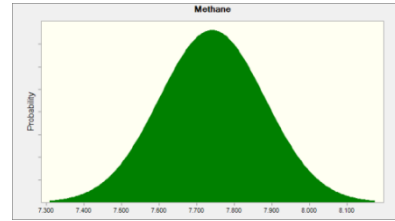

Assumption: n-Butane

Cell: F9

Normal distribution with parameters:

Mean

9.197

Std. Dev.

0.036

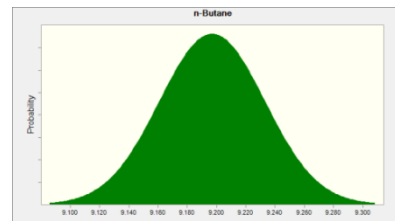

Assumption: n-Hexane

Cell: F12

Normal distribution with parameters:

Mean

1.802

Std. Dev.

0.008

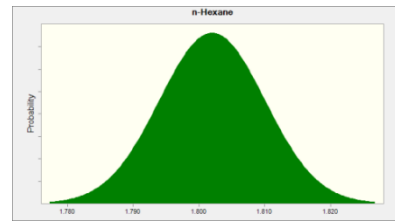

Assumption: Nonanes

Cell: F15

Normal distribution with parameters:

Mean

2.167

Std. Dev.

0.033

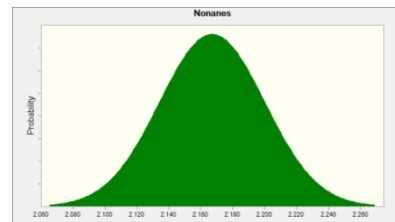

Assumption: n-Pentane

Cell: F11

Normal distribution with parameters:

Mean 8.120
Std. Dev. 0.030

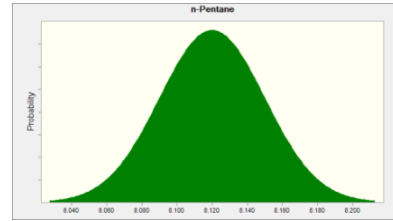

Assumption: Octanes

Cell: F14

Normal distribution with parameters:

Mean 6.541
Std. Dev. 0.135

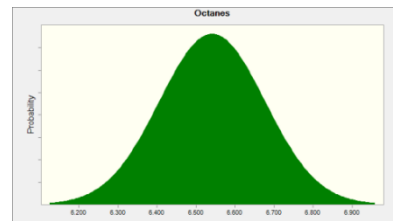

Assumption: o-Xylene

Cell: F21

Normal distribution with parameters:

Mean 0.173
Std. Dev. 0.001

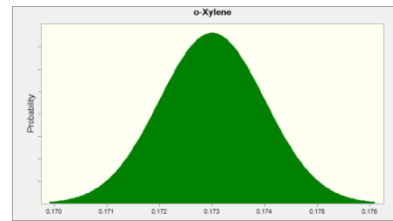

Assumption: Propane

Cell: F7

Normal distribution with parameters:

Mean 8.830
Std. Dev. 0.071

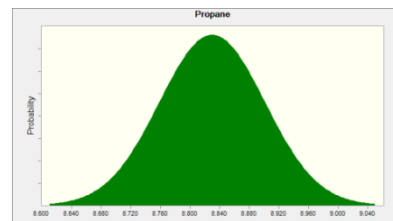

Assumption: Separator Pressure

Cell: S7

Uniform distribution with parameters:

Minimum 270.03
Maximum 281.23

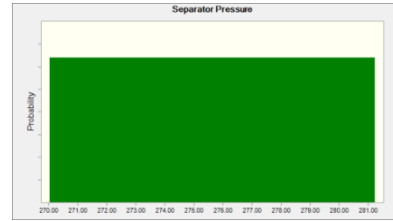

Assumption: Separator Temperature

Cell: S5

Uniform distribution with parameters:

Minimum 56.31
Maximum 60.29

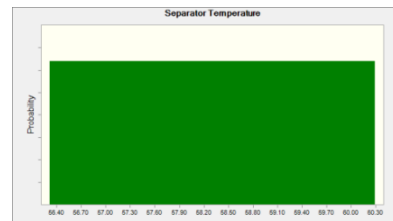

Assumption: Tank Bottom Pressure

Cell: S12

Normal distribution with parameters:

Mean 15.81
Std. Dev. 0.07

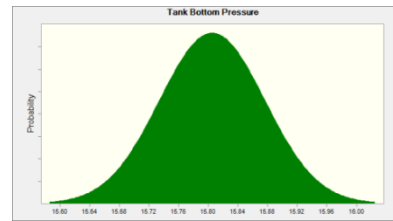

Assumption: Tank Bottom Temperature

Cell: S11

Uniform distribution with parameters:

Minimum 43.80
Maximum 46.80

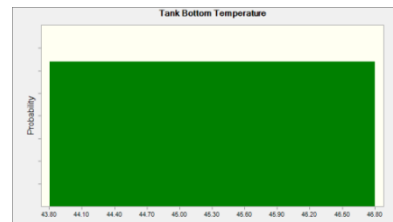

Assumption: Tank HS Pressure

Cell: S10

Uniform distribution with parameters:
 Minimum 12.43
 Maximum 12.67

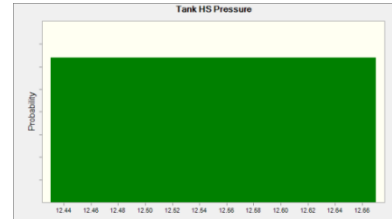

Assumption: Tank HS Temperature

Cell: S9

Uniform distribution with parameters:
 Minimum 68.18
 Maximum 72.22

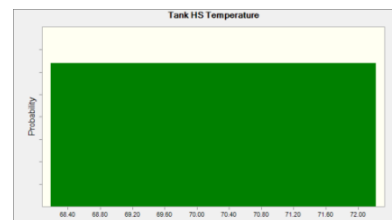

Assumption: Toluene

Cell: F18

Normal distribution with parameters:
 Mean 0.997
 Std. Dev. 0.006

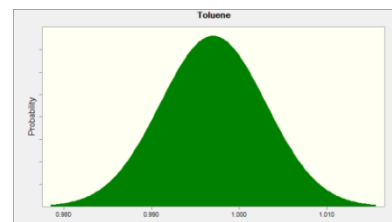

Assumption: Volume Flow (Std. Bbl)

Cell: F40

Normal distribution with parameters:
 Mean 0.652
 Std. Dev. 0.002

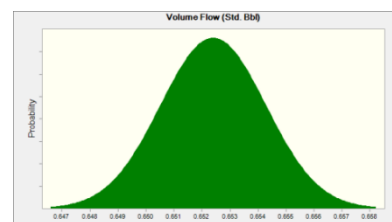

End of Assumptions

Crystal Ball Report - Full

Simulation started on 5/4/2017 at 8:06 PM
 Simulation stopped on 5/5/2017 at 3:10 PM

Run preferences:

Number of trials run	3,000
Monte Carlo	
Random seed	
Precision control on	
Confidence level	95.00%

Run statistics:

Total running time (sec)	68629.66
Trials/second (average)	0
Random numbers per sec	1

Crystal Ball data:

Assumptions	32
Correlations	0
Correlated groups	0
Decision variables	0
Forecasts	4

Forecasts

Worksheet: [Excel_HYSYS_PHLSA.xlsx]Input & Output

Forecast: Flash Gas to Oil Ratio (FGOR) - Standard (scf/bbl)

Cell: S34

Summary:

Entire range is from 197.101 to 218.230
 Base case is 207.238
 After 3,000 trials, the std. error of the mean is 0.057

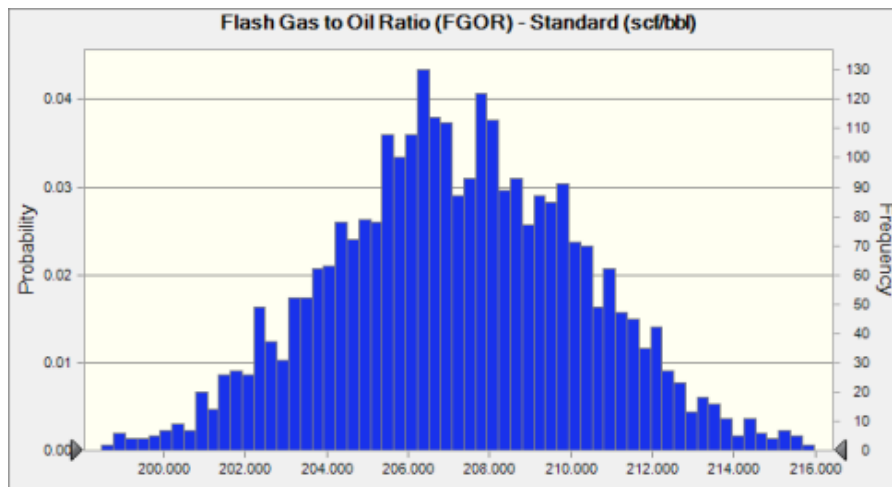

Statistics:	Forecast values
Trials	3,000
Base Case	207.238
Mean	207.220
Median	207.126
Mode	---
Standard Deviation	3.123
Variance	9.752
Skewness	0.0622
Kurtosis	2.90
Coeff. of Variability	0.0151
Minimum	197.101
Maximum	218.230
Range Width	21.129
Mean Std. Error	0.057

Forecast: Flash Gas to Oil Ratio (FGOR) - Standard (scf/bbl) (cont'd)**Cell: S34**

Percentiles:	Forecast values
0%	197.101
10%	203.190
20%	204.579
30%	205.574
40%	206.372
50%	207.126
60%	207.980
70%	208.888
80%	209.873
90%	211.255
100%	218.230

Forecast: Flash MW**Cell: S29****Summary:**

Entire range is from 36.691 to 37.925

Base case is 37.351

After 3,000 trials, the std. error of the mean is 0.004

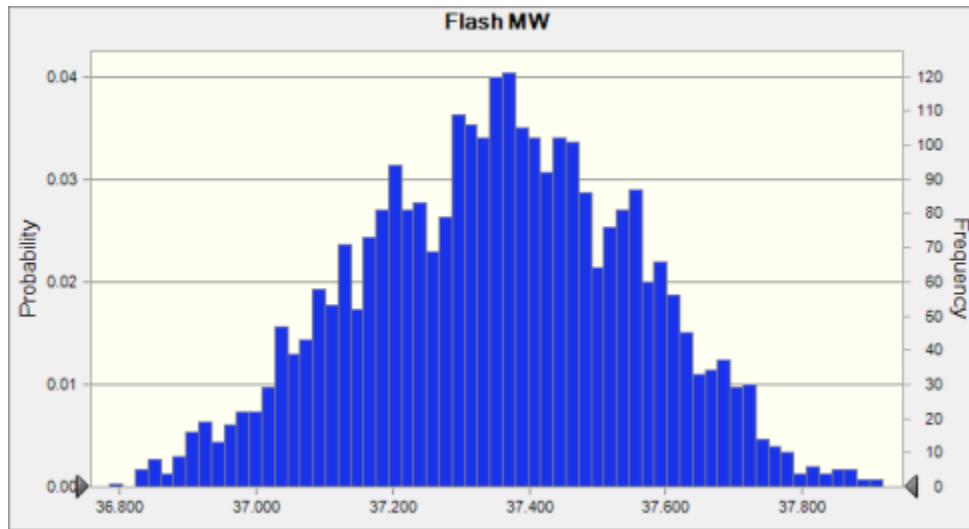

Statistics:	Forecast values
Trials	3,000
Base Case	37.351
Mean	37.351
Median	37.356
Mode	37.469
Standard Deviation	0.202
Variance	0.041
Skewness	-0.0679
Kurtosis	2.63
Coeff. of Variability	0.0054
Minimum	36.691
Maximum	37.925
Range Width	1.234
Mean Std. Error	0.004

Forecast: Flash MW (cont'd)

Cell: S29

Percentiles:	Forecast values
0%	36.691
10%	37.084
20%	37.175
30%	37.241
40%	37.305
50%	37.356
60%	37.406
70%	37.463
80%	37.532
90%	37.612
100%	37.925

Forecast: Sample Bubble Point at Tsep

Cell: S6

Summary:

Entire range is from 225.20 to 242.75

Base case is 234.11

After 3,000 trials, the std. error of the mean is 0.05

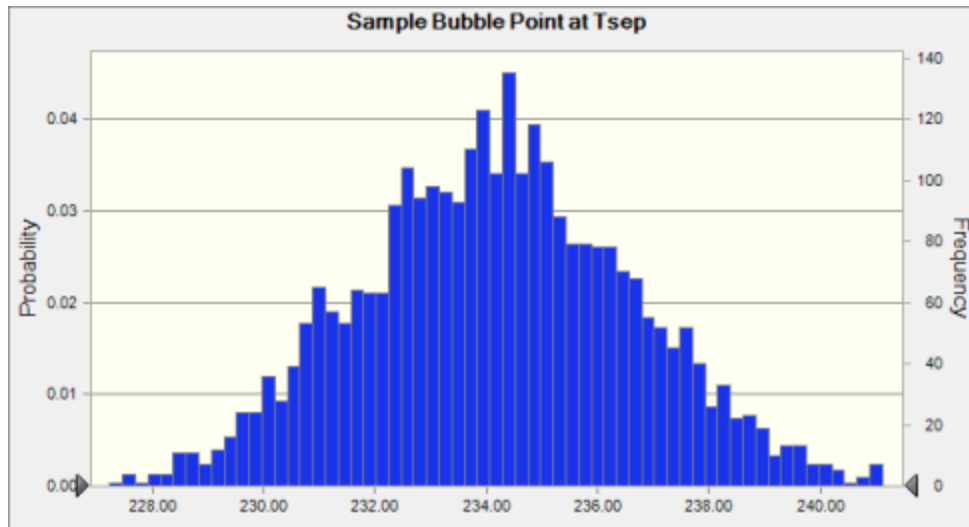

Statistics:

Forecast values

Trials	3,000
Base Case	234.11
Mean	234.18
Median	234.17
Mode	---
Standard Deviation	2.48
Variance	6.13
Skewness	0.0806
Kurtosis	2.94
Coeff. of Variability	0.0106
Minimum	225.20
Maximum	242.75
Range Width	17.55
Mean Std. Error	0.05

Forecast: Sample Bubble Point at Tsep (cont'd)

Cell: \$

Percentiles:	Forecast values
0%	225.20
10%	230.96
20%	232.08
30%	232.86
40%	233.56
50%	234.17
60%	234.77
70%	235.41
80%	236.29
90%	237.41
100%	242.75

Forecast: Shrinkage Factor

Cell: S

Summary:

Entire range is from 0.895 to 0.906

Base case is 0.900

After 3,000 trials, the std. error of the mean is 0.000

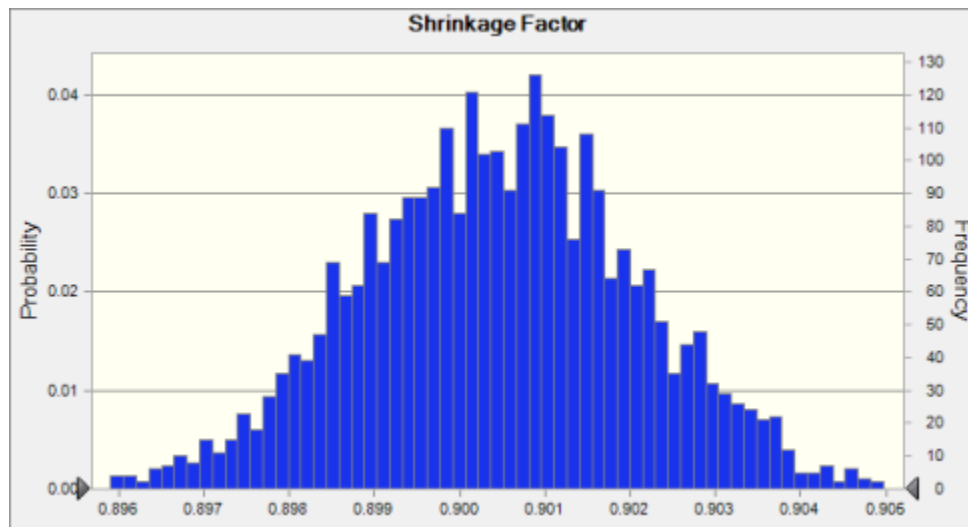

Statistics:	Forecast values
Trials	3,000
Base Case	0.900
Mean	0.900
Median	0.900
Mode	---
Standard Deviation	0.002
Variance	0.000
Skewness	-0.0444
Kurtosis	2.86
Coeff. of Variability	0.0018
Minimum	0.895
Maximum	0.906
Range Width	0.011
Mean Std. Error	0.000

Forecast: Shrinkage Factor (cont'd)

Cell: S37

Percentiles:	Forecast values
0%	0.895
10%	0.898
20%	0.899
30%	0.900
40%	0.900
50%	0.900
60%	0.901
70%	0.901
80%	0.902
90%	0.903
100%	0.906

End of Forecasts

Assumptions

Worksheet: [Excel_HYSYS_PHLA.xlsx]Input & Output

Assumption: 2,2,4-Trime thylpenta ne

Cell: F22

Normal distribution with parameters:	
Mean	0.040
Std. Dev.	0.000

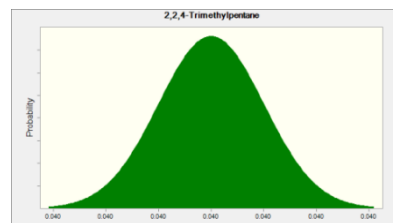

Assumption: 2,2-Dimethylbutane

Cell: F23

Normal distribution with parameters:

Mean

0.088

Std. Dev.

0.000

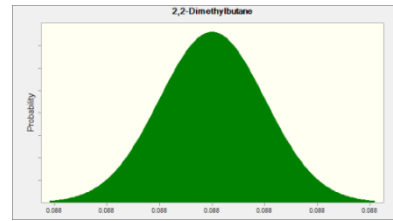

Assumption: 2,3-Dimethylbutane

Cell: F24

Normal distribution with parameters:

Mean

0.309

Std. Dev.

0.001

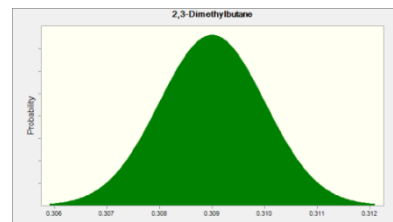

Assumption: 2-Methylpentane

Cell: F26

Normal distribution with parameters:

Mean

2.979

Std. Dev.

0.007

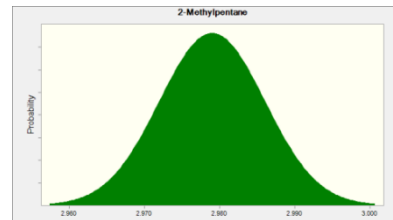

Assumption: 3-Methylpentane

Cell: F27

Normal distribution with parameters:

Mean

1.881

Std. Dev.

0.004

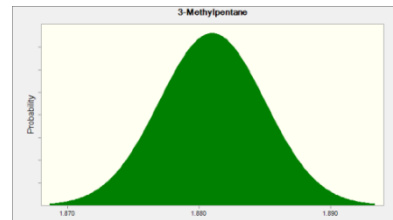

Assumption: Benzene

Cell: F17

Normal distribution with parameters:

Mean 0.814
Std. Dev. 0.022

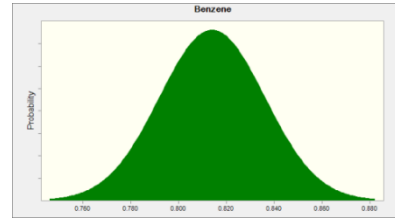

Assumption: Carbon Dioxide

Cell: F3

Normal distribution with parameters:

Mean 0.368
Std. Dev. 0.003

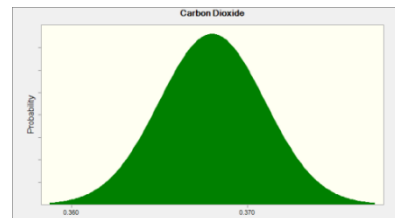

Assumption: Cyclopentane

Cell: F25

Normal distribution with parameters:

Mean 0.381
Std. Dev. 0.001

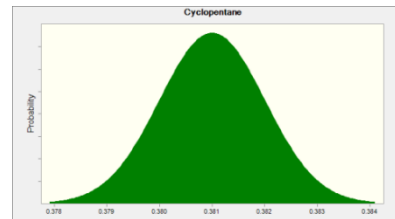

Assumption: Decanes Plus

Cell: F16

Normal distribution with parameters:

Mean 12.427
Std. Dev. 0.160

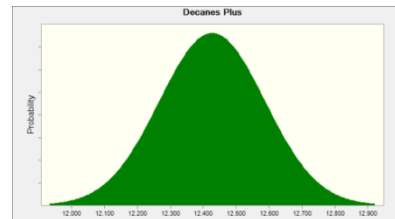

Assumption: Discharge Through Siphon Hole (fraction, 0-1)

Cell: S8

Uniform distribution with parameters:

Minimum 0.04
Maximum 0.08

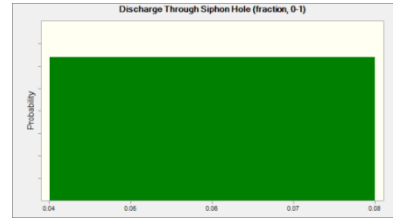

Assumption: Ethane

Cell: F6

Normal distribution with parameters:

Mean 5.513
Std. Dev. 0.043

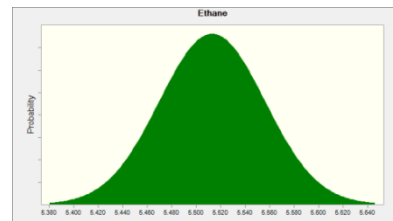

Assumption: Ethylbenzene

Cell: F19

Normal distribution with parameters:

Mean 0.196
Std. Dev. 0.018

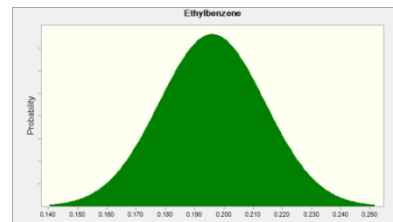

Assumption: Heptanes

Cell: F13

Normal distribution with parameters:

Mean 12.142
Std. Dev. 0.185

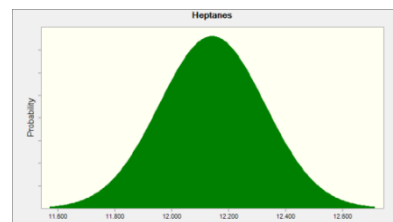

Assumption: Iso-Butane

Cell: F8

Normal distribution with parameters:

Mean 2.583
Std. Dev. 0.012

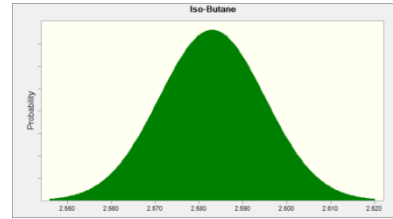

Assumption: Iso-Pentane

Cell: F10

Normal distribution with parameters:

Mean 5.667
Std. Dev. 0.067

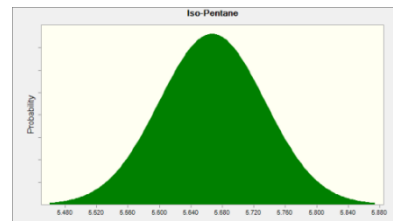

Assumption: m,p-Xylene (100% meta)

Cell: F20

Normal distribution with parameters:

Mean 2.319
Std. Dev. 0.030

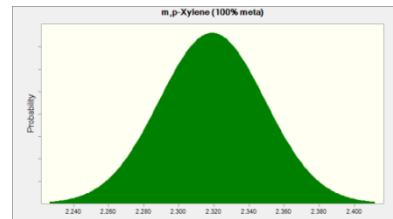

Assumption: Methane

Cell: F5

Normal distribution with parameters:

Mean 5.541
Std. Dev. 0.060

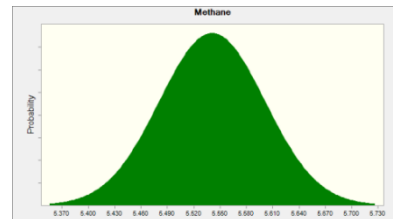

Assumption: n-Butane

Cell: F9

Normal distribution with parameters:

Mean

8.174

Std. Dev.

0.042

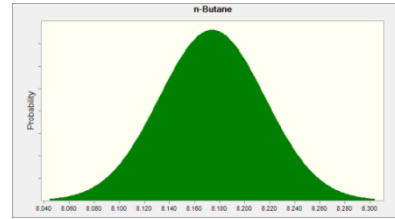

Assumption: n-Hexane

Cell: F12

Normal distribution with parameters:

Mean

6.090

Std. Dev.

0.132

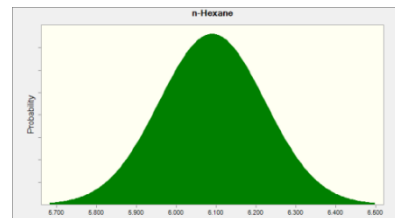

Assumption: Nonanes

Cell: F15

Normal distribution with parameters:

Mean

4.390

Std. Dev.

0.056

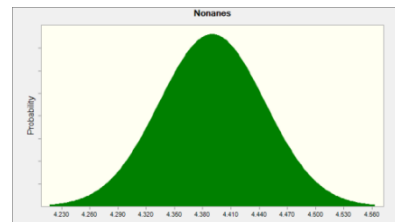

Assumption: n-Pentane

Cell: F11

Normal distribution with parameters:

Mean

7.902

Std. Dev.

0.033

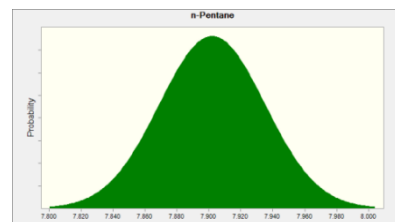

Assumption: Octanes

Cell: F14

Normal distribution with parameters:

Mean 9.578
Std. Dev. 0.313

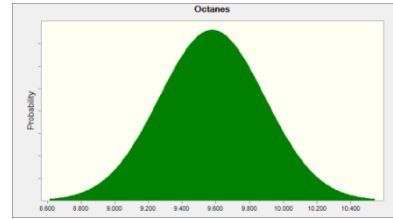

Assumption: o-Xylene

Cell: F21

Normal distribution with parameters:

Mean 0.520
Std. Dev. 0.007

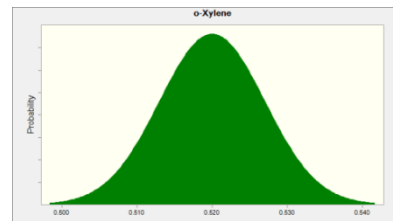

Assumption: Propane

Cell: F7

Normal distribution with parameters:

Mean 7.282
Std. Dev. 0.048

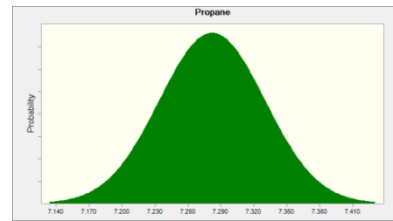

Assumption: Separator Pressure

Cell: S7

Uniform distribution with parameters:

Minimum 234.64
Maximum 244.42

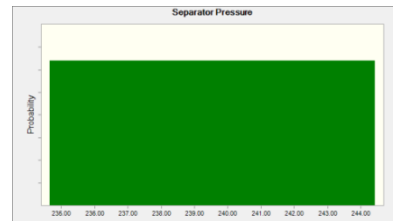

Assumption: Separator Temperature

Cell: S5

Uniform distribution with parameters:

Minimum 90.31
Maximum 94.29

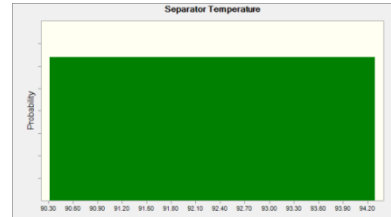

Assumption: Tank Bottom Pressure

Cell: S12

Normal distribution with parameters:

Mean 15.85
Std. Dev. 0.07

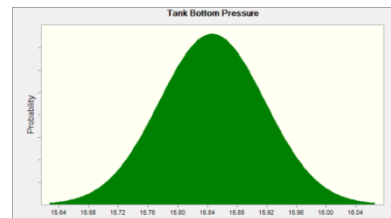

Assumption: Tank Bottom Temperature

Cell: S11

Uniform distribution with parameters:

Minimum 42.49
Maximum 45.51

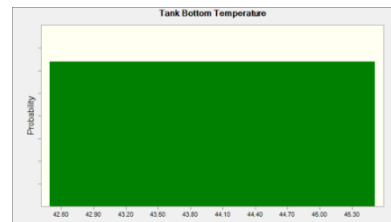

Assumption: Tank HS Pressure

Cell: S10

Uniform distribution with parameters:

Minimum 12.43
Maximum 12.67

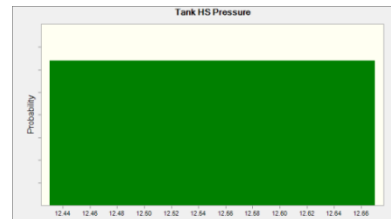

Assumption: Tank HS Temperature

Cell: S9

Uniform distribution with parameters:

Minimum

71.68

Maximum

75.72

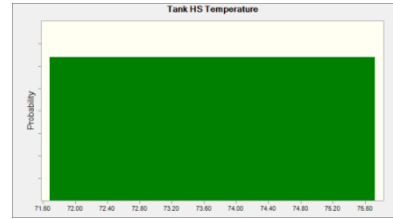

Assumption: Toluene

Cell: F18

Normal distribution with parameters:

Mean

2.816

Std. Dev.

0.031

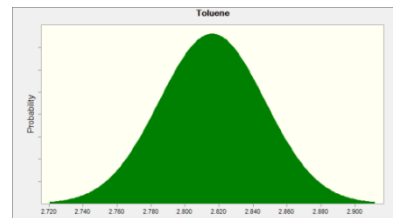

Assumption: Volume Flow (Std. Bbl)

Cell: F40

Normal distribution with parameters:

Mean

0.604

Std. Dev.

0.002

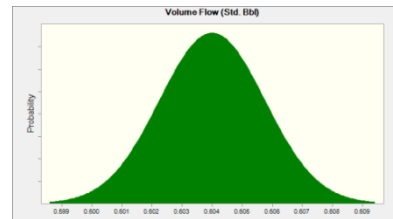

End of Assumptions

Winter PHLSA Study – MP2 – GPA 2186M

Crystal Ball Report - Full

Simulation started on 5/2/2017 at 8:01 PM
 Simulation stopped on 5/3/2017 at 2:19 PM

Run preferences:

Number of trials run	3,000
Monte Carlo	
Random seed	
Precision control on	
Confidence level	95.00%

Run statistics:

Total running time (sec)	65892.80
Trials/second (average)	0
Random numbers per sec	1

Crystal Ball data:

Assumptions	32
Correlations	0
Correlated groups	0
Decision variables	0
Forecasts	4

Forecasts

Worksheet: [Excel_HYSYS_PHLSA.xlsx]Input & Output

Forecast: Flash Gas to Oil Ratio (FGOR) - Standard (scf/bbl)

Cell: S34

Summary:

Entire range is from 193.794 to 218.769
 Base case is 206.248
 After 3,000 trials, the std. error of the mean is 0.064

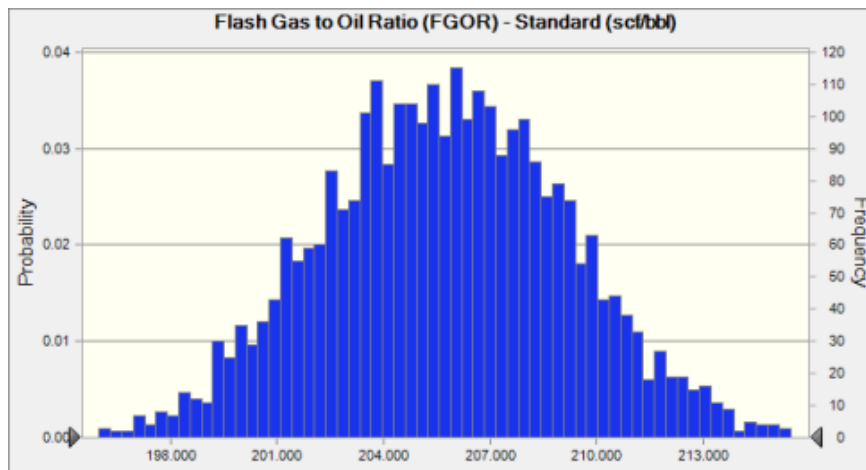

Statistics:	Forecast values
Trials	3,000
Base Case	206.248
Mean	205.725
Median	205.749
Mode	---
Standard Deviation	3.479
Variance	12.103
Skewness	0.0216
Kurtosis	2.88
Coeff. of Variability	0.0169
Minimum	193.794
Maximum	218.769
Range Width	24.976
Mean Std. Error	0.064

Forecast: Flash Gas to Oil Ratio (FGOR) - Standard (scf/bbl) (cont'd)**Cell: S34**

Percentiles:	Forecast values
0%	193.794
10%	201.227
20%	202.727
30%	203.824
40%	204.773
50%	205.744
60%	206.658
70%	207.654
80%	208.695
90%	210.143
100%	218.769

Forecast: Flash MW**Cell: S29**

Summary:

Entire range is from 36.147 to 37.344

Base case is 36.654

After 3,000 trials, the std. error of the mean is 0.004

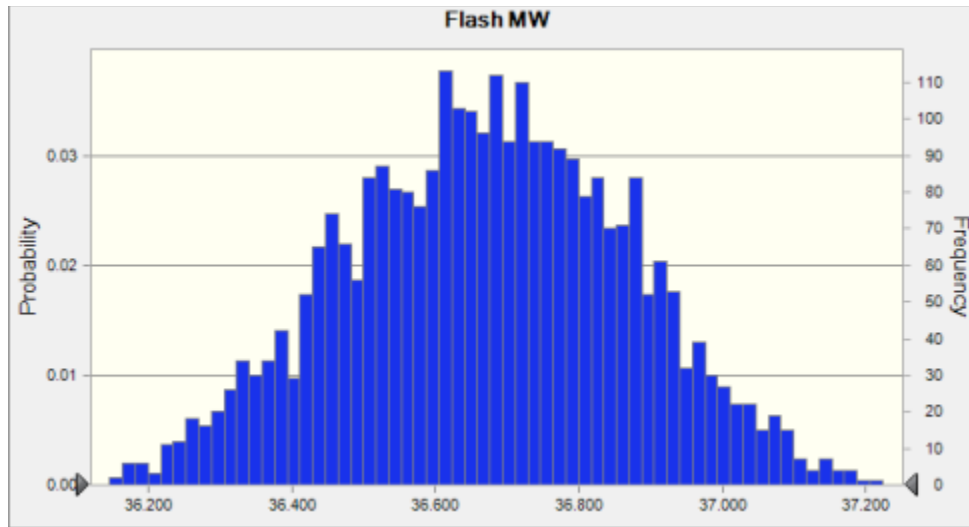

Statistics:	Forecast values
Trials	3,000
Base Case	36.654
Mean	36.671
Median	36.673
Mode	---
Standard Deviation	0.197
Variance	0.039
Skewness	-0.0089
Kurtosis	2.61
Coeff. of Variability	0.0054
Minimum	36.147
Maximum	37.344
Range Width	1.197
Mean Std. Error	0.004

Forecast: Flash MW (cont'd)

Cell: S29

Percentiles:	Forecast values
0%	36.147
10%	36.414
20%	36.499
30%	36.563
40%	36.622
50%	36.673
60%	36.724
70%	36.780
80%	36.847
90%	36.924
100%	37.344

Forecast: Sample Bubble Point at Tsep

Cell: S6

Summary:

Entire range is from 224.35 to 247.79

Base case is 236.70

After 3,000 trials, the std. error of the mean is 0.07

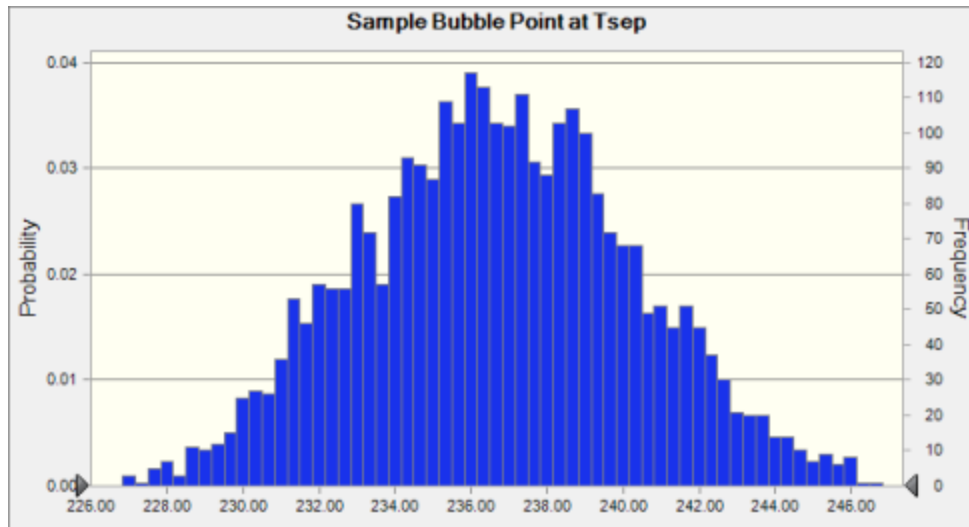

Statistics:	Forecast values
Trials	3,000
Base Case	236.70
Mean	236.65
Median	236.64
Mode	---
Standard Deviation	3.63
Variance	13.15
Skewness	0.0237
Kurtosis	2.79
Coeff. of Variability	0.0153
Minimum	224.35
Maximum	247.79
Range Width	23.44
Mean Std. Error	0.07

Forecast: Sample Bubble Point at Tsep (cont'd)

Cell: \$

Percentiles:	Forecast values
0%	224.35
10%	231.88
20%	233.46
30%	234.74
40%	235.72
50%	236.64
60%	237.56
70%	238.62
80%	239.73
90%	241.46
100%	247.79

Forecast: Shrinkage Factor

Cell: S

Summary:

Entire range is from 0.896 to 0.909

Base case is 0.902

After 3,000 trials, the std. error of the mean is 0.000

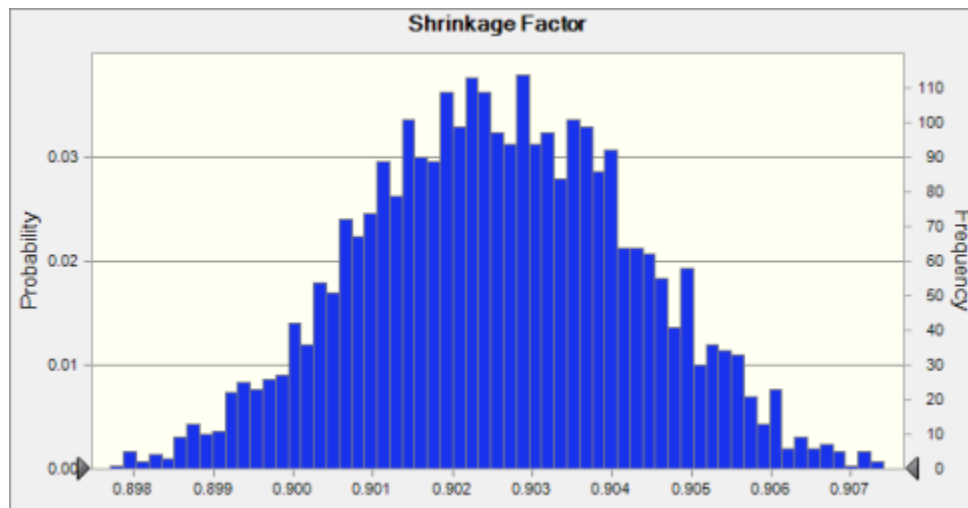

Statistics:	Forecast values
Trials	3,000
Base Case	0.902
Mean	0.903
Median	0.903
Mode	---
Standard Deviation	0.002
Variance	0.000
Skewness	-0.0146
Kurtosis	2.82
Coeff. of Variability	0.0019
Minimum	0.896
Maximum	0.909
Range Width	0.012
Mean Std. Error	0.000

Forecast: Shrinkage Factor (cont'd)

Cell: S37

Percentiles:	Forecast values
0%	0.896
10%	0.900
20%	0.901
30%	0.902
40%	0.902
50%	0.903
60%	0.903
70%	0.904
80%	0.904
90%	0.905
100%	0.909

End of Forecasts

Assumptions

Worksheet: [Excel_HYSYS_PHLA.xlsx]Input & Output

Assumption: 2,2,4-Trime thylpentane

Cell: F22

Normal distribution with parameters:	
Mean	0.046
Std. Dev.	0.000

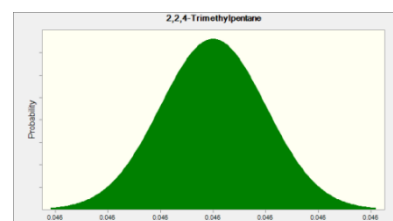

Assumption: 2,2-Dimethylbutane

Cell: F23

Normal distribution with parameters:

Mean

0.048

Std. Dev.

0.000

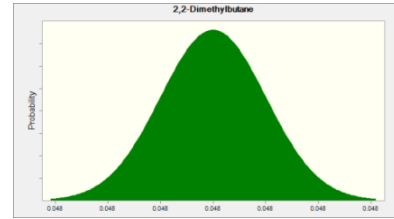

Assumption: 2,3-Dimethylbutane

Cell: F24

Normal distribution with parameters:

Mean

0.162

Std. Dev.

0.000

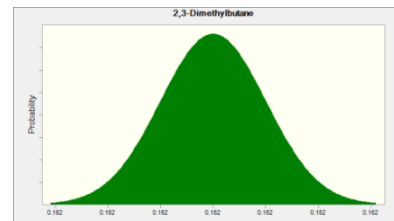

Assumption: 2-Methylpentane

Cell: F26

Normal distribution with parameters:

Mean

1.151

Std. Dev.

0.002

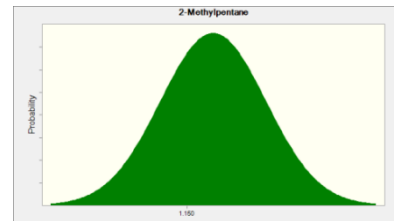

Assumption: 3-Methylpentane

Cell: F27

Normal distribution with parameters:

Mean

0.653

Std. Dev.

0.001

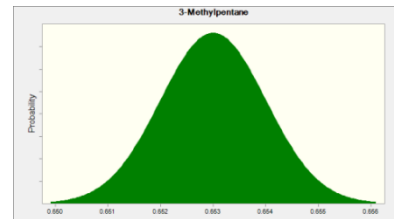

Assumption: Benzene

Cell: F17

Normal distribution with parameters:

Mean 0.274
Std. Dev. 0.005

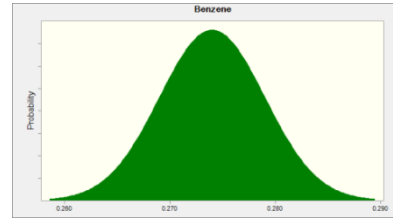

Assumption: Carbon Dioxide

Cell: F3

Normal distribution with parameters:

Mean 0.408
Std. Dev. 0.012

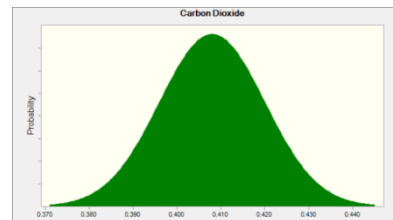

Assumption: Cyclopentane

Cell: F25

Normal distribution with parameters:

Mean 0.200
Std. Dev. 0.000

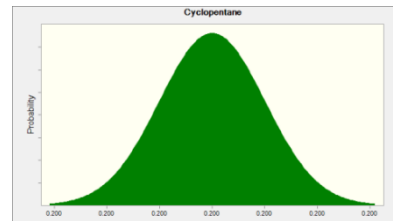

Assumption: Decanes Plus

Cell: F16

Normal distribution with parameters:

Mean 28.996
Std. Dev. 0.459

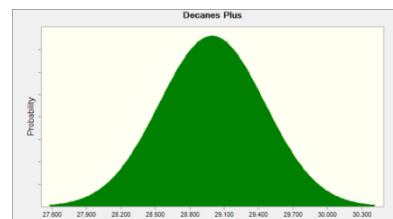

Assumption: Discharge Through Siphon Hole (fraction, 0-1)

Cell: S8

Uniform distribution with parameters:

Minimum 0.04
Maximum 0.08

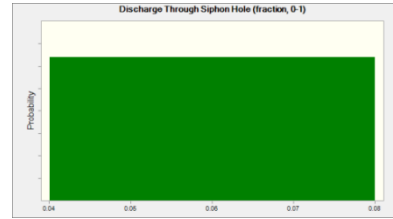

Assumption: Ethane

Cell: F6

Normal distribution with parameters:

Mean 5.565
Std. Dev. 0.039

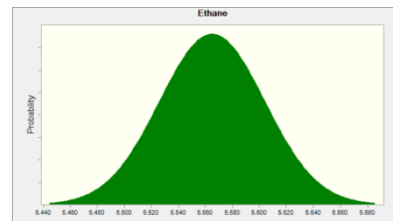

Assumption: Ethylbenzene

Cell: F19

Normal distribution with parameters:

Mean 0.102
Std. Dev. 0.008

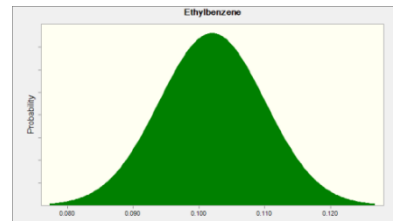

Assumption: Heptanes

Cell: F13

Normal distribution with parameters:

Mean 9.875
Std. Dev. 0.056

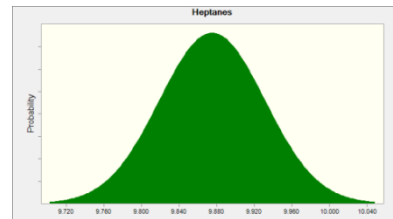

Assumption: Iso-Butane

Cell: F8

Normal distribution with parameters:

Mean 2.576
Std. Dev. 0.014

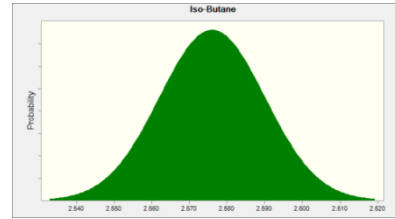

Assumption: Iso-Pentane

Cell: F10

Normal distribution with parameters:

Mean 5.606
Std. Dev. 0.096

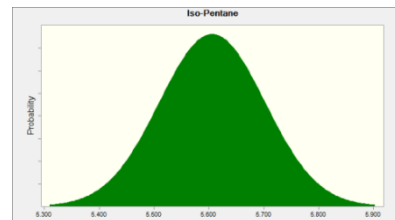

Assumption: m,p-Xylene (100% meta)

Cell: F20

Normal distribution with parameters:

Mean 1.108
Std. Dev. 0.007

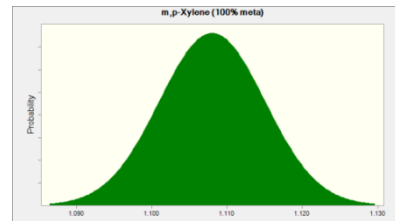

Assumption: Methane

Cell: F5

Normal distribution with parameters:

Mean 5.725
Std. Dev. 0.103

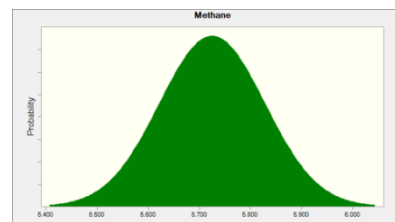

Assumption: n-Butane

Cell: F9

Normal distribution with parameters:

Mean

8.326

Std. Dev.

0.033

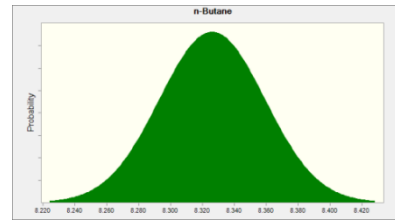

Assumption: n-Hexane

Cell: F12

Normal distribution with parameters:

Mean

1.940

Std. Dev.

0.008

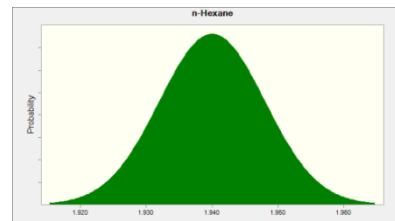

Assumption: Nonanes

Cell: F15

Normal distribution with parameters:

Mean

3.023

Std. Dev.

0.046

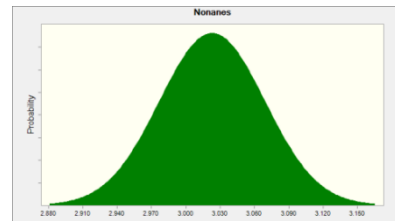

Assumption: n-Pentane

Cell: F11

Normal distribution with parameters:

Mean

7.823

Std. Dev.

0.029

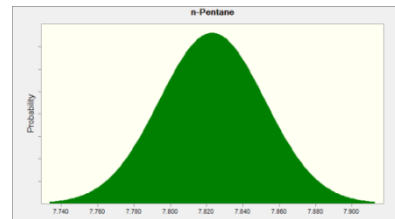

Assumption: Octanes

Cell: F14

Normal distribution with parameters:

Mean

7.763

Std. Dev.

0.160

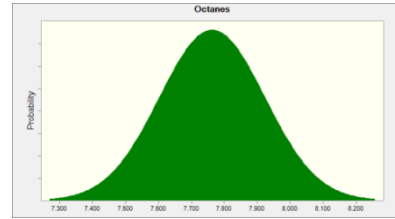

Assumption: o-Xylene

Cell: F21

Normal distribution with parameters:

Mean

0.238

Std. Dev.

0.002

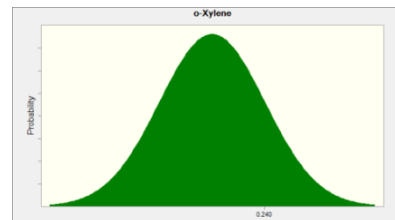

Assumption: Propane

Cell: F7

Normal distribution with parameters:

Mean

7.228

Std. Dev.

0.058

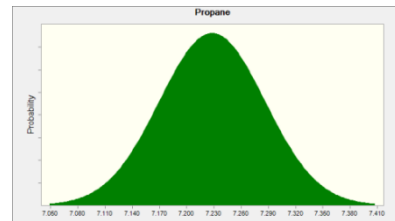

Assumption: Separator Pressure

Cell: S7

Uniform distribution with parameters:

Minimum

234.64

Maximum

244.42

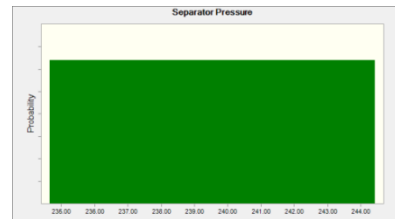

Assumption: Separator Temperature

Cell: S5

Uniform distribution with parameters:

Minimum 90.31
Maximum 94.29

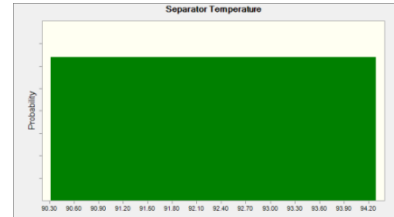

Assumption: Tank Bottom Pressure

Cell: S12

Normal distribution with parameters:

Mean 15.85
Std. Dev. 0.07

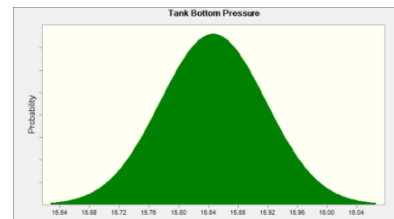

Assumption: Tank Bottom Temperature

Cell: S11

Uniform distribution with parameters:

Minimum 42.50
Maximum 45.50

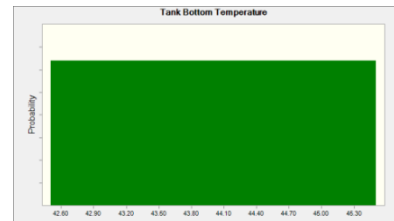

Assumption: Tank HS Pressure

Cell: S10

Uniform distribution with parameters:

Minimum 12.43
Maximum 12.67

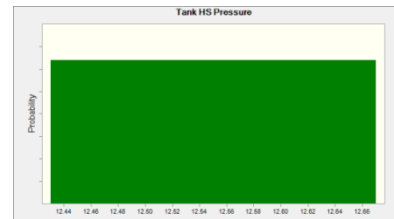

Assumption: Tank HS Temperature

Cell: S9

Uniform distribution with parameters:

Minimum

71.67

Maximum

75.73

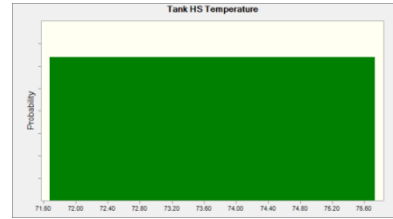

Assumption: Toluene

Cell: F18

Normal distribution with parameters:

Mean

1.164

Std. Dev.

0.007

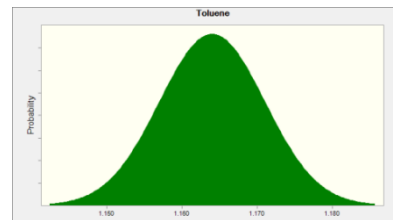

Assumption: Volume Flow (Std. Bbl)

Cell: F40

Normal distribution with parameters:

Mean

0.604

Std. Dev.

0.002

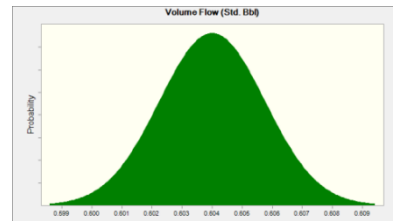

End of Assumptions

Winter PHLSA Study – LP1 – GPA 2103M

Crystal Ball Report - Full

Simulation started on 5/7/2017 at 12:54 PM

Simulation stopped on 5/8/2017 at 8:38 AM

Run preferences:

Number of trials run	3,000
Monte Carlo	
Random seed	
Precision control on	
Confidence level	95.00%

Run statistics:

Total running time (sec)	71062.27
Trials/second (average)	0
Random numbers per sec	1

Crystal Ball data:

Assumptions	32
Correlations	0
Correlated groups	0
Decision variables	0
Forecasts	4

Forecasts

Worksheet: [Excel_HYSYS_PHLSA.xlsx]Input & Output

Forecast: Flash Gas to Oil Ratio (FGOR) - Standard (scf/bbl)

Cell: S34

Summary:

Entire range is from 143.570 to 162.012

Base case is 152.629

After 3,000 trials, the std. error of the mean is 0.048

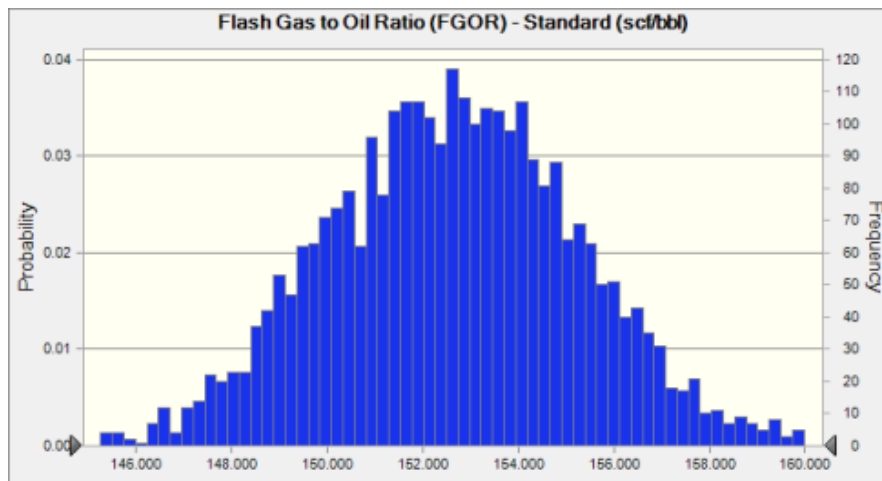

Statistics:	Forecast values
Trials	3,000
Base Case	152.629
Mean	152.618
Median	152.620
Mode	150.102
Standard Deviation	2.628
Variance	6.907
Skewness	0.0208
Kurtosis	2.88
Coeff. of Variability	0.0172
Minimum	143.570
Maximum	162.012
Range Width	18.442
Mean Std. Error	0.048

Forecast: Flash Gas to Oil Ratio (FGOR) - Standard (scf/bbl) (cont'd)**Cell: S34**

Percentiles:	Forecast values
0%	143.570
10%	149.215
20%	150.319
30%	151.241
40%	151.929
50%	152.617
60%	153.298
70%	154.024
80%	154.827
90%	155.983
100%	162.012

Forecast: Flash MW**Cell: S29****Summary:**

Entire range is from 36.795 to 38.144

Base case is 37.480

After 3,000 trials, the std. error of the mean is 0.005

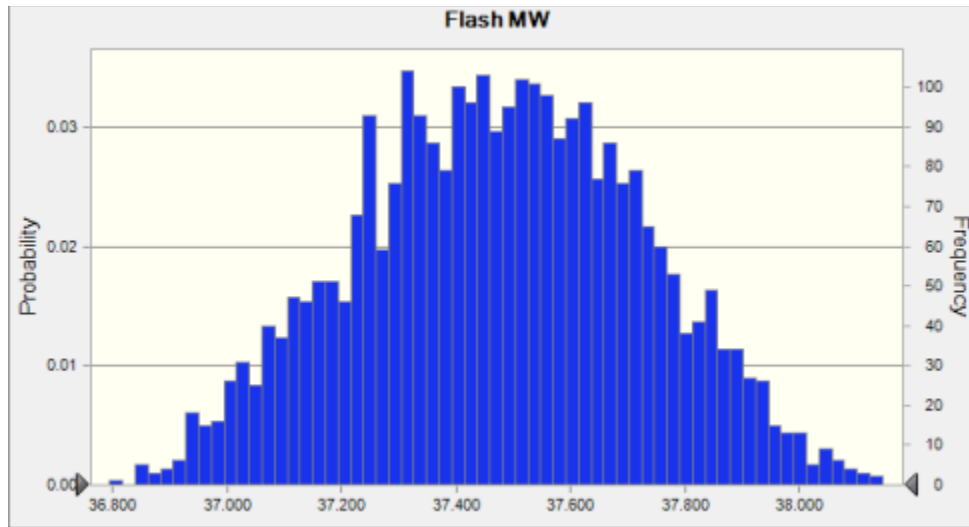

Statistics:	Forecast values
Trials	3,000
Base Case	37.480
Mean	37.475
Median	37.477
Mode	37.064
Standard Deviation	0.248
Variance	0.061
Skewness	-0.0170
Kurtosis	2.49
Coeff. of Variability	0.0066
Minimum	36.795
Maximum	38.144
Range Width	1.349
Mean Std. Error	0.005

Forecast: Flash MW (cont'd)

Cell: S29

Percentiles:	Forecast values
0%	36.795
10%	37.140
20%	37.254
30%	37.334
40%	37.410
50%	37.477
60%	37.544
70%	37.615
80%	37.696
90%	37.800
100%	38.144

Forecast: Sample Bubble Point at Tsep

Cell: S6

Summary:

Entire range is from 174.05 to 187.07

Base case is 180.37

After 3,000 trials, the std. error of the mean is 0.04

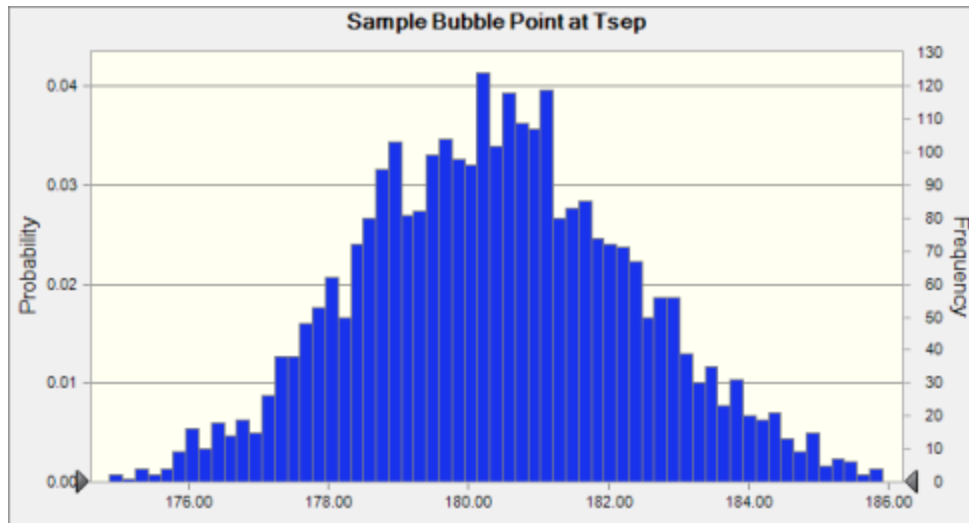

Statistics:

Forecast values

Trials	3,000
Base Case	180.37
Mean	180.39
Median	180.35
Mode	181.59
Standard Deviation	1.97
Variance	3.88
Skewness	0.1081
Kurtosis	2.83
Coeff. of Variability	0.0109
Minimum	174.05
Maximum	187.07
Range Width	13.02
Mean Std. Error	0.04

Forecast: Sample Bubble Point at Tsep (cont'd)

Cell: S6

Percentiles:	Forecast values
0%	174.05
10%	177.87
20%	178.70
30%	179.30
40%	179.87
50%	180.35
60%	180.85
70%	181.39
80%	182.07
90%	182.95
100%	187.07

Forecast: Shrinkage Factor

Cell: S37

Summary:

Entire range is from 0.920 to 0.930
 Base case is 0.925
 After 3,000 trials, the std. error of the mean is 0.000

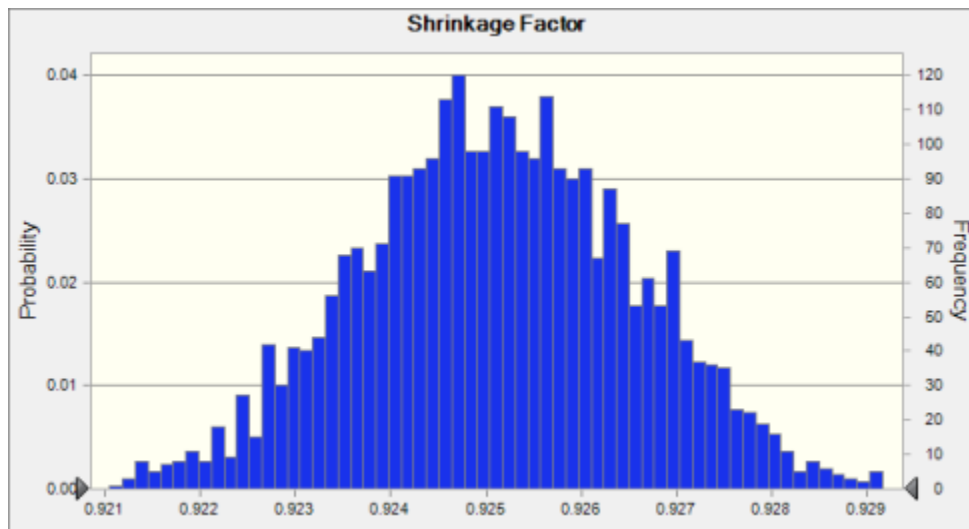

Statistics:	Forecast values
Trials	3,000
Base Case	0.925
Mean	0.925
Median	0.925
Mode	0.927
Standard Deviation	0.001
Variance	0.000
Skewness	-0.0206
Kurtosis	2.83
Coeff. of Variability	0.0016
Minimum	0.920
Maximum	0.930
Range Width	0.010
Mean Std. Error	0.000

Forecast: Shrinkage Factor (cont'd)

Cell: S37

Percentiles:	Forecast values
0%	0.920
10%	0.923
20%	0.924
30%	0.924
40%	0.925
50%	0.925
60%	0.925
70%	0.926
80%	0.926
90%	0.927
100%	0.930

End of Forecasts

Assumptions

Worksheet: [Excel_HYSYS_PHLA.xlsx]Input & Output

Assumption: 2,2,4-Trime thylpentane

Cell: F22

Normal distribution with parameters:	
Mean	0.042
Std. Dev.	0.000

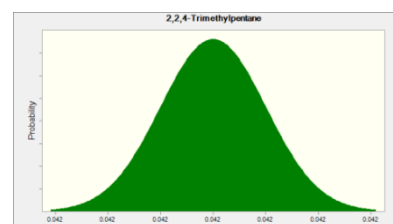

Assumption: 2,2-Dimethylbutane

Cell: F23

Normal distribution with parameters:

Mean

0.102

Std. Dev.

0.000

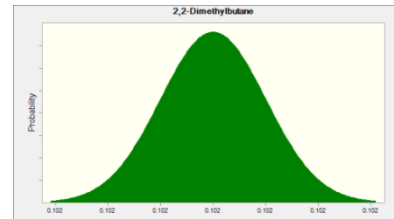

Assumption: 2,3-Dimethylbutane

Cell: F24

Normal distribution with parameters:

Mean

0.349

Std. Dev.

0.001

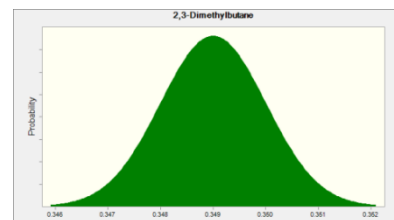

Assumption: 2-Methylpentane

Cell: F26

Normal distribution with parameters:

Mean

3.287

Std. Dev.

0.008

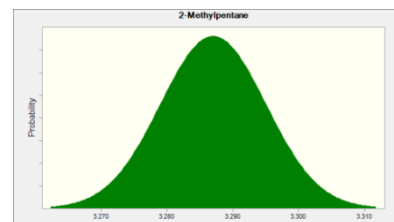

Assumption: 3-Methylpentane

Cell: F27

Normal distribution with parameters:

Mean

2.049

Std. Dev.

0.005

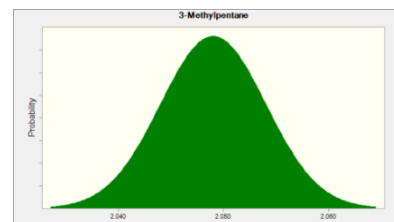

Assumption: Benzene

Cell: F17

Normal distribution with parameters:

Mean 0.894
Std. Dev. 0.024

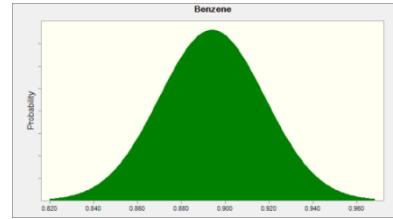

Assumption: Carbon Dioxide

Cell: F3

Normal distribution with parameters:

Mean 0.290
Std. Dev. 0.002

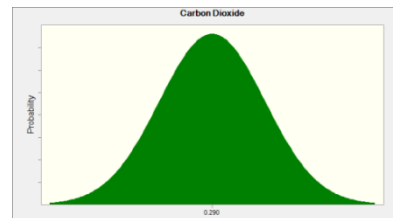

Assumption: Cyclopentane

Cell: F25

Normal distribution with parameters:

Mean 0.429
Std. Dev. 0.001

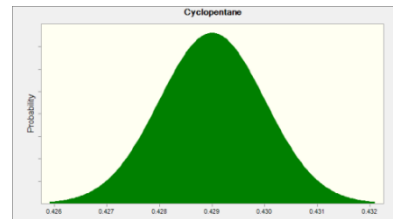

Assumption: Decanes Plus

Cell: F16

Normal distribution with parameters:

Mean 13.699
Std. Dev. 0.176

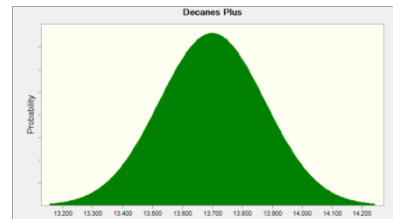

Assumption: Discharge Through Siphon Hole (fraction, 0-1)

Cell: S8

Uniform distribution with parameters:

Minimum 0.04
Maximum 0.08

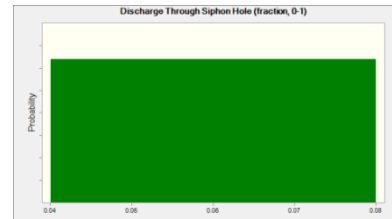

Assumption: Ethane

Cell: F6

Normal distribution with parameters:

Mean 4.620
Std. Dev. 0.036

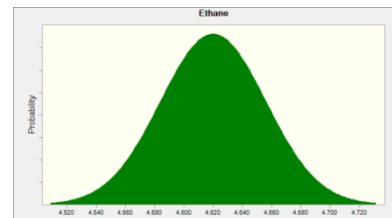

Assumption: Ethylbenzene

Cell: F19

Normal distribution with parameters:

Mean 0.206
Std. Dev. 0.019

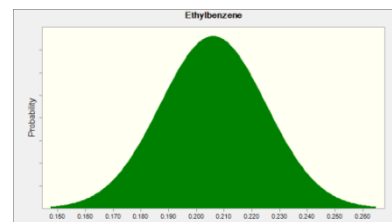

Assumption: Heptanes

Cell: F13

Normal distribution with parameters:

Mean 13.189
Std. Dev. 0.201

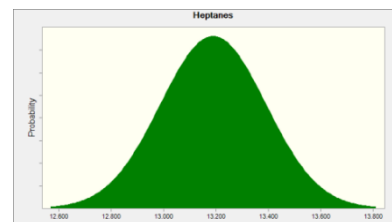

Assumption: Iso-Butane

Cell: F8

Normal distribution with parameters:

Mean 2.382
Std. Dev. 0.011

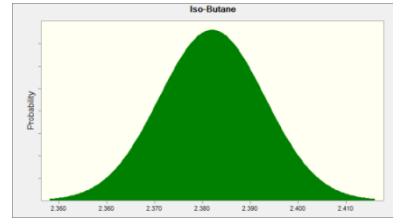

Assumption: Iso-Pentane

Cell: F10

Normal distribution with parameters:

Mean 5.186
Std. Dev. 0.061

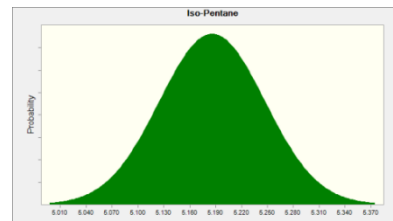

Assumption: m,p-Xylene (100% meta)

Cell: F20

Normal distribution with parameters:

Mean 2.446
Std. Dev. 0.032

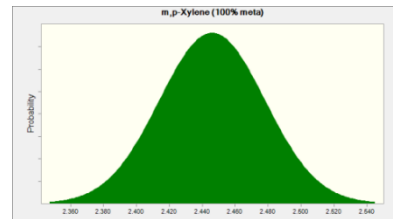

Assumption: Methane

Cell: F5

Normal distribution with parameters:

Mean 4.266
Std. Dev. 0.046

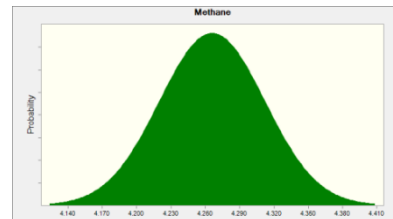

Assumption: n-Butane

Cell: F9

Normal distribution with parameters:

Mean

7.531

Std. Dev.

0.039

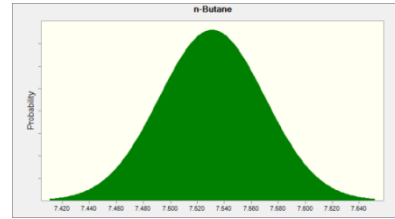

Assumption: n-Hexane

Cell: F12

Normal distribution with parameters:

Mean

6.587

Std. Dev.

0.143

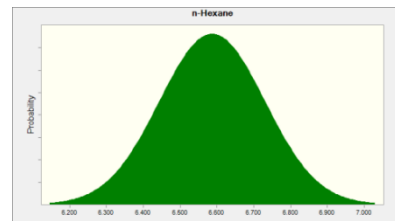

Assumption: Nonanes

Cell: F15

Normal distribution with parameters:

Mean

4.661

Std. Dev.

0.060

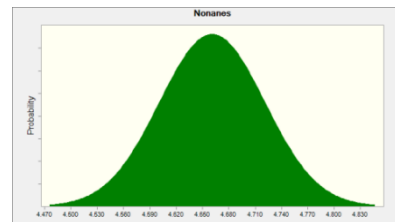

Assumption: n-Pentane

Cell: F11

Normal distribution with parameters:

Mean

7.331

Std. Dev.

0.030

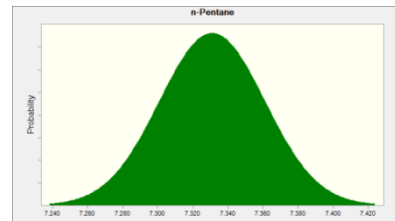

Assumption: Octanes

Cell: F14

Normal distribution with parameters:

Mean 10.222
Std. Dev. 0.334

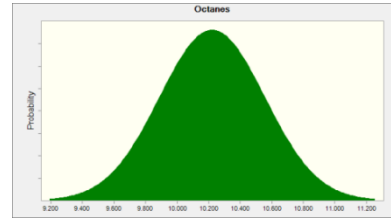

Assumption: o-Xylene

Cell: F21

Normal distribution with parameters:

Mean 0.548
Std. Dev. 0.007

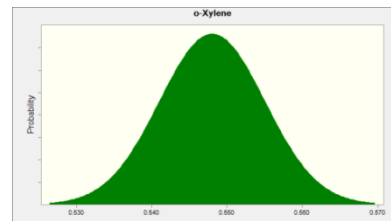

Assumption: Propane

Cell: F7

Normal distribution with parameters:

Mean 6.614
Std. Dev. 0.044

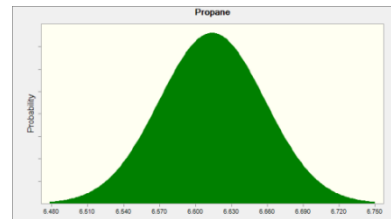

Assumption: Separator Pressure

Cell: S7

Uniform distribution with parameters:

Minimum 186.69
Maximum 194.57

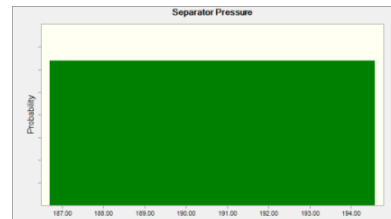

Assumption: Separator Temperature

Cell: S5

Uniform distribution with parameters:

Minimum 85.41
Maximum 89.39

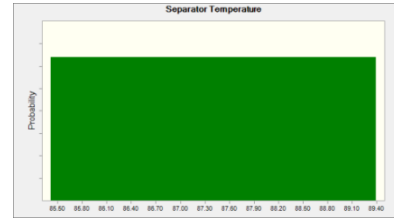

Assumption: Tank Bottom Pressure

Cell: S12

Normal distribution with parameters:

Mean 15.89
Std. Dev. 0.07

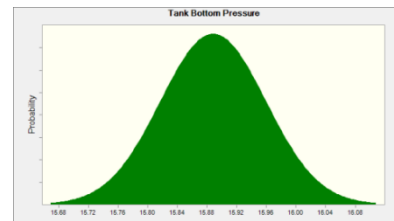

Assumption: Tank Bottom Temperature

Cell: S11

Uniform distribution with parameters:

Minimum 43.49
Maximum 46.51

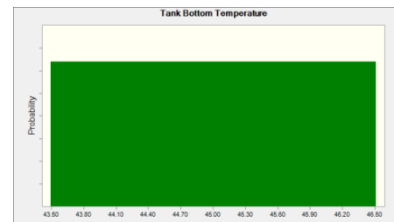

Assumption: Tank HS Pressure

Cell: S10

Uniform distribution with parameters:

Minimum 12.43
Maximum 12.67

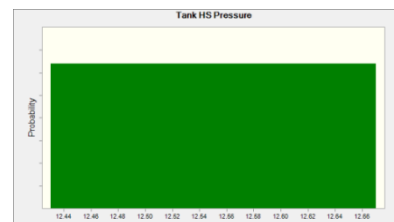

Assumption: Tank HS Temperature

Cell: S9

Uniform distribution with parameters:

Minimum
Maximum

83.48
87.52

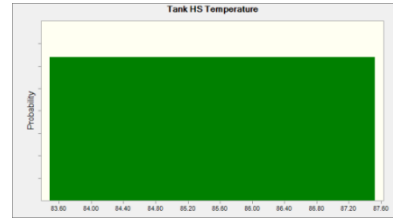

Assumption: Toluene

Cell: F18

Normal distribution with parameters:

Mean
Std. Dev.

3.070
0.034

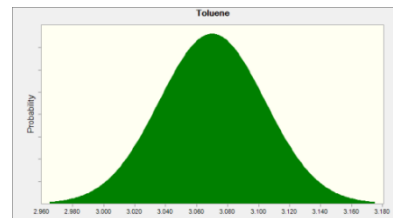

Assumption: Volume Flow (Std. Bbl)

Cell: F40

Normal distribution with parameters:

Mean
Std. Dev.

0.642
0.002

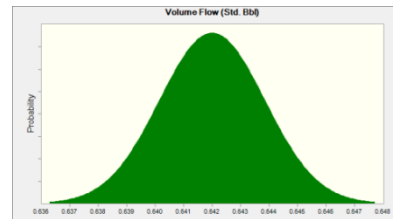

End of Assumptions

Winter PHLSA Study – LP1 – GPA 2186M

Crystal Ball Report - Full

Simulation started on 5/6/2017 at 11:34 AM
 Simulation stopped on 5/7/2017 at 10:02 AM

Run preferences:

Number of trials run	3,000
Monte Carlo	
Random seed	
Precision control on	
Confidence level	95.00%

Run statistics:

Total running time (sec)	80840.07
Trials/second (average)	0
Random numbers per sec	1

Crystal Ball data:

Assumptions	32
Correlations	0
Correlated groups	0
Decision variables	0
Forecasts	4

Forecasts

Worksheet: [Excel_HYSYS_PHLSA.xlsx]Input & Output

Forecast: Flash Gas to Oil Ratio (FGOR) - Standard (scf/bbl)

Cell: S34

Summary:

Entire range is from 140.537 to 158.657
 Base case is 149.438
 After 3,000 trials, the std. error of the mean is 0.053

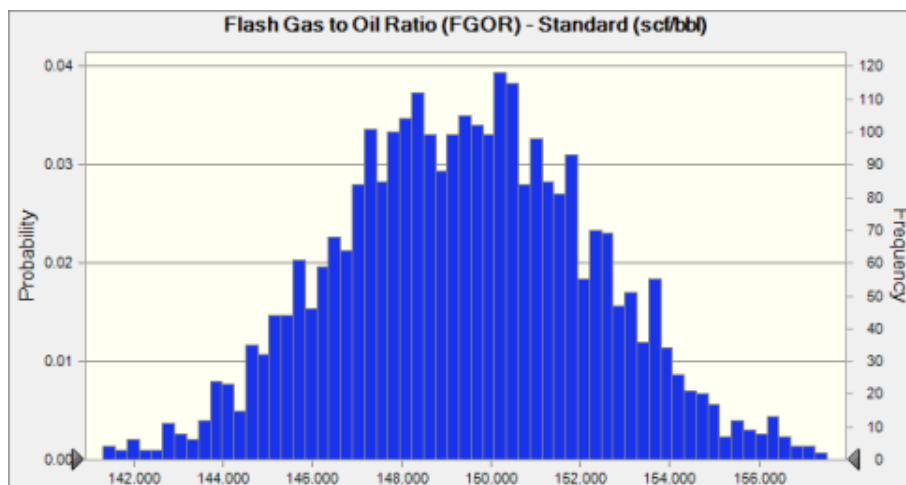

Statistics:	Forecast values
Trials	3,000
Base Case	149.438
Mean	149.414
Median	149.389
Mode	151.084
Standard Deviation	2.892
Variance	8.362
Skewness	0.0374
Kurtosis	2.83
Coeff. of Variability	0.0194
Minimum	140.537
Maximum	158.657
Range Width	18.120
Mean Std. Error	0.053

Forecast: Flash Gas to Oil Ratio (FGOR) - Standard (scf/bbl) (cont'd)**Cell: S34**

Percentiles:	Forecast values
0%	140.537
10%	145.665
20%	146.963
30%	147.817
40%	148.579
50%	149.389
60%	150.182
70%	150.974
80%	151.858
90%	153.182
100%	158.657

Forecast: Flash MW**Cell: S29**

Summary:

Entire range is from 36.186 to 37.521

Base case is 36.843

After 3,000 trials, the std. error of the mean is 0.004

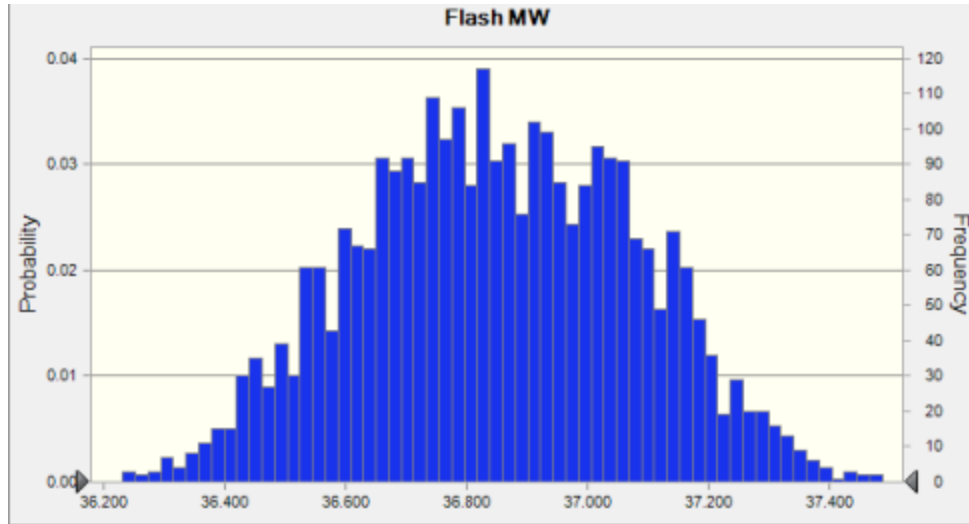

Statistics:	Forecast values
Trials	3,000
Base Case	36.843
Mean	36.849
Median	36.844
Mode	37.026
Standard Deviation	0.228
Variance	0.052
Skewness	-0.0167
Kurtosis	2.51
Coeff. of Variability	0.0062
Minimum	36.186
Maximum	37.521
Range Width	1.336
Mean Std. Error	0.004

Forecast: Flash MW (cont'd)

Cell: S29

Percentiles:	Forecast values
0%	36.186
10%	36.548
20%	36.650
30%	36.719
40%	36.782
50%	36.844
60%	36.916
70%	36.985
80%	37.055
90%	37.146
100%	37.521

Forecast: Sample Bubble Point at Tsep

Cell: S6

Summary:

Entire range is from 169.14 to 187.97

Base case is 178.43

After 3,000 trials, the std. error of the mean is 0.05

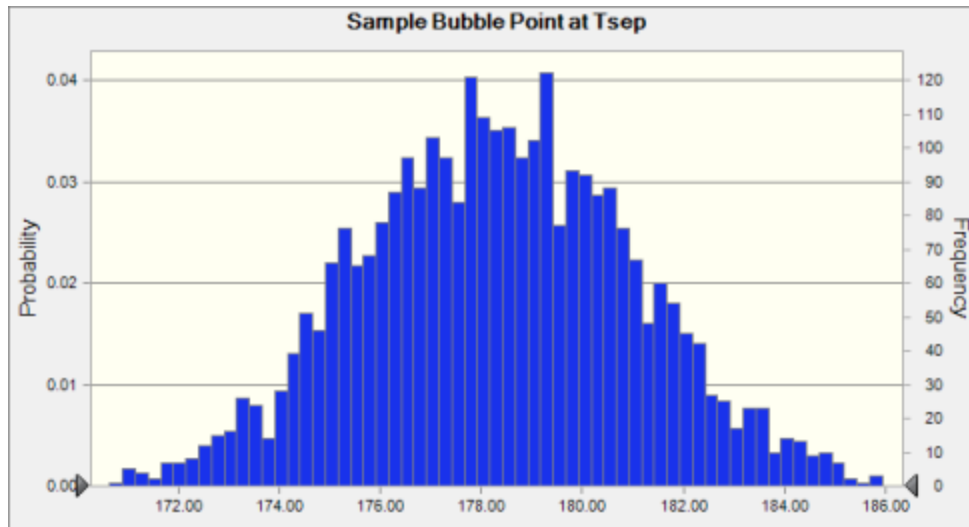

Statistics:

Forecast values

Trials	3,000
Base Case	178.43
Mean	178.29
Median	178.25
Mode	179.91
Standard Deviation	2.73
Variance	7.46
Skewness	0.0027
Kurtosis	2.90
Coeff. of Variability	0.0153
Minimum	169.14
Maximum	187.97
Range Width	18.83
Mean Std. Error	0.05

Forecast: Sample Bubble Point at Tsep (cont'd)

Cell: \$

Percentiles:	Forecast values
0%	169.14
10%	174.82
20%	175.94
30%	176.79
40%	177.60
50%	178.25
60%	179.00
70%	179.78
80%	180.62
90%	181.78
100%	187.97

Forecast: Shrinkage Factor

Cell: S

Summary:

Entire range is from 0.923 to 0.932

Base case is 0.928

After 3,000 trials, the std. error of the mean is 0.000

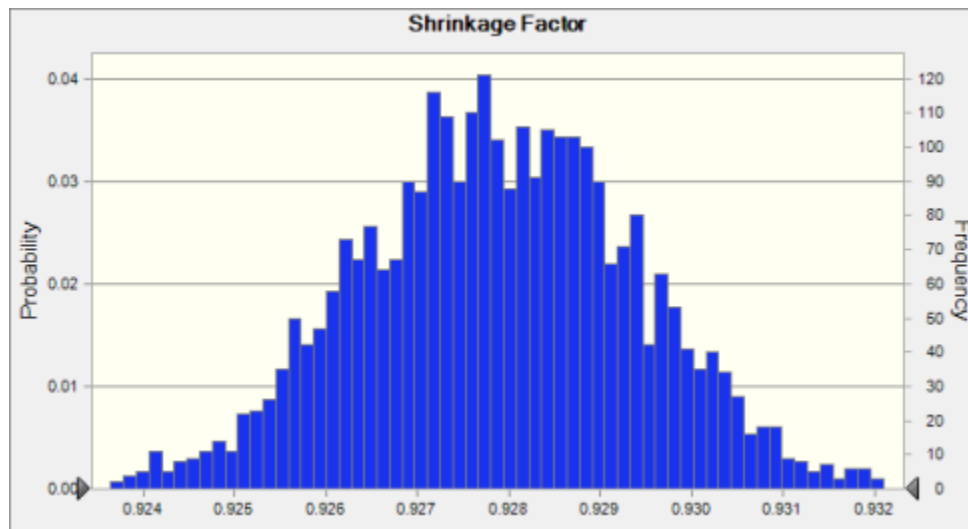

Statistics:	Forecast values
Trials	3,000
Base Case	0.928
Mean	0.928
Median	0.928
Mode	0.927
Standard Deviation	0.002
Variance	0.000
Skewness	-0.0278
Kurtosis	2.79
Coeff. of Variability	0.0016
Minimum	0.923
Maximum	0.932
Range Width	0.009
Mean Std. Error	0.000

Forecast: Shrinkage Factor (cont'd)

Cell: S37

Percentiles:	Forecast values
0%	0.923
10%	0.926
20%	0.927
30%	0.927
40%	0.927
50%	0.928
60%	0.928
70%	0.929
80%	0.929
90%	0.930
100%	0.932

End of Forecasts

Assumptions

Worksheet: [Excel_HYSYS_PHLA.xlsx]Input & Output

Assumption: 2,2,4-Trime thylpenta ne

Cell: F22

Normal distribution with parameters:	
Mean	0.048
Std. Dev.	0.000

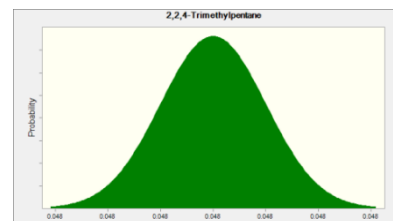

Assumption: 2,2-Dimethylbutane

Cell: F23

Normal distribution with parameters:

Mean

0.047

Std. Dev.

0.000

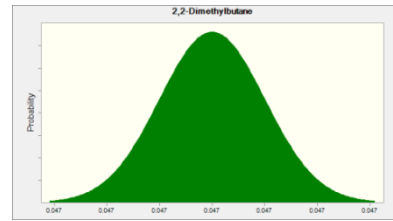

Assumption: 2,3-Dimethylbutane

Cell: F24

Normal distribution with parameters:

Mean

0.165

Std. Dev.

0.000

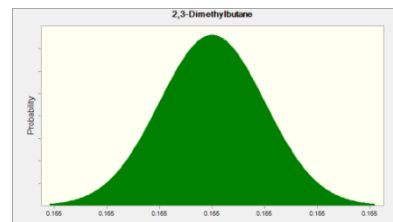

Assumption: 2-Methylpentane

Cell: F26

Normal distribution with parameters:

Mean

1.195

Std. Dev.

0.002

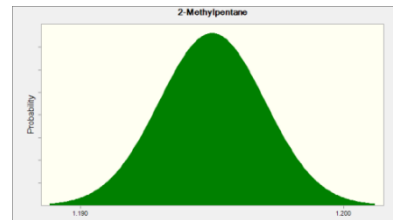

Assumption: 3-Methylpentane

Cell: F27

Normal distribution with parameters:

Mean

0.685

Std. Dev.

0.001

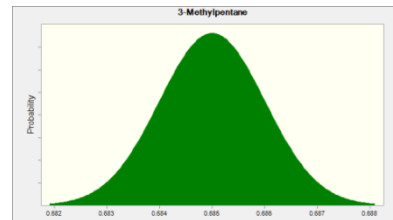

Assumption: Benzene

Cell: F17

Normal distribution with parameters:

Mean

0.297

Std. Dev.

0.005

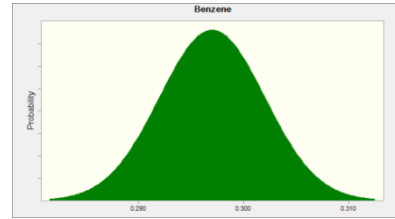

Assumption: Carbon Dioxide

Cell: F3

Normal distribution with parameters:

Mean

0.370

Std. Dev.

0.011

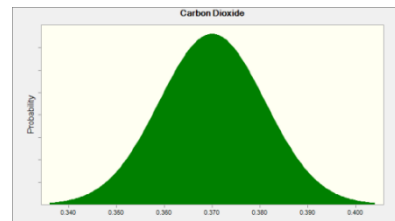

Assumption: Cyclopentane

Cell: F25

Normal distribution with parameters:

Mean

0.203

Std. Dev.

0.000

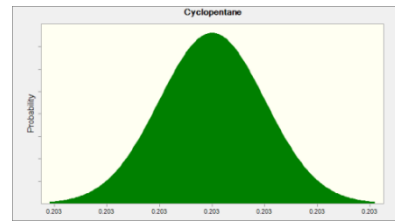

Assumption: Decanes Plus

Cell: F16

Normal distribution with parameters:

Mean

32.238

Std. Dev.

0.510

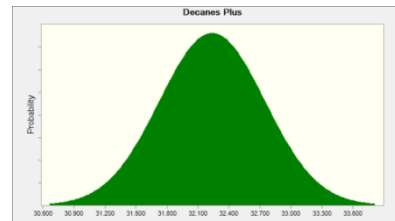

Assumption: Discharge Through Siphon Hole (fraction, 0-1)

Cell: S8

Uniform distribution with parameters:

Minimum 0.04
Maximum 0.08

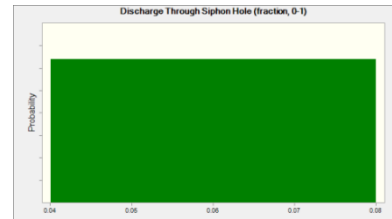

Assumption: Ethane

Cell: F6

Normal distribution with parameters:

Mean 4.688
Std. Dev. 0.033

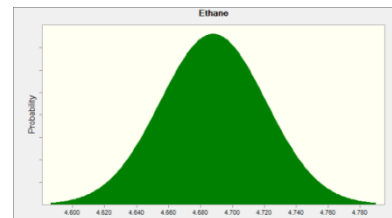

Assumption: Ethylbenzene

Cell: F19

Normal distribution with parameters:

Mean 0.112
Std. Dev. 0.008

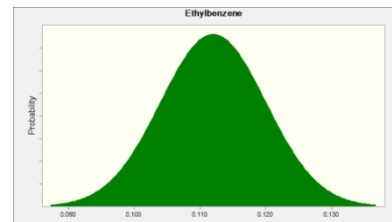

Assumption: Heptanes

Cell: F13

Normal distribution with parameters:

Mean 10.472
Std. Dev. 0.059

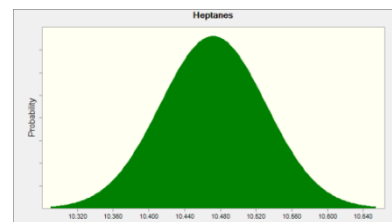

Assumption: Iso-Butane

Cell: F8

Normal distribution with parameters:

Mean

2.397

Std. Dev.

0.013

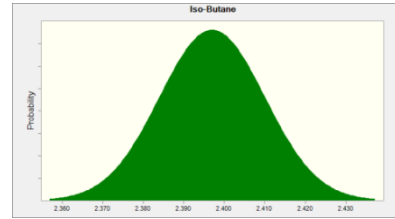

Assumption: Iso-Pentane

Cell: F10

Normal distribution with parameters:

Mean

5.161

Std. Dev.

0.089

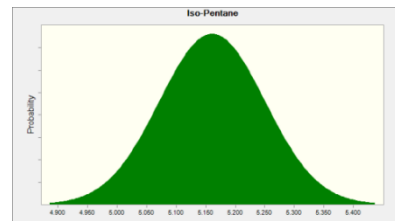

Assumption: m,p-Xylene (100% meta)

Cell: F20

Normal distribution with parameters:

Mean

1.205

Std. Dev.

0.008

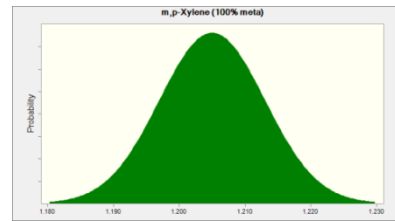

Assumption: Methane

Cell: F5

Normal distribution with parameters:

Mean

4.266

Std. Dev.

0.077

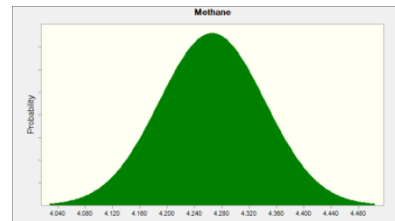

Assumption: n-Butane

Cell: F9

Normal distribution with parameters:

Mean

7.660

Std. Dev.

0.030

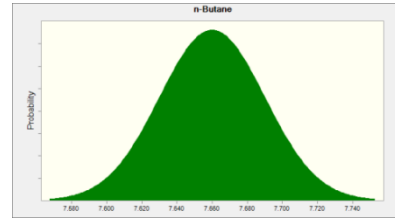

Assumption: n-Hexane

Cell: F12

Normal distribution with parameters:

Mean

2.081

Std. Dev.

0.009

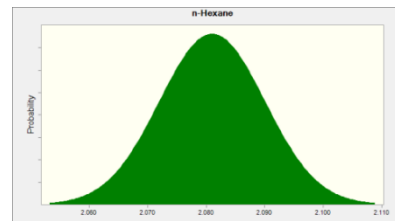

Assumption: Nonanes

Cell: F15

Normal distribution with parameters:

Mean

3.092

Std. Dev.

0.047

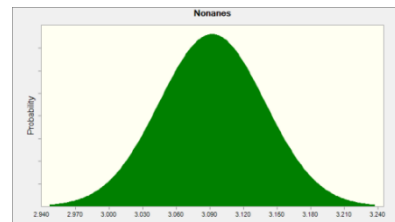

Assumption: n-Pentane

Cell: F11

Normal distribution with parameters:

Mean

7.270

Std. Dev.

0.027

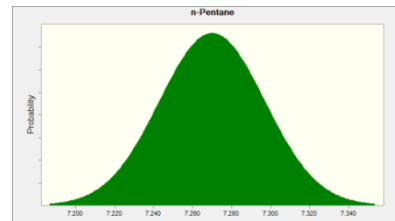

Assumption: Octanes

Cell: F14

Normal distribution with parameters:

Mean 8.203
Std. Dev. 0.169

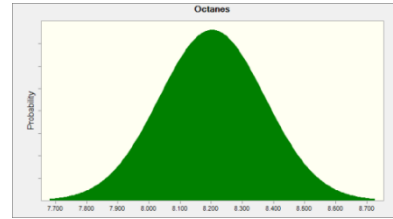

Assumption: o-Xylene

Cell: F21

Normal distribution with parameters:

Mean 0.242
Std. Dev. 0.002

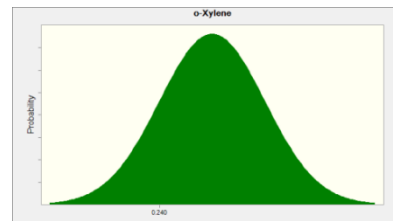

Assumption: Propane

Cell: F7

Normal distribution with parameters:

Mean 6.586
Std. Dev. 0.053

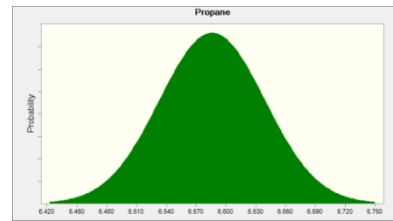

Assumption: Separator Pressure

Cell: S7

Uniform distribution with parameters:

Minimum 186.69
Maximum 194.57

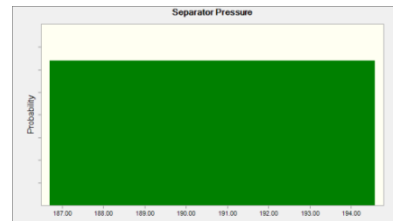

Assumption: Separator Temperature

Cell: S5

Uniform distribution with parameters:

Minimum 85.41
Maximum 89.39

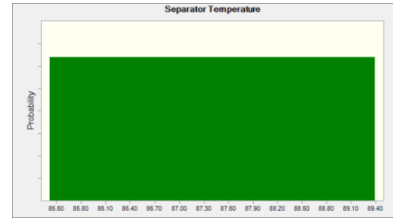

Assumption: Tank Bottom Pressure

Cell: S12

Normal distribution with parameters:

Mean 15.89
Std. Dev. 0.07

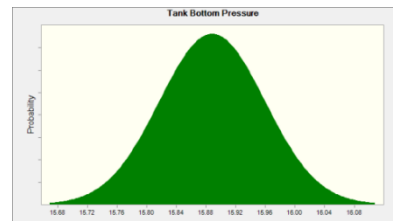

Assumption: Tank Bottom Temperature

Cell: S11

Uniform distribution with parameters:

Minimum 43.50
Maximum 46.50

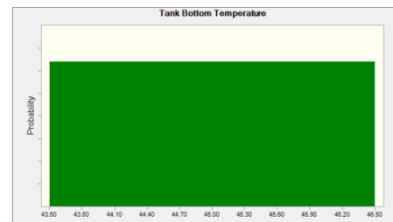

Assumption: Tank HS Pressure

Cell: S10

Uniform distribution with parameters:

Minimum 12.43
Maximum 12.67

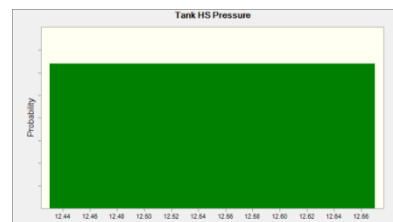

Assumption: Tank HS Temperature

Cell: S9

Uniform distribution with parameters:

Minimum

83.48

Maximum

87.52

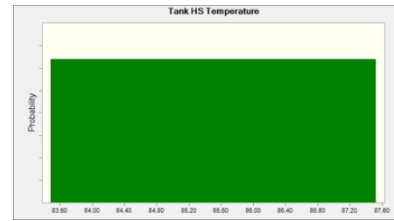

Assumption: Toluene

Cell: F18

Normal distribution with parameters:

Mean

1.317

Std. Dev.

0.008

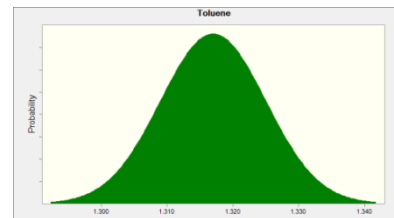

Assumption: Volume Flow (Std. Bbl)

Cell: F40

Normal distribution with parameters:

Mean

0.642

Std. Dev.

0.002

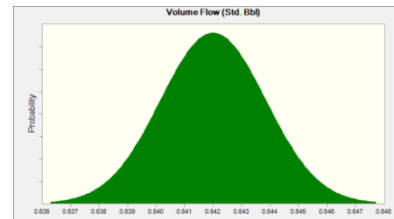

End of Assumptions

Summer PHLSA Study – HP3 – GPA 2103M

Crystal Ball Report - Full

Simulation started on 5/16/2017 at 8:03 PM
 Simulation stopped on 5/17/2017 at 4:57 PM

Run preferences:

Number of trials run	3,000
Monte Carlo	
Random seed	
Precision control on	
Confidence level	95.00%

Run statistics:

Total running time (sec)	75227.02
Trials/second (average)	0
Random numbers per sec	1

Crystal Ball data:

Assumptions	32
Correlations	0
Correlated groups	0
Decision variables	0
Forecasts	4

Forecasts

Worksheet: [Excel_HYSYS_PHLSA.xlsx]Input & Output

Forecast: Flash Gas to Oil Ratio (FGOR) - Standard (scf/bbl)

Cell: S34

Summary:

Entire range is from 353.763 to 390.451
 Base case is 374.079
 After 3,000 trials, the std. error of the mean is 0.110

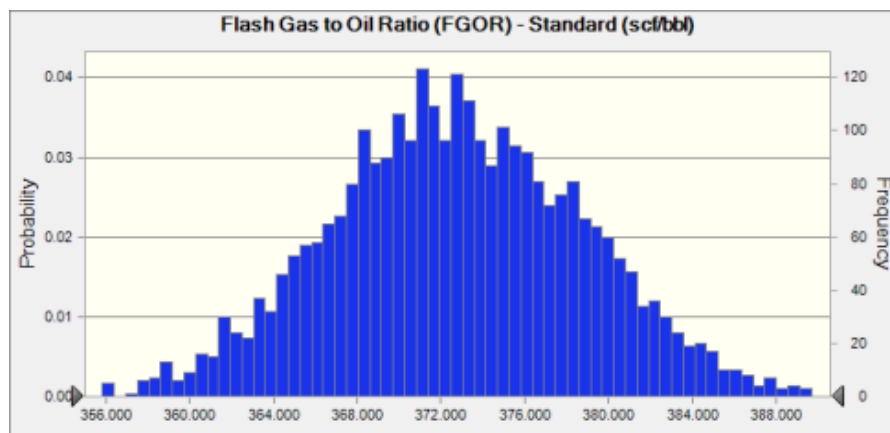

Statistics:	Forecast values
Trials	3,000
Base Case	374.079
Mean	372.760
Median	372.607
Mode	---
Standard Deviation	6.046
Variance	36.550
Skewness	0.0392
Kurtosis	2.80
Coeff. of Variability	0.0162
Minimum	353.763
Maximum	390.451
Range Width	36.688
Mean Std. Error	0.110

Forecast: Flash Gas to Oil Ratio (FGOR) - Standard (scf/bbl) (cont'd)**Cell: S34**

Percentiles:	Forecast values
0%	353.763
10%	365.027
20%	367.662
30%	369.517
40%	371.098
50%	372.605
60%	374.205
70%	375.985
80%	378.099
90%	380.600
100%	390.451

Forecast: Flash MW**Cell: S29****Summary:**

Entire range is from 42.400 to 43.822

Base case is 43.028

After 3,000 trials, the std. error of the mean is 0.004

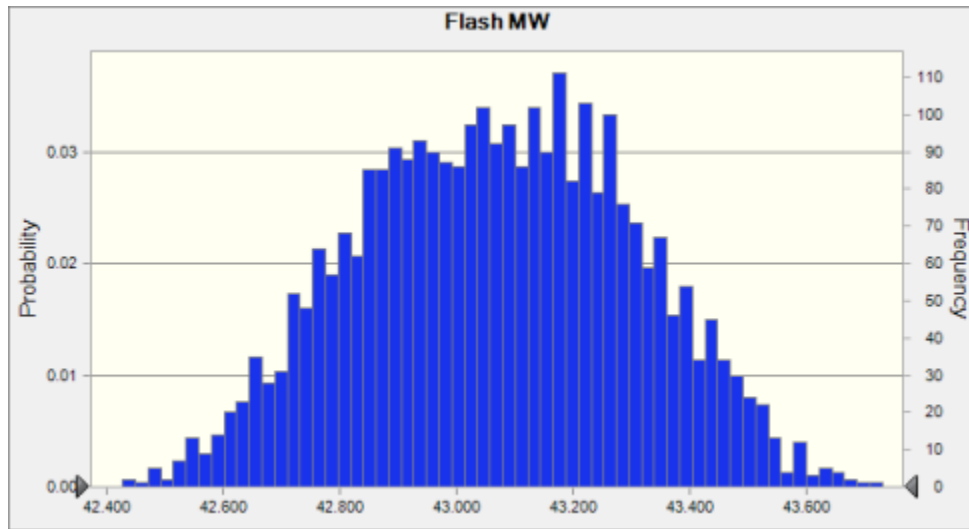

Statistics:	Forecast values
Trials	3,000
Base Case	43.028
Mean	43.068
Median	43.069
Mode	---
Standard Deviation	0.236
Variance	0.056
Skewness	0.0024
Kurtosis	2.50
Coeff. of Variability	0.0055
Minimum	42.400
Maximum	43.822
Range Width	1.422
Mean Std. Error	0.004

Forecast: Flash MW (cont'd)

Cell: S29

Percentiles:	Forecast values
0%	42.400
10%	42.756
20%	42.856
30%	42.929
40%	43.002
50%	43.068
60%	43.138
70%	43.207
80%	43.279
90%	43.379
100%	43.822

Forecast: Sample Bubble Point at Tsep

Cell: S6

Summary:

Entire range is from 263.71 to 289.04

Base case is 277.92

After 3,000 trials, the std. error of the mean is 0.06

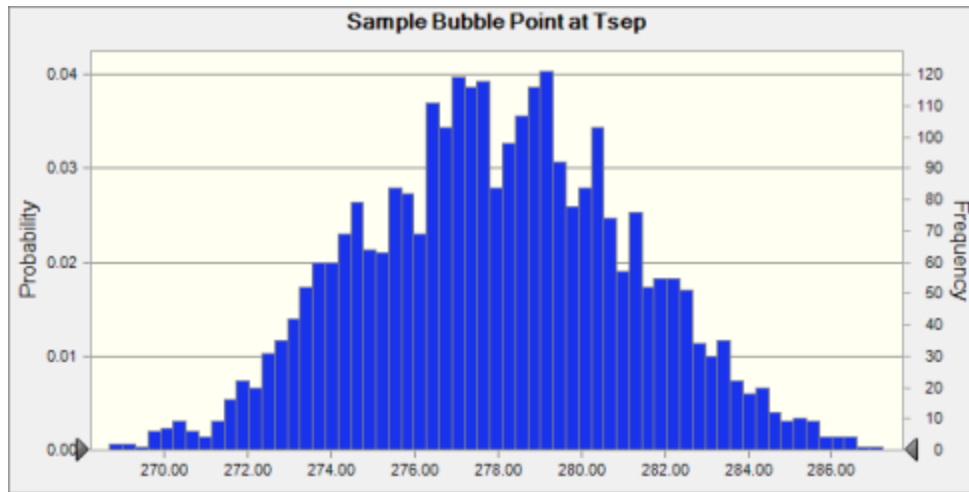

Statistics:	Forecast values
Trials	3,000
Base Case	277.92
Mean	277.96
Median	277.90
Mode	---
Standard Deviation	3.31
Variance	10.94
Skewness	0.0299
Kurtosis	3.04
Coeff. of Variability	0.0119
Minimum	263.71
Maximum	289.04
Range Width	25.33
Mean Std. Error	0.06

Forecast: Sample Bubble Point at Tsep (cont'd)

Cell: S6

Percentiles:	Forecast values
0%	263.71
10%	273.66
20%	275.03
30%	276.25
40%	277.14
50%	277.90
60%	278.81
70%	279.67
80%	280.72
90%	282.21
100%	289.04

Forecast: Shrinkage Factor

Cell: S37

Summary:

Entire range is from 0.812 to 0.829
 Base case is 0.820
 After 3,000 trials, the std. error of the mean is 0.000

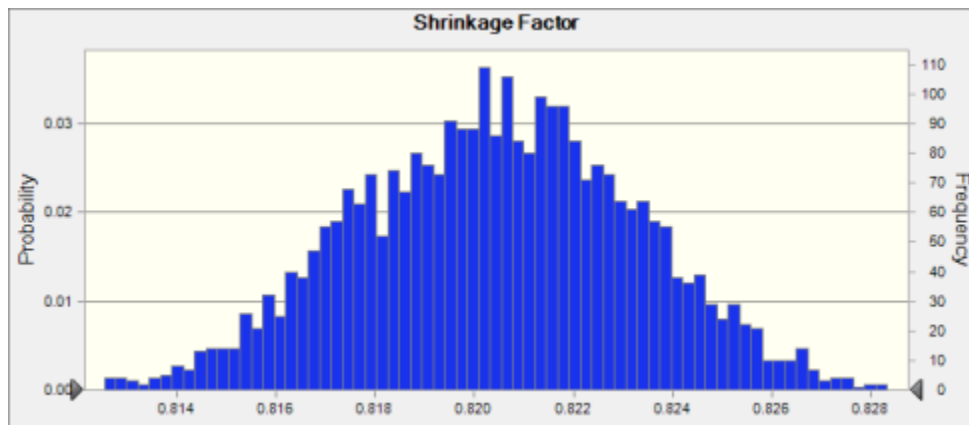

Statistics:	Forecast values
Trials	3,000
Base Case	0.820
Mean	0.820
Median	0.820
Mode	---
Standard Deviation	0.003
Variance	0.000
Skewness	-0.0373
Kurtosis	2.72
Coeff. of Variability	0.0034
Minimum	0.812
Maximum	0.829
Range Width	0.017
Mean Std. Error	0.000

Forecast: Shrinkage Factor (cont'd)

Cell: S37

Percentiles:	Forecast values
0%	0.812
10%	0.817
20%	0.818
30%	0.819
40%	0.820
50%	0.820
60%	0.821
70%	0.822
80%	0.823
90%	0.824
100%	0.829

End of Forecasts

Assumptions

Worksheet: [Excel_HYSYS_PHLA.xlsx]Input & Output

Assumption: 2,2,4-Trime thylpenta ne

Cell: F22

Normal distribution with parameters:	
Mean	0.043
Std. Dev.	0.001

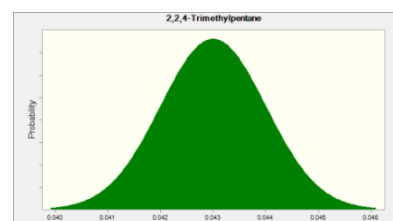

Assumption: 2,2-Dimethylbutane

Cell: F23

Normal distribution with parameters:

Mean

0.094

Std. Dev.

0.001

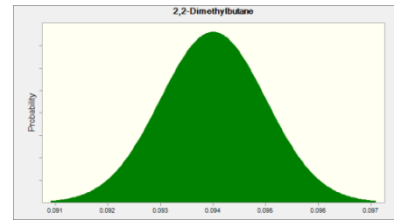

Assumption: 2,3-Dimethylbutane

Cell: F24

Normal distribution with parameters:

Mean

0.311

Std. Dev.

0.004

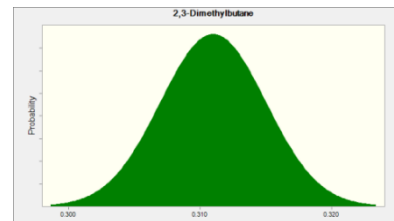

Assumption: 2-Methylpentane

Cell: F26

Normal distribution with parameters:

Mean

2.800

Std. Dev.

0.038

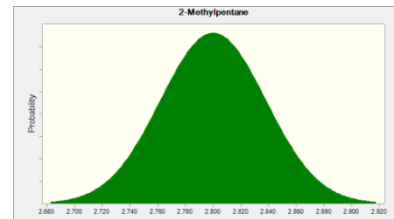

Assumption: 3-Methylpentane

Cell: F27

Normal distribution with parameters:

Mean

1.730

Std. Dev.

0.023

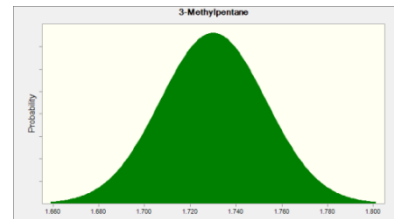

Assumption: Benzene

Cell: F17

Normal distribution with parameters:

Mean 0.749
Std. Dev. 0.010

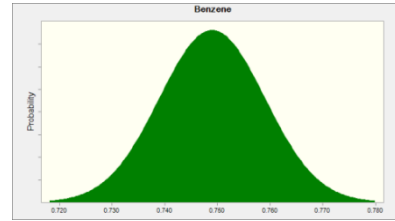

Assumption: Carbon Dioxide

Cell: F3

Normal distribution with parameters:

Mean 0.442
Std. Dev. 0.006

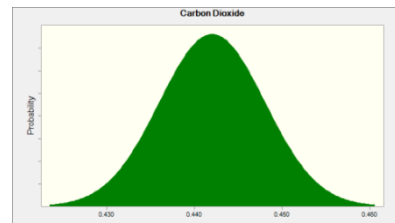

Assumption: Cyclopentane

Cell: F25

Normal distribution with parameters:

Mean 0.383
Std. Dev. 0.005

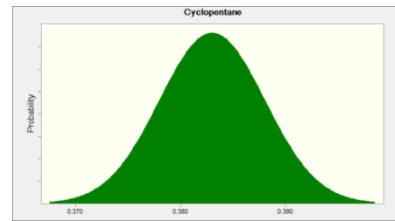

Assumption: Decanes Plus

Cell: F16

Normal distribution with parameters:

Mean 10.981
Std. Dev. 0.148

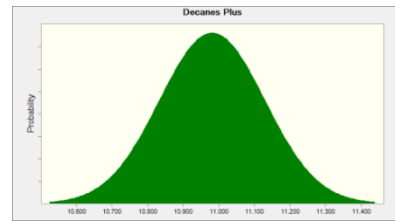

Assumption: Discharge Through Siphon Hole (fraction, 0-1)

Cell: S8

Uniform distribution with parameters:

Minimum 0.06
Maximum 0.06

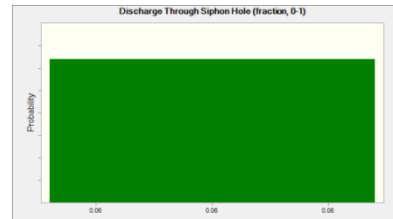

Assumption: Ethane

Cell: F6

Normal distribution with parameters:

Mean 6.490
Std. Dev. 0.088

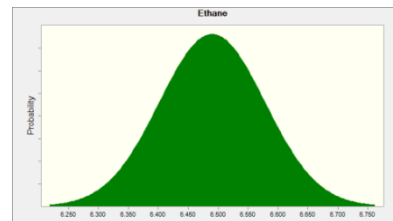

Assumption: Ethylbenzene

Cell: F19

Normal distribution with parameters:

Mean 0.188
Std. Dev. 0.003

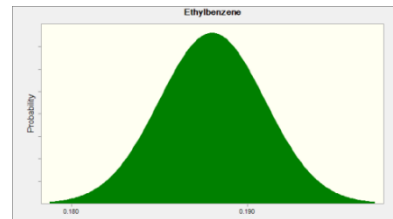

Assumption: Heptanes

Cell: F13

Normal distribution with parameters:

Mean 12.779
Std. Dev. 0.173

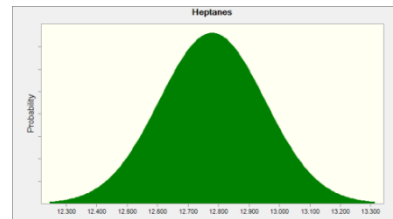

Assumption: Iso-Butane

Cell: F8

Normal distribution with parameters:

Mean 2.650
Std. Dev. 0.036

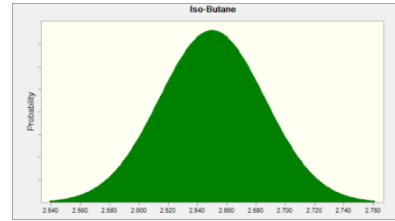

Assumption: Iso-Pentane

Cell: F10

Normal distribution with parameters:

Mean 4.990
Std. Dev. 0.067

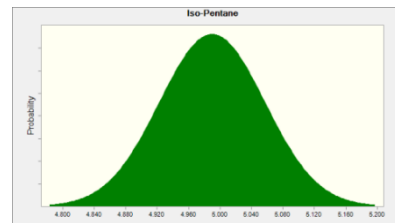

Assumption: m,p-Xylene (100% meta)

Cell: F20

Normal distribution with parameters:

Mean 2.170
Std. Dev. 0.029

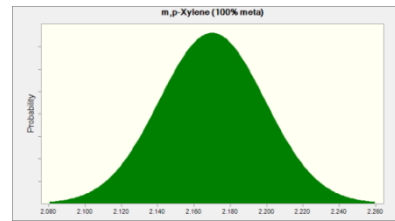

Assumption: Methane

Cell: F5

Normal distribution with parameters:

Mean 6.890
Std. Dev. 0.093

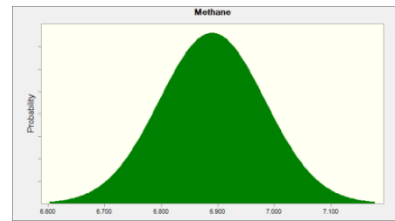

Assumption: n-Butane

Cell: F9

Normal distribution with parameters:

Mean

7.980

Std. Dev.

0.108

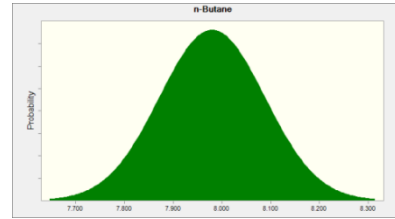

Assumption: n-Hexane

Cell: F12

Normal distribution with parameters:

Mean

5.600

Std. Dev.

0.076

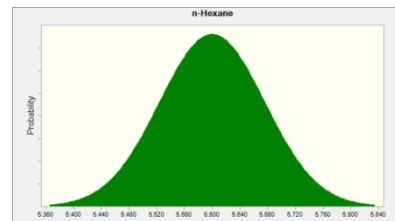

Assumption: Nonanes

Cell: F15

Normal distribution with parameters:

Mean

4.340

Std. Dev.

0.059

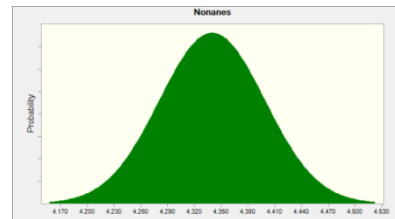

Assumption: n-Pentane

Cell: F11

Normal distribution with parameters:

Mean

6.870

Std. Dev.

0.093

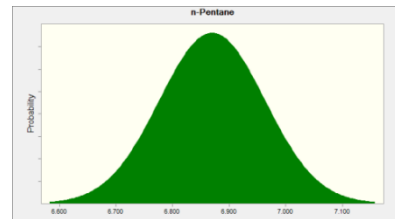

Assumption: Octanes

Cell: F14

Normal distribution with parameters:

Mean 10.258
Std. Dev. 0.138

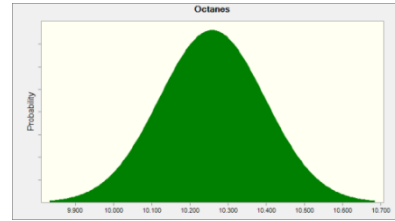

Assumption: o-Xylene

Cell: F21

Normal distribution with parameters:

Mean 0.492
Std. Dev. 0.007

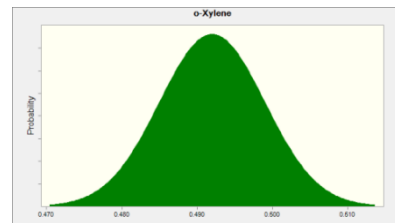

Assumption: Propane

Cell: F7

Normal distribution with parameters:

Mean 7.960
Std. Dev. 0.107

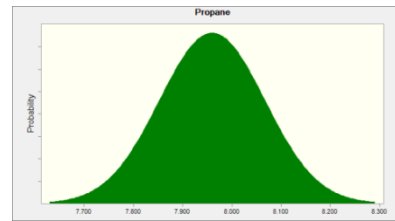

Assumption: Separator Pressure

Cell: S7

Uniform distribution with parameters:

Minimum 270.88
Maximum 283.84

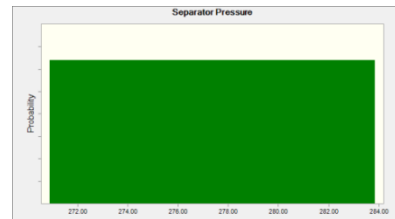

Assumption: Separator Temperature

Cell: S5

Uniform distribution with parameters:

Minimum 83.80
Maximum 87.80

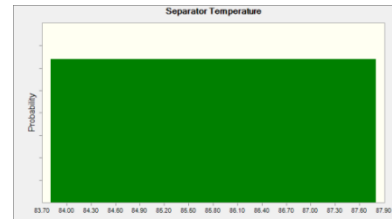

Assumption: Tank Bottom Pressure

Cell: S12

Normal distribution with parameters:

Mean 16.57
Std. Dev. 0.22

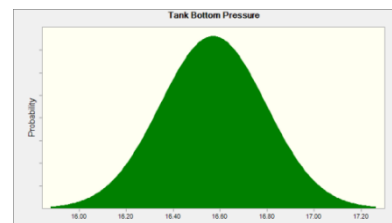

Assumption: Tank Bottom Temperature

Cell: S11

Uniform distribution with parameters:

Minimum 80.96
Maximum 84.84

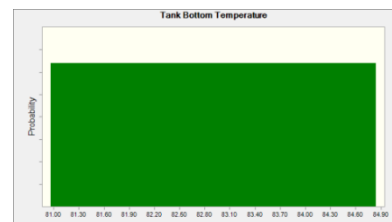

Assumption: Tank HS Pressure

Cell: S10

Uniform distribution with parameters:

Minimum 12.29
Maximum 12.87

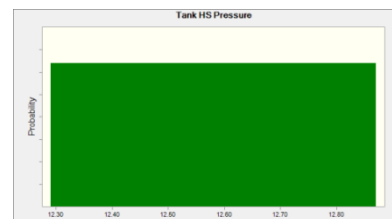

Assumption: Tank HS Temperature

Cell: S9

Uniform distribution with parameters:

Minimum
Maximum

97.47
102.13

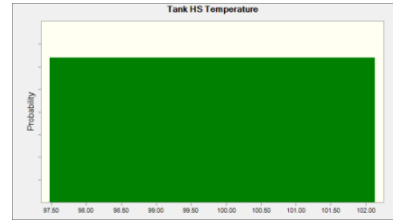

Assumption: Toluene

Cell: F18

Normal distribution with parameters:

Mean
Std. Dev.

2.810
0.038

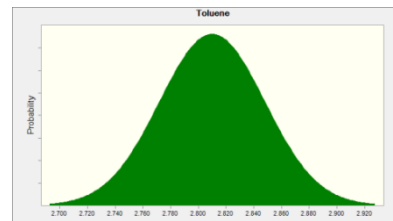

Assumption: Volume Flow (Std. Bbl)

Cell: F40

Normal distribution with parameters:

Mean
Std. Dev.

0.489
0.007

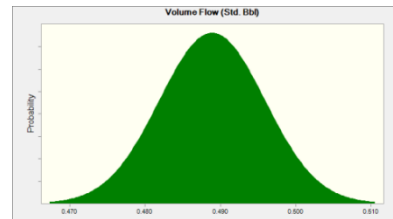

End of Assumptions

Summer PHLSA Study – HP3 – GPA 2186M**Crystal Ball Report - Full**

Simulation started on 4/26/2017 at 10:37 PM

Simulation stopped on 4/27/2017 at 5:50 PM

Run preferences:

Number of trials run	3,000
Monte Carlo	
Random seed	
Precision control on	
Confidence level	95.00%

Run statistics:

Total running time (sec)	69162.20
Trials/second (average)	0
Random numbers per sec	1

Crystal Ball data:

Assumptions	32
Correlations	0
Correlated groups	0
Decision variables	0
Forecasts	4

Forecasts**Worksheet: [Excel_HYSYS_PHLSA.xlsx]Input & Output****Forecast: Flash Gas to Oil Ratio (FGOR) - Standard (scf/bbl)****Cell: S34**

Summary:

Entire range is from 319.733 to 363.565

Base case is 339.787

After 3,000 trials, the std. error of the mean is 0.092

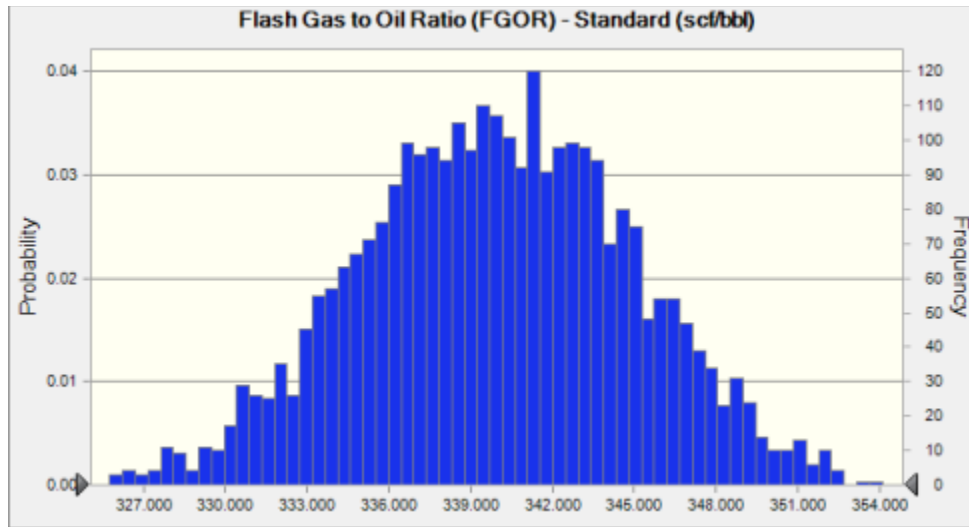

Statistics:	Forecast values
Trials	3,000
Base Case	339.787
Mean	339.933
Median	339.918
Mode	---
Standard Deviation	5.056
Variance	25.563
Skewness	-0.0111
Kurtosis	3.03
Coeff. of Variability	0.0149
Minimum	319.733
Maximum	363.565
Range Width	43.832
Mean Std. Error	0.092

Forecast: Flash Gas to Oil Ratio (FGOR) - Standard (scf/bbl) (cont'd)

Cell: S34

Percentiles:	Forecast values
0%	319.733
10%	333.442
20%	335.651
30%	337.181
40%	338.633
50%	339.917
60%	341.327
70%	342.687
80%	344.241
90%	346.384
100%	363.565

Forecast: Flash MW

Cell: S29

Summary:

Entire range is from 41.441 to 42.563

Base case is 42.064

After 3,000 trials, the std. error of the mean is 0.003

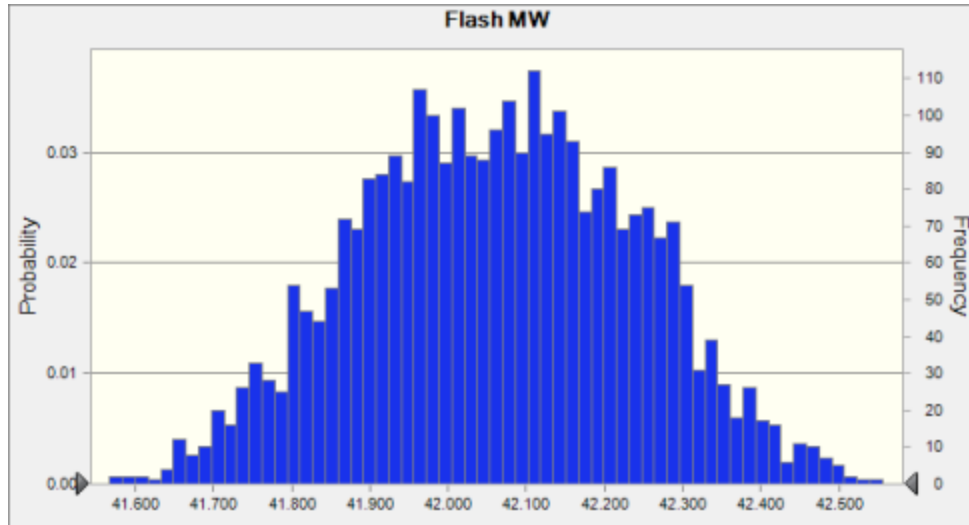

Statistics:

Forecast values

Trials	3,000
Base Case	42.064
Mean	42.061
Median	42.063
Mode	---
Standard Deviation	0.176
Variance	0.031
Skewness	-0.0260
Kurtosis	2.57
Coeff. of Variability	0.0042
Minimum	41.441
Maximum	42.563
Range Width	1.122
Mean Std. Error	0.003

Forecast: Flash MW (cont'd)

Cell: S29

Percentiles:	Forecast values
0%	41.441
10%	41.830
20%	41.904
30%	41.961
40%	42.011
50%	42.063
60%	42.111
70%	42.161
80%	42.221
90%	42.288
100%	42.563

Forecast: Sample Bubble Point at Tsep

Cell: S6

Summary:

Entire range is from 245.26 to 273.63

Base case is 258.71

After 3,000 trials, the std. error of the mean is 0.07

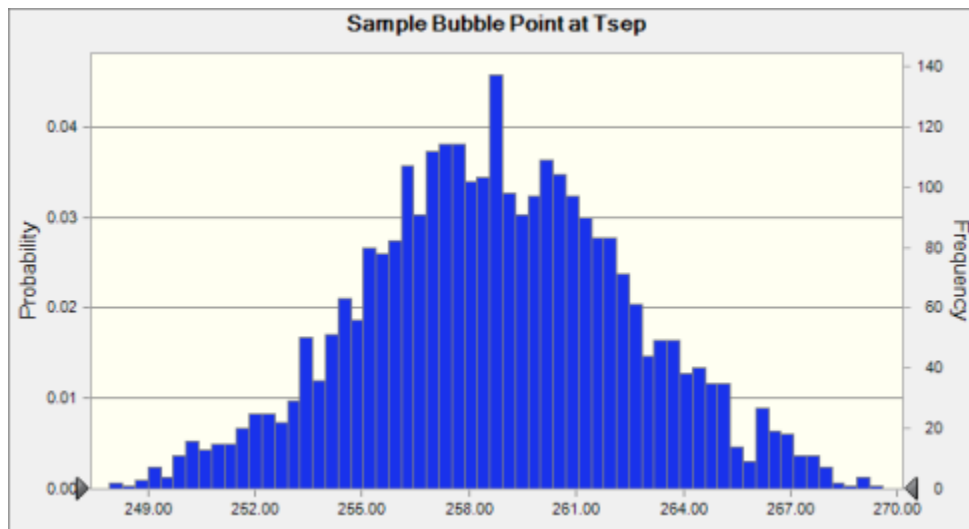

Statistics:	Forecast values
Trials	3,000
Base Case	258.71
Mean	258.75
Median	258.68
Mode	---
Standard Deviation	3.86
Variance	14.90
Skewness	0.0335
Kurtosis	3.16
Coeff. of Variability	0.0149
Minimum	245.26
Maximum	273.63
Range Width	28.37
Mean Std. Error	0.07

Forecast: Sample Bubble Point at Tsep (cont'd)

Cell: S6

Percentiles:	Forecast values
▼ 0%	245.26
▼ 10%	253.93
▼ 20%	255.62
▼ 30%	256.75
▼ 40%	257.69
▼ 50%	258.68
▼ 60%	259.69
▼ 70%	260.72
▼ 80%	261.94
▼ 90%	263.79
▼ 100%	273.63

Forecast: Shrinkage Factor

Cell: S37

Summary:

Entire range is from 0.826 to 0.845
 Base case is 0.836
 After 3,000 trials, the std. error of the mean is 0.000

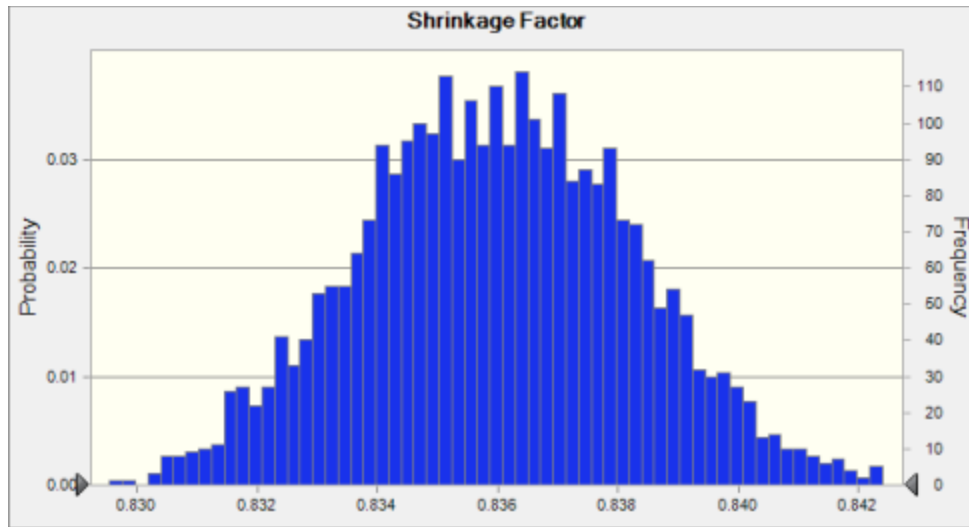

Statistics:	Forecast values
Trials	3,000
Base Case	0.836
Mean	0.836
Median	0.836
Mode	---
Standard Deviation	0.002
Variance	0.000
Skewness	0.0249
Kurtosis	2.93
Coeff. of Variability	0.0027
Minimum	0.826
Maximum	0.845
Range Width	0.019
Mean Std. Error	0.000

Forecast: Shrinkage Factor (cont'd)

Cell: S37

Percentiles:	Forecast values
0%	0.826
10%	0.833
20%	0.834
30%	0.835
40%	0.835
50%	0.836
60%	0.837
70%	0.837
80%	0.838
90%	0.839
100%	0.845

End of Forecasts

Assumptions

Worksheet: [Excel_HYSYS_PHLA.xlsx]Input & Output

Assumption: 2,2,4-Trime thylpenta ne

Cell: F22

Normal distribution with parameters:

Mean 0.058
 Std. Dev. 0.000

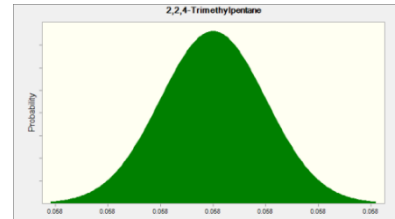

Assumption: 2,2-Dimethylbutane

Cell: F23

Normal distribution with parameters:

Mean 0.050
 Std. Dev. 0.000

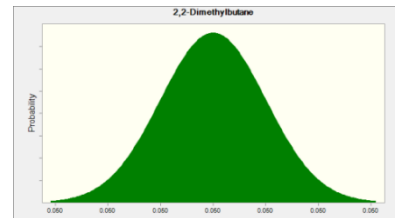

Assumption: 2,3-Dimethylbutane

Cell: F24

Normal distribution with parameters:

Mean 0.162
 Std. Dev. 0.000

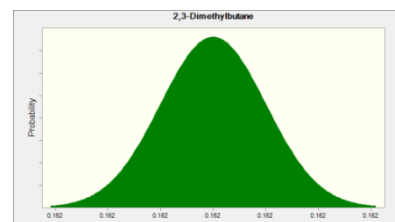

Assumption: 2-Methylpentane

Cell: F26

Normal distribution with parameters:

Mean 1.200
 Std. Dev. 0.002

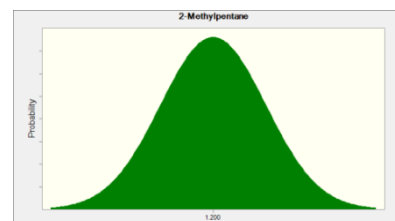

Assumption: 3-Methylpentane

Cell: F27

Normal distribution with parameters:

Mean 0.696
Std. Dev. 0.001

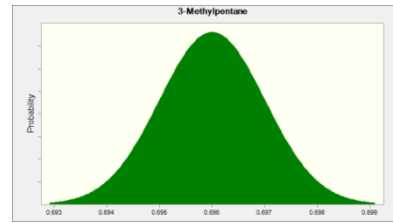

Assumption: Benzene

Cell: F17

Normal distribution with parameters:

Mean 0.304
Std. Dev. 0.006

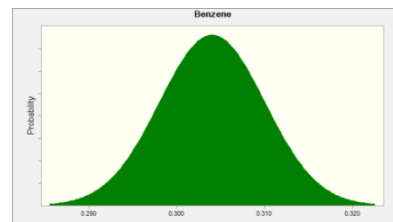

Assumption: Carbon Dioxide

Cell: F3

Normal distribution with parameters:

Mean 0.423
Std. Dev. 0.013

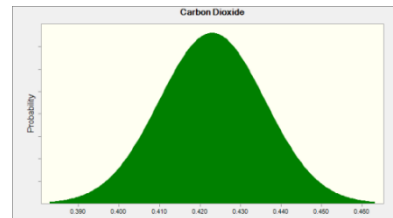

Assumption: Cyclopentane

Cell: F25

Normal distribution with parameters:

Mean 0.198
Std. Dev. 0.000

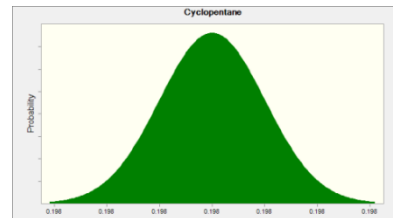

Assumption: Decanes Plus

Cell: F16

Normal distribution with parameters:

Mean 23.430
 Std. Dev. 0.371

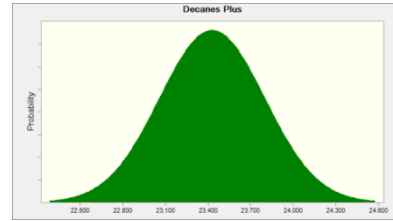

Assumption: Discharge Through Siphon Hole (fraction, 0-1)

Cell: S8

Uniform distribution with parameters:

Minimum 0.04
 Maximum 0.08

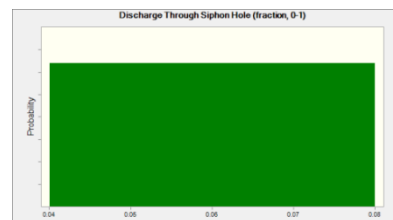

Assumption: Ethane

Cell: F6

Normal distribution with parameters:

Mean 6.350
 Std. Dev. 0.045

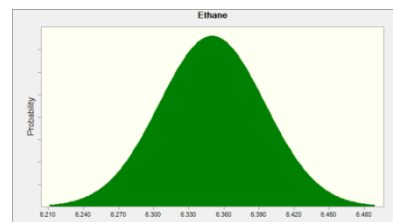

Assumption: Ethylbenzene

Cell: F19

Normal distribution with parameters:

Mean 0.125
 Std. Dev. 0.009

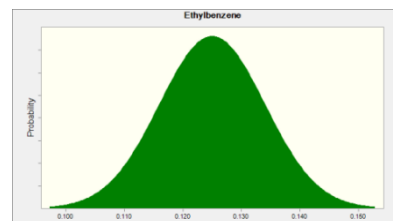

Assumption: Heptanes

Cell: F13

Normal distribution with parameters:

Mean 11.665
Std. Dev. 0.066

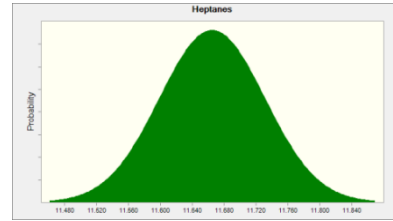

Assumption: Iso-Butane

Cell: F8

Normal distribution with parameters:

Mean 2.630
Std. Dev. 0.014

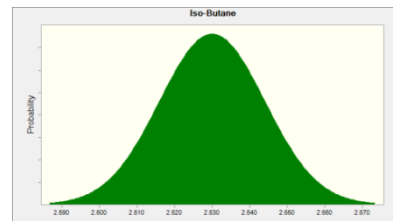

Assumption: Iso-Pentane

Cell: F10

Normal distribution with parameters:

Mean 4.986
Std. Dev. 0.086

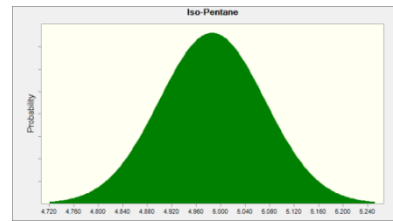

Assumption: m,p-Xylene (100% meta)

Cell: F20

Normal distribution with parameters:

Mean 1.370
Std. Dev. 0.009

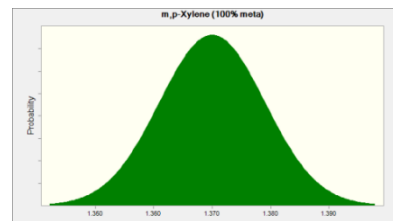

Assumption: Methane

Cell: F5

Normal distribution with parameters:

Mean

6.480

Std. Dev.

0.117

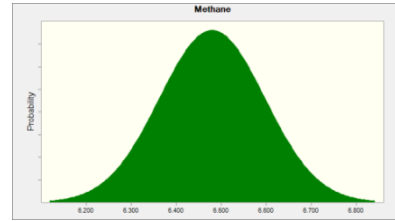

Assumption: n-Butane

Cell: F9

Normal distribution with parameters:

Mean

8.190

Std. Dev.

0.032

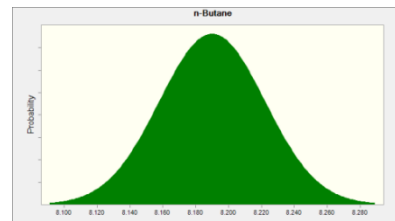

Assumption: n-Hexane

Cell: F12

Normal distribution with parameters:

Mean

2.150

Std. Dev.

0.009

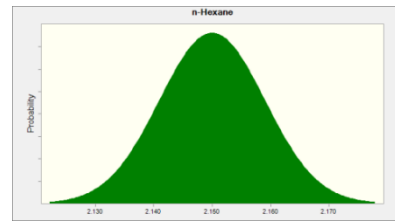

Assumption: Nonanes

Cell: F15

Normal distribution with parameters:

Mean

3.520

Std. Dev.

0.054

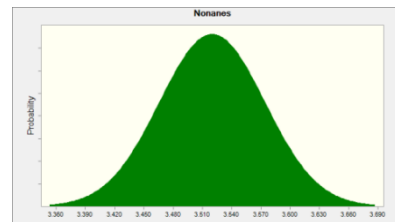

Assumption: n-Pentane

Cell: F11

Normal distribution with parameters:

Mean 6.860
Std. Dev. 0.025

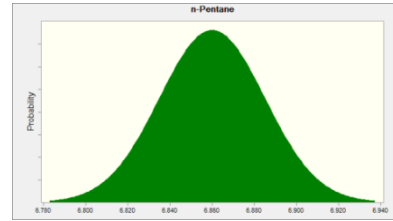

Assumption: Octanes

Cell: F14

Normal distribution with parameters:

Mean 9.492
Std. Dev. 0.196

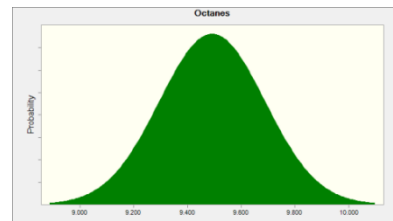

Assumption: o-Xylene

Cell: F21

Normal distribution with parameters:

Mean 0.291
Std. Dev. 0.002

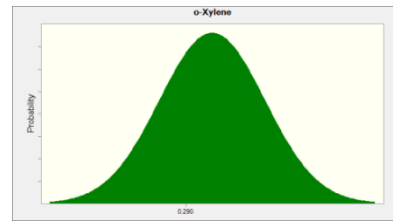

Assumption: Propane

Cell: F7

Normal distribution with parameters:

Mean 7.880
Std. Dev. 0.064

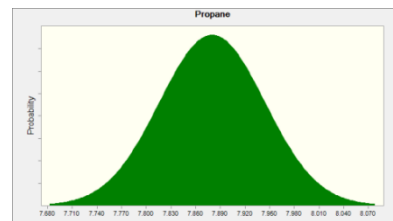

Assumption: Separator Pressure

Cell: S7

Uniform distribution with parameters:

Minimum 271.73
Maximum 282.99

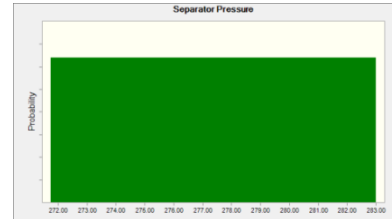

Assumption: Separator Temperature

Cell: S5

Uniform distribution with parameters:

Minimum 83.72
Maximum 87.88

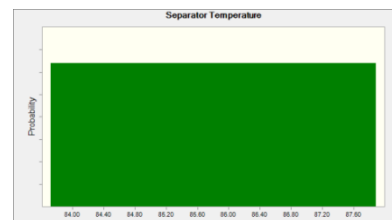

Assumption: Tank Bottom Pressure

Cell: S12

Normal distribution with parameters:

Mean 16.55
Std. Dev. 0.07

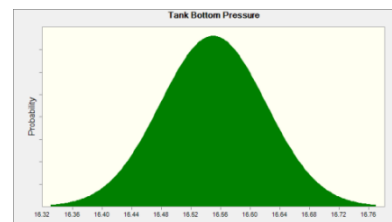

Assumption: Tank Bottom Temperature

Cell: S11

Uniform distribution with parameters:

Minimum 81.39
Maximum 84.41

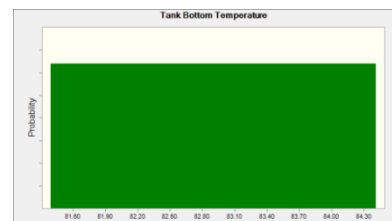

Assumption: Tank HS Pressure

Cell: S10

Uniform distribution with parameters:

Minimum 12.46
Maximum 12.70

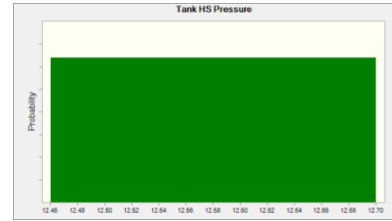

Assumption: Tank HS Temperature

Cell: S9

Uniform distribution with parameters:

Minimum 97.78
Maximum 101.82

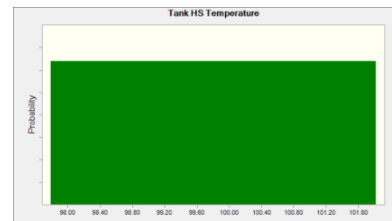

Assumption: Toluene

Cell: F18

Normal distribution with parameters:

Mean 1.490
Std. Dev. 0.009

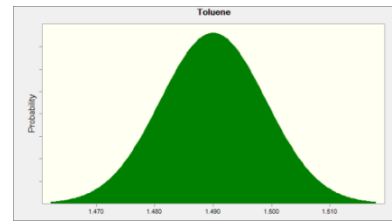

Assumption: Volume Flow (Std. Bbl)

Cell: F40

Normal distribution with parameters:

Mean 0.489
Std. Dev. 0.001

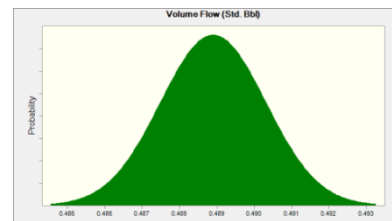

End of Assumptions

Crystal Ball Report - Full

Simulation started on 4/27/2017 at 7:39 PM

Simulation stopped on 4/28/2017 at 4:05 PM

Run preferences:

Number of trials run	3,000
Monte Carlo	
Random seed	
Precision control on	
Confidence level	95.00%

Run statistics:

Total running time (sec)	73581.37
Trials/second (average)	0
Random numbers per sec	1

Crystal Ball data:

Assumptions	32
Correlations	0
Correlated groups	0
Decision variables	0
Forecasts	4

Forecasts**Worksheet: [Excel_HYSYS_PHLA.xlsx]Input & Output****Forecast: Flash Gas to Oil Ratio (FGOR) - Standard (scf/bbl)****Cell: S34**

Summary:

Entire range is from 294.065 to 324.190

Base case is 310.770

After 3,000 trials, the std. error of the mean is 0.082

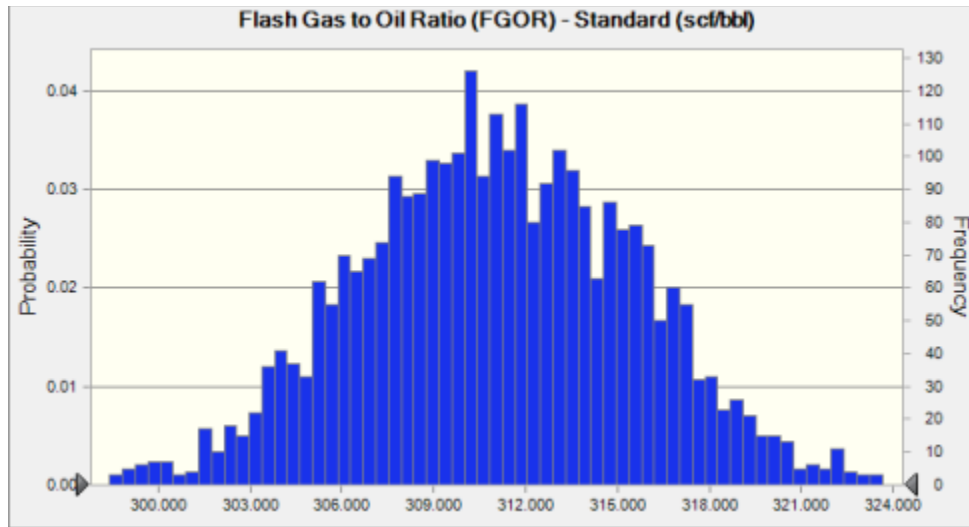

Statistics:	Forecast values
Trials	3,000
Base Case	310.770
Mean	311.033
Median	311.033
Mode	---
Standard Deviation	4.503
Variance	20.273
Skewness	-0.0245
Kurtosis	2.82
Coeff. of Variability	0.0145
Minimum	294.065
Maximum	324.190
Range Width	30.124
Mean Std. Error	0.082

Forecast: Flash Gas to Oil Ratio (FGOR) - Standard (scf/bbl) (cont'd)

Cell: S34

Percentiles:	Forecast values
0%	294.065
10%	305.266
20%	307.205
30%	308.591
40%	309.879
50%	311.031
60%	312.195
70%	313.523
80%	315.039
90%	316.821
100%	324.190

Forecast: Flash MW

Cell: S29

Summary:

Entire range is from 42.205 to 43.342

Base case is 42.789

After 3,000 trials, the std. error of the mean is 0.003

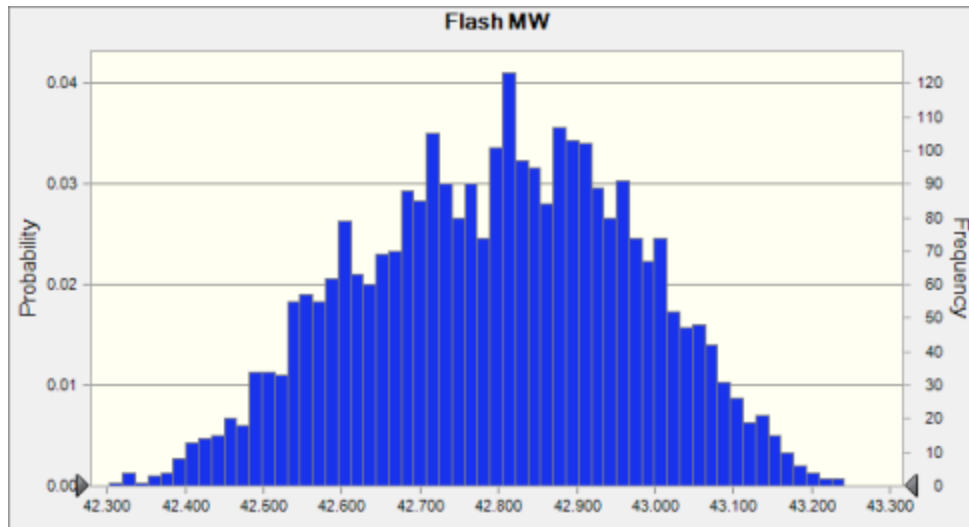

Statistics:	Forecast values
Trials	3,000
Base Case	42.789
Mean	42.797
Median	42.807
Mode	---
Standard Deviation	0.176
Variance	0.031
Skewness	-0.1242
Kurtosis	2.45
Coeff. of Variability	0.0041
Minimum	42.205
Maximum	43.342
Range Width	1.137
Mean Std. Error	0.003

Forecast: Flash MW (cont'd)

Cell: S29

Percentiles:	Forecast values
0%	42.205
10%	42.557
20%	42.635
30%	42.698
40%	42.751
50%	42.807
60%	42.853
70%	42.902
80%	42.956
90%	43.022
100%	43.342

Forecast: Sample Bubble Point at Tsep

Cell: S6

Summary:

Entire range is from 226.59 to 245.79

Base case is 236.56

After 3,000 trials, the std. error of the mean is 0.05

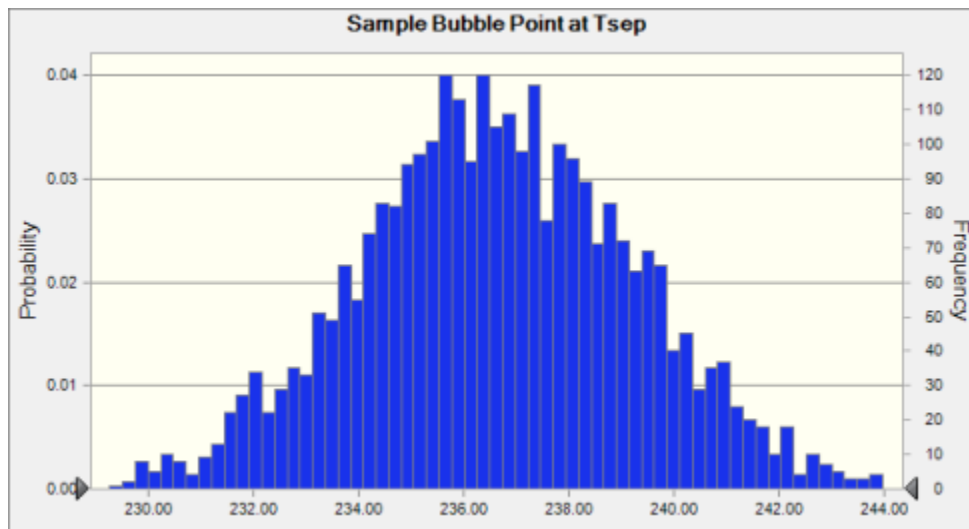

Statistics:	Forecast values
Trials	3,000
Base Case	236.56
Mean	236.61
Median	236.56
Mode	---
Standard Deviation	2.62
Variance	6.88
Skewness	-0.0041
Kurtosis	2.98
Coeff. of Variability	0.0111
Minimum	226.59
Maximum	245.79
Range Width	19.20
Mean Std. Error	0.05

Forecast: Sample Bubble Point at Tsep (cont'd)**Cell: S6**

Percentiles:	Forecast values
0%	226.59
10%	233.27
20%	234.41
30%	235.24
40%	235.91
50%	236.56
60%	237.24
70%	237.99
80%	238.85
90%	239.94
100%	245.79

Forecast: Shrinkage Factor**Cell: S37**

Summary:

Entire range is from 0.841 to 0.855

Base case is 0.847

After 3,000 trials, the std. error of the mean is 0.000

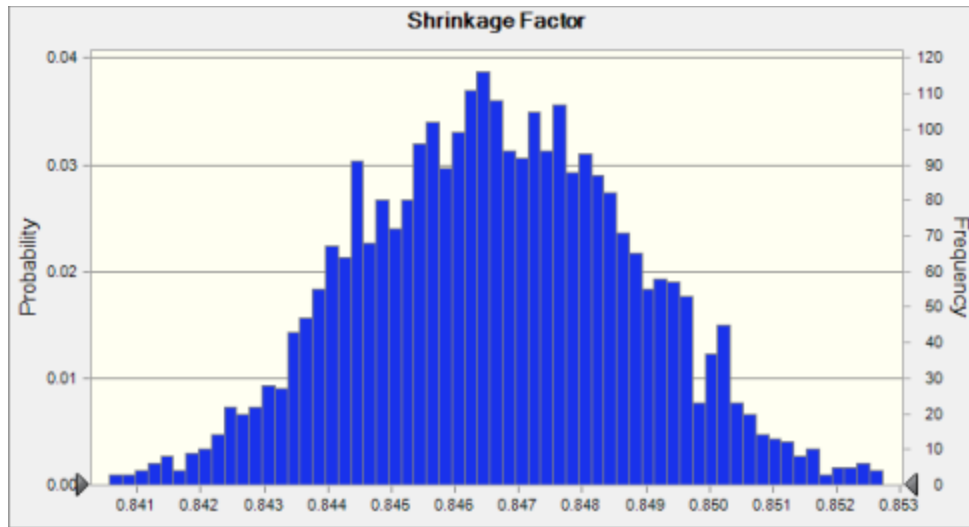

Statistics:	Forecast values
Trials	3,000
Base Case	0.847
Mean	0.847
Median	0.847
Mode	---
Standard Deviation	0.002
Variance	0.000
Skewness	0.0441
Kurtosis	2.75
Coeff. of Variability	0.0026
Minimum	0.841
Maximum	0.855
Range Width	0.014
Mean Std. Error	0.000

Forecast: Shrinkage Factor (cont'd)

Cell: S37

Percentiles:	Forecast values
0%	0.841
10%	0.844
20%	0.845
30%	0.845
40%	0.846
50%	0.847
60%	0.847
70%	0.848
80%	0.849
90%	0.849
100%	0.855

End of Forecasts

Assumptions

Worksheet: [Excel_HYSYS_PHLA.xlsx]Input & Output

Assumption: 2,2,4-Trime thylpenta ne

Cell: F22

Normal distribution with parameters:

Mean 0.046
 Std. Dev. 0.000

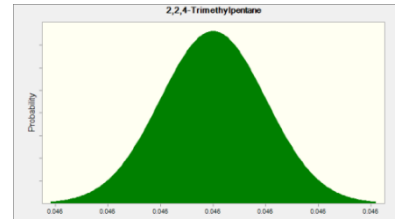

Assumption: 2,2-Dimethylbutane

Cell: F23

Normal distribution with parameters:

Mean 0.086
 Std. Dev. 0.000

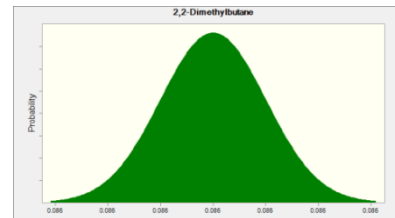

Assumption: 2,3-Dimethylbutane

Cell: F24

Normal distribution with parameters:

Mean 0.299
 Std. Dev. 0.001

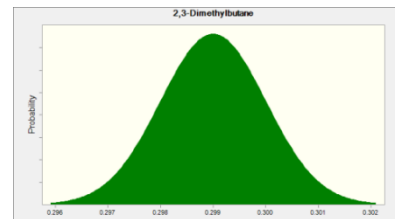

Assumption: 2-Methylpentane

Cell: F26

Normal distribution with parameters:

Mean 2.810
 Std. Dev. 0.007

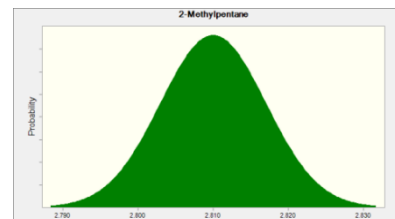

Assumption: 3-Methylpentane

Cell: F27

Normal distribution with parameters:

Mean 1.760
Std. Dev. 0.004

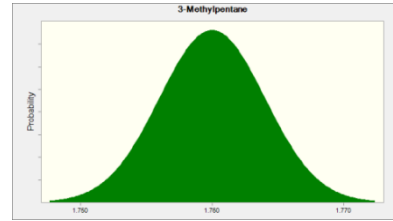

Assumption: Benzene

Cell: F17

Normal distribution with parameters:

Mean 0.773
Std. Dev. 0.021

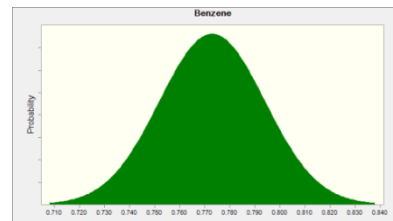

Assumption: Carbon Dioxide

Cell: F3

Normal distribution with parameters:

Mean 0.401
Std. Dev. 0.003

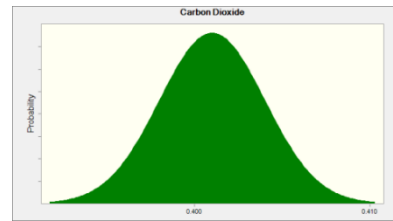

Assumption: Cyclopentane

Cell: F25

Normal distribution with parameters:

Mean 0.366
Std. Dev. 0.001

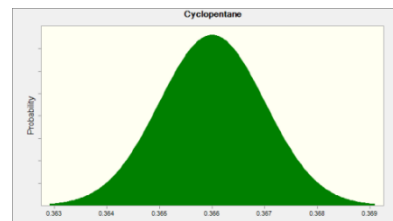

Assumption: Decanes Plus

Cell: F16

Normal distribution with parameters:

Mean 11.490
Std. Dev. 0.148

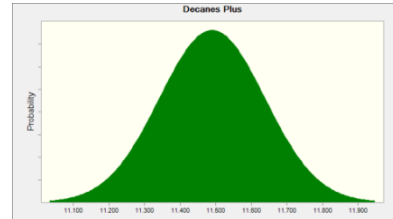

Assumption: Discharge Through Siphon Hole (fraction, 0-1)

Cell: S8

Uniform distribution with parameters:

Minimum 0.04
Maximum 0.08

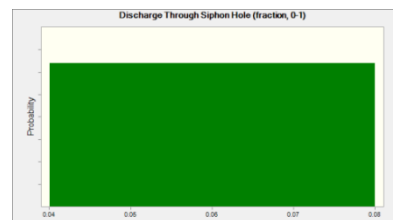

Assumption: Ethane

Cell: F6

Normal distribution with parameters:

Mean 6.130
Std. Dev. 0.048

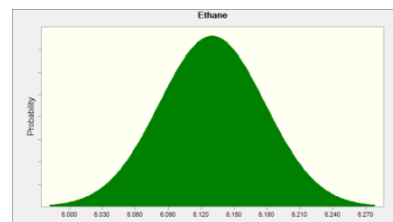

Assumption: Ethylbenzene

Cell: F19

Normal distribution with parameters:

Mean 0.189
Std. Dev. 0.018

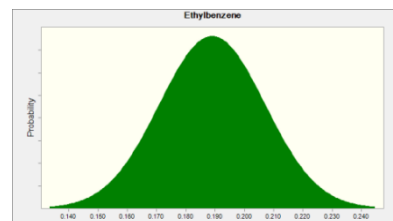

Assumption: Heptanes

Cell: F13

Normal distribution with parameters:

Mean 13.303
Std. Dev. 0.202

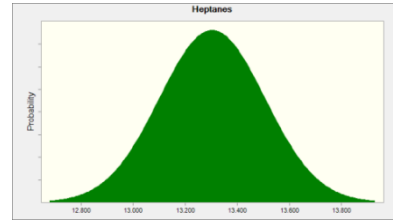

Assumption: Iso-Butane

Cell: F8

Normal distribution with parameters:

Mean 2.540
Std. Dev. 0.012

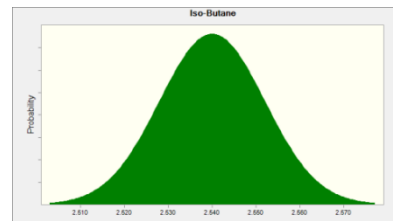

Assumption: Iso-Pentane

Cell: F10

Normal distribution with parameters:

Mean 4.990
Std. Dev. 0.059

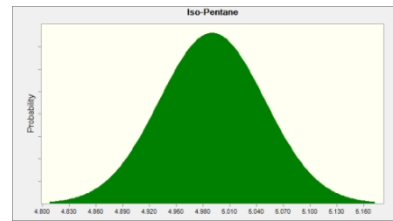

Assumption: m,p-Xylene (100% meta)

Cell: F20

Normal distribution with parameters:

Mean 2.210
Std. Dev. 0.029

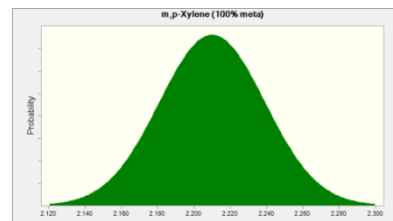

Assumption: Methane

Cell: F5

Normal distribution with parameters:

Mean

5.770

Std. Dev.

0.063

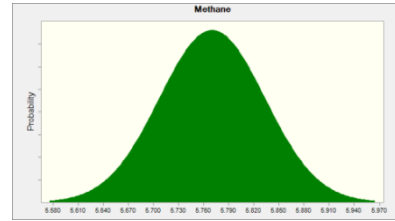

Assumption: n-Butane

Cell: F9

Normal distribution with parameters:

Mean

7.760

Std. Dev.

0.040

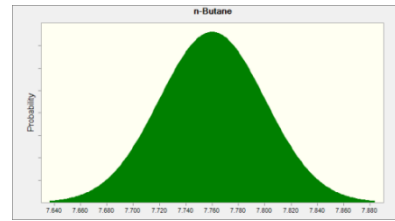

Assumption: n-Hexane

Cell: F12

Normal distribution with parameters:

Mean

5.770

Std. Dev.

0.125

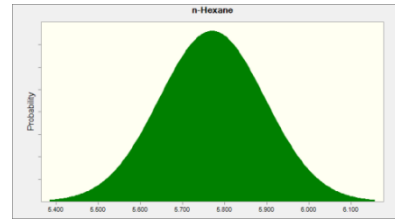

Assumption: Nonanes

Cell: F15

Normal distribution with parameters:

Mean

4.780

Std. Dev.

0.061

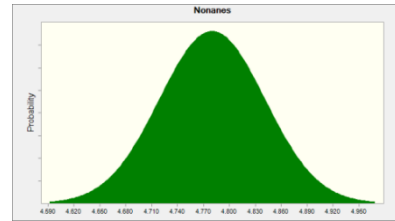

Assumption: n-Pentane

Cell: F11

Normal distribution with parameters:

Mean

6.970

Std. Dev.

0.029

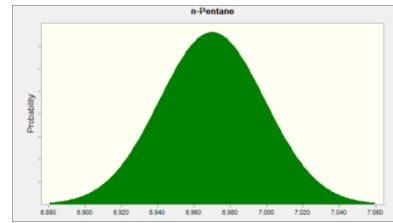

Assumption: Octanes

Cell: F14

Normal distribution with parameters:

Mean

10.577

Std. Dev.

0.346

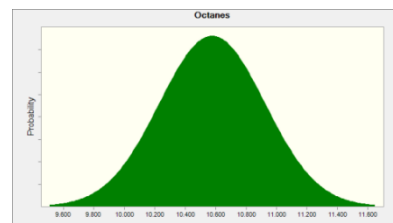

Assumption: o-Xylene

Cell: F21

Normal distribution with parameters:

Mean

0.510

Std. Dev.

0.007

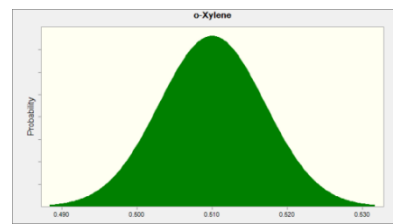

Assumption: Propane

Cell: F7

Normal distribution with parameters:

Mean

7.710

Std. Dev.

0.051

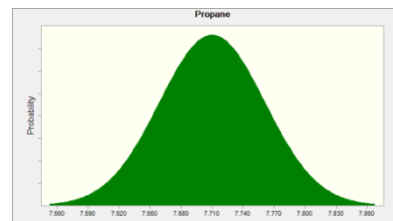

Assumption: Separator Pressure

Cell: S7

Uniform distribution with parameters:

Minimum 241.31
Maximum 251.35

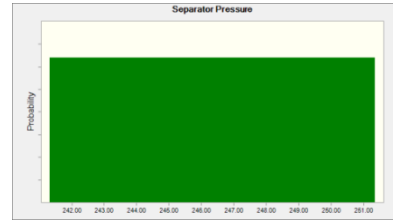

Assumption: Separator Temperature

Cell: S5

Uniform distribution with parameters:

Minimum 82.21
Maximum 86.19

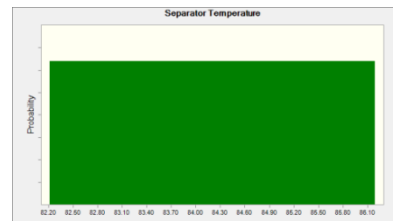

Assumption: Tank Bottom Pressure

Cell: S12

Normal distribution with parameters:

Mean 16.54
Std. Dev. 0.07

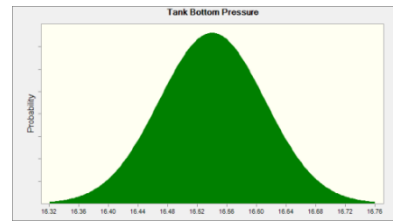

Assumption: Tank Bottom Temperature

Cell: S11

Uniform distribution with parameters:

Minimum 78.79
Maximum 81.81

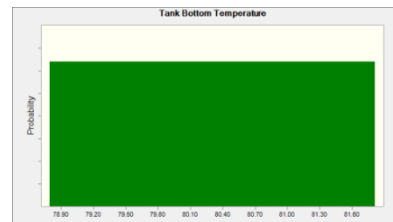

Assumption: Tank HS Pressure

Cell: S10

Uniform distribution with parameters:

Minimum 12.43
Maximum 12.67

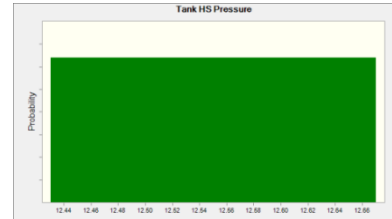

Assumption: Tank HS Temperature

Cell: S9

Uniform distribution with parameters:

Minimum 87.58
Maximum 91.62

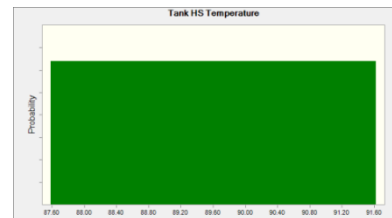

Assumption: Toluene

Cell: F18

Normal distribution with parameters:

Mean 2.760
Std. Dev. 0.031

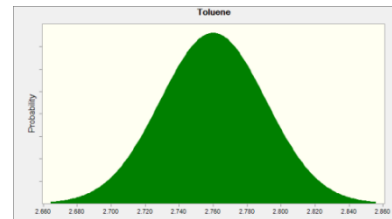

Assumption: Volume Flow (Std. Bbl)

Cell: F40

Normal distribution with parameters:

Mean 0.522
Std. Dev. 0.002

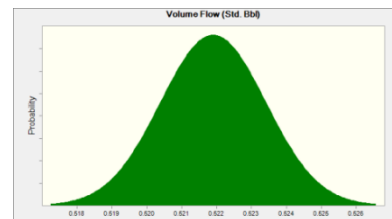

End of Assumptions

Crystal Ball Report - Full

Simulation started on 5/9/2017 at 7:00 PM
 Simulation stopped on 5/10/2017 at 8:49 PM

Run preferences:

Number of trials run	3,000
Monte Carlo	
Random seed	
Precision control on	
Confidence level	95.00%

Run statistics:

Total running time (sec)	92900.19
Trials/second (average)	0
Random numbers per sec	1

Crystal Ball data:

Assumptions	32
Correlations	0
Correlated groups	0
Decision variables	0
Forecasts	4

Forecasts

Worksheet: [Excel_HYSYS_PHLSA.xlsx]Input & Output

Forecast: Flash Gas to Oil Ratio (FGOR) - Standard (scf/bbl)

Cell: S34

Summary:

Entire range is from 286.003 to 315.355
 Base case is 300.418
 After 3,000 trials, the std. error of the mean is 0.083

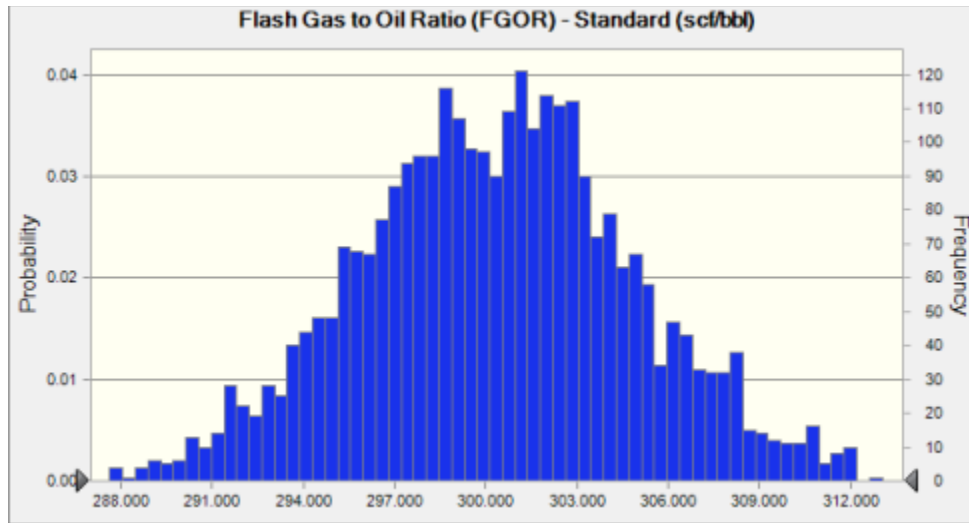

Statistics:	Forecast values
Trials	3,000
Base Case	300.418
Mean	300.344
Median	300.381
Mode	---
Standard Deviation	4.536
Variance	20.572
Skewness	0.0349
Kurtosis	2.93
Coeff. of Variability	0.0151
Minimum	286.003
Maximum	315.355
Range Width	29.352
Mean Std. Error	0.083

Forecast: Flash Gas to Oil Ratio (FGOR) - Standard (scf/bbl) (cont'd)

Cell: S34

Percentiles:	Forecast values
0%	286.003
10%	294.464
20%	296.532
30%	297.914
40%	299.125
50%	300.377
60%	301.494
70%	302.659
80%	304.084
90%	306.244
100%	315.355

Forecast: Flash MW

Cell: S29

Summary:

Entire range is from 40.978 to 42.022

Base case is 41.515

After 3,000 trials, the std. error of the mean is 0.003

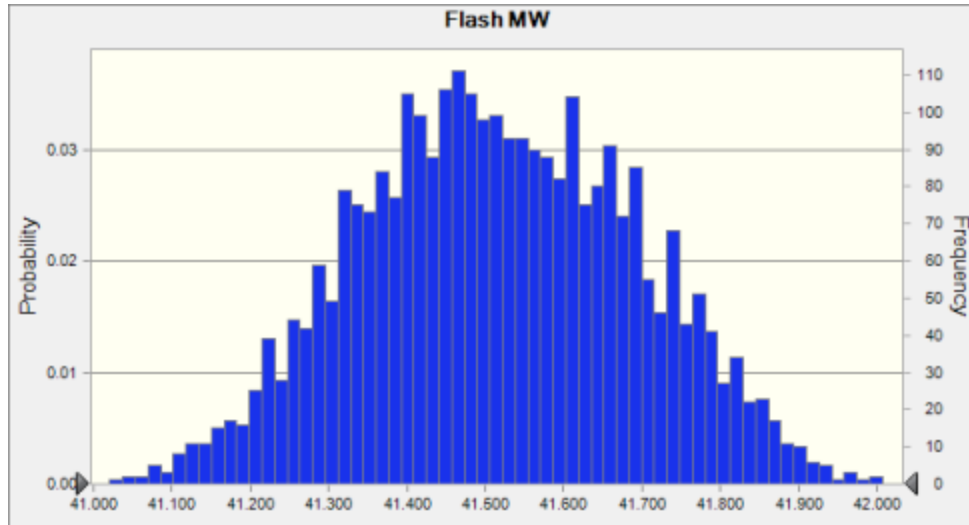

Statistics:	Forecast values
Trials	3,000
Base Case	41.515
Mean	41.514
Median	41.508
Mode	---
Standard Deviation	0.176
Variance	0.031
Skewness	0.0078
Kurtosis	2.55
Coeff. of Variability	0.0042
Minimum	40.978
Maximum	42.022
Range Width	1.045
Mean Std. Error	0.003

Forecast: Flash MW (cont'd)

Cell: S29

Percentiles:	Forecast values
0%	40.978
10%	41.288
20%	41.358
30%	41.412
40%	41.462
50%	41.508
60%	41.561
70%	41.613
80%	41.671
90%	41.746
100%	42.022

Forecast: Sample Bubble Point at Tsep

Cell: S6

Summary:

Entire range is from 226.73 to 250.68

Base case is 239.57

After 3,000 trials, the std. error of the mean is 0.07

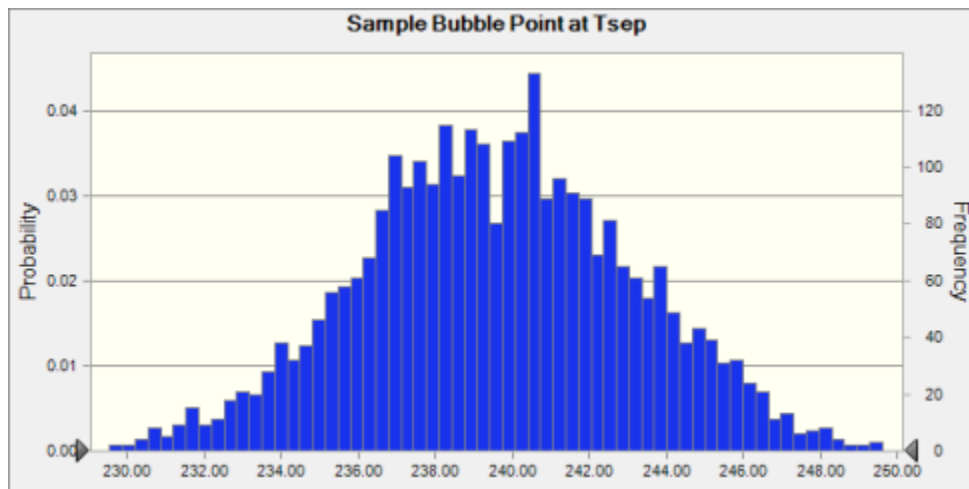

Statistics:	Forecast values
Trials	3,000
Base Case	239.57
Mean	239.58
Median	239.55
Mode	---
Standard Deviation	3.58
Variance	12.81
Skewness	-0.0251
Kurtosis	2.92
Coeff. of Variability	0.0149
Minimum	226.73
Maximum	250.68
Range Width	23.95
Mean Std. Error	0.07

Forecast: Sample Bubble Point at Tsep (cont'd)**Cell: S6**

Percentiles:	Forecast values
0%	226.73
10%	235.07
20%	236.61
30%	237.65
40%	238.59
50%	239.55
60%	240.47
70%	241.42
80%	242.63
90%	244.25
100%	250.68

Forecast: Shrinkage Factor**Cell: S37**

Summary:

Entire range is from 0.848 to 0.861

Base case is 0.854

After 3,000 trials, the std. error of the mean is 0.000

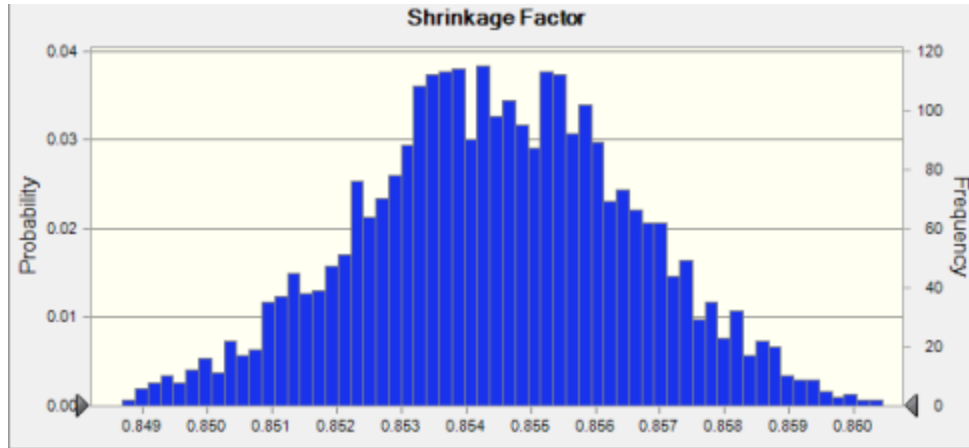

Statistics:	Forecast values
Trials	3,000
Base Case	0.854
Mean	0.854
Median	0.854
Mode	---
Standard Deviation	0.002
Variance	0.000
Skewness	-0.0490
Kurtosis	2.85
Coeff. of Variability	0.0025
Minimum	0.848
Maximum	0.861
Range Width	0.013
Mean Std. Error	0.000

Forecast: Shrinkage Factor (cont'd)

Cell: S37

Percentiles:	Forecast values
0%	0.848
10%	0.852
20%	0.853
30%	0.853
40%	0.854
50%	0.854
60%	0.855
70%	0.856
80%	0.856
90%	0.857
100%	0.861

End of Forecasts

Assumptions

Worksheet: [Excel_HYSYS_PHLA.xlsx]Input & Output

Assumption: 2,2,4-Trime thylpenta ne

Cell: F22

Normal distribution with parameters:

Mean 0.056
 Std. Dev. 0.000

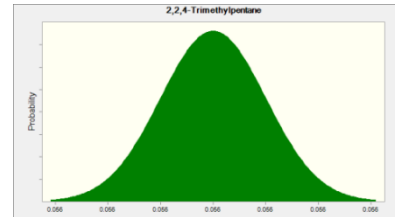

Assumption: 2,2-Dimethylbutane

Cell: F23

Normal distribution with parameters:

Mean 0.048
 Std. Dev. 0.000

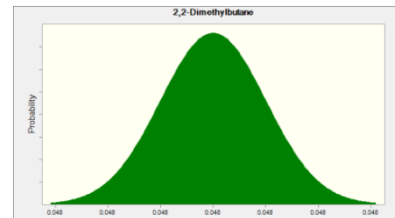

Assumption: 2,3-Dimethylbutane

Cell: F24

Normal distribution with parameters:

Mean 0.161
 Std. Dev. 0.000

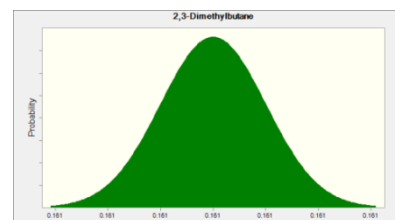

Assumption: 2-Methylpentane

Cell: F26

Normal distribution with parameters:

Mean 1.203
 Std. Dev. 0.002

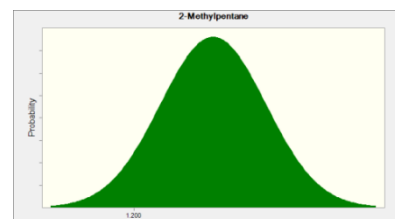

Assumption: 3-Methylpentane

Cell: F27

Normal distribution with parameters:

Mean 0.698
 Std. Dev. 0.001

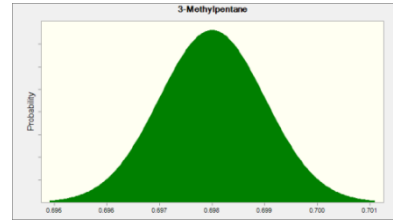

Assumption: Benzene

Cell: F17

Normal distribution with parameters:

Mean 0.305
 Std. Dev. 0.006

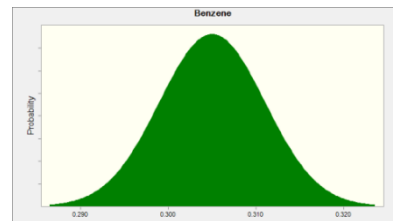

Assumption: Carbon Dioxide

Cell: F3

Normal distribution with parameters:

Mean 0.626
 Std. Dev. 0.019

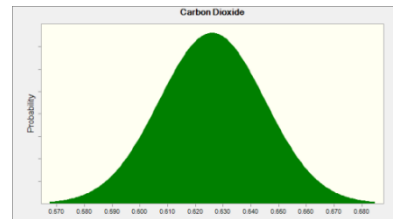

Assumption: Cyclopentane

Cell: F25

Normal distribution with parameters:

Mean 0.196
 Std. Dev. 0.000

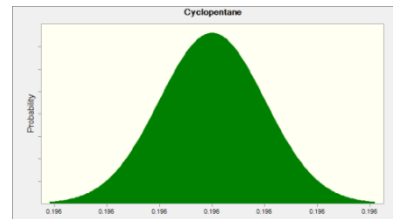

Assumption: Decanes Plus

Cell: F16

Normal distribution with parameters:

Mean 25.162
 Std. Dev. 0.398

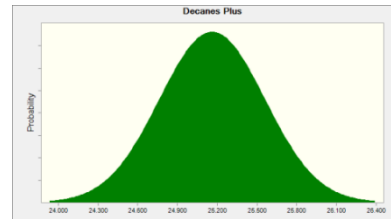

Assumption: Discharge Through Siphon Hole (fraction, 0-1)

Cell: S8

Uniform distribution with parameters:

Minimum 0.04
 Maximum 0.08

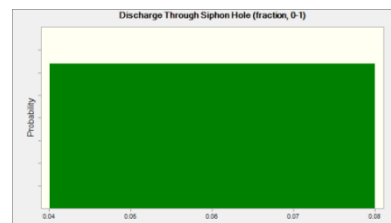

Assumption: Ethane

Cell: F6

Normal distribution with parameters:

Mean 6.058
 Std. Dev. 0.043

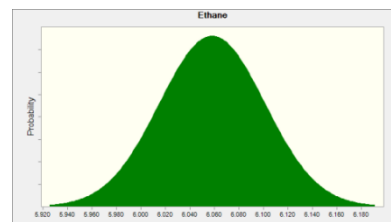

Assumption: Ethylbenzene

Cell: F19

Normal distribution with parameters:

Mean 0.116
 Std. Dev. 0.009

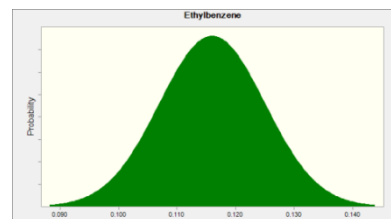

Assumption: Heptanes

Cell: F13

Normal distribution with parameters:

Mean 11.908
Std. Dev. 0.067

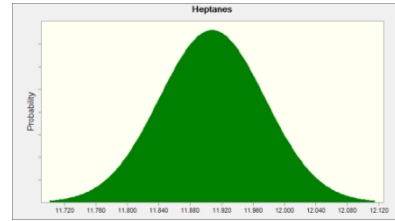

Assumption: Iso-Butane

Cell: F8

Normal distribution with parameters:

Mean 2.509
Std. Dev. 0.013

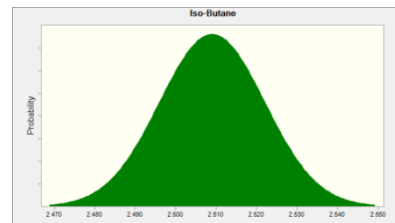

Assumption: Iso-Pentane

Cell: F10

Normal distribution with parameters:

Mean 4.910
Std. Dev. 0.085

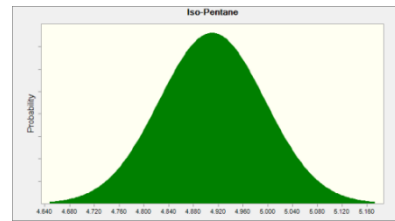

Assumption: m,p-Xylene (100% meta)

Cell: F20

Normal distribution with parameters:

Mean 1.258
Std. Dev. 0.008

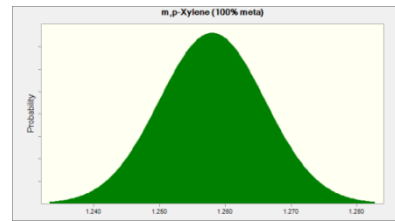

Assumption: Methane

Cell: F5

Normal distribution with parameters:

Mean

5.919

Std. Dev.

0.107

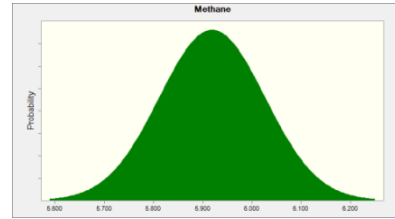

Assumption: n-Butane

Cell: F9

Normal distribution with parameters:

Mean

7.802

Std. Dev.

0.031

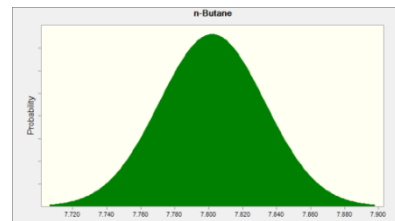

Assumption: n-Hexane

Cell: F12

Normal distribution with parameters:

Mean

2.153

Std. Dev.

0.009

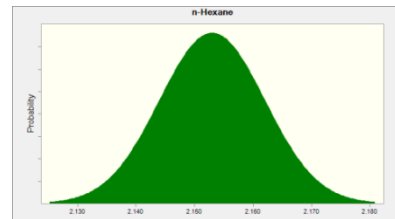

Assumption: Nonanes

Cell: F15

Normal distribution with parameters:

Mean

3.521

Std. Dev.

0.054

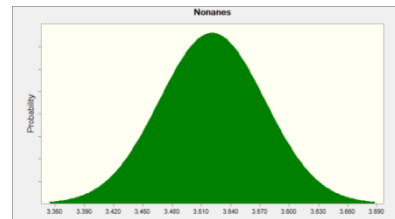

Assumption: n-Pentane

Cell: F11

Normal distribution with parameters:

Mean 6.868
Std. Dev. 0.025

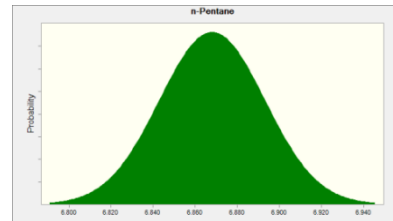

Assumption: Octanes

Cell: F14

Normal distribution with parameters:

Mean 9.397
Std. Dev. 0.194

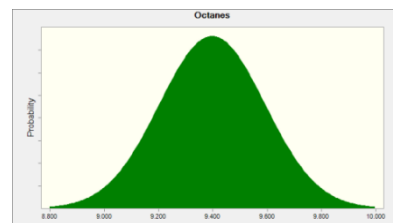

Assumption: o-Xylene

Cell: F21

Normal distribution with parameters:

Mean 0.253
Std. Dev. 0.002

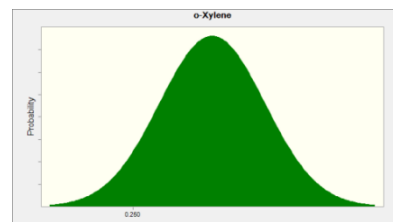

Assumption: Propane

Cell: F7

Normal distribution with parameters:

Mean 7.483
Std. Dev. 0.060

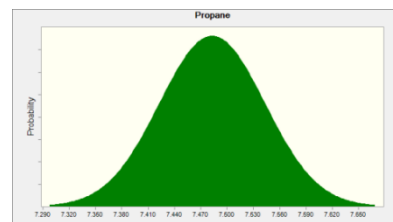

Assumption: Separator Pressure

Cell: S7

Uniform distribution with parameters:

Minimum 241.31
Maximum 251.35

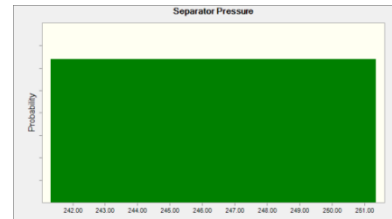

Assumption: Separator Temperature

Cell: S5

Uniform distribution with parameters:

Minimum 82.21
Maximum 86.19

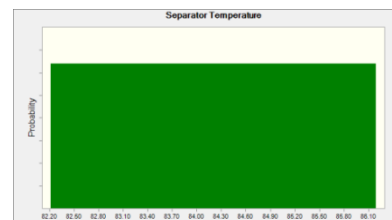

Assumption: Tank Bottom Pressure

Cell: S12

Normal distribution with parameters:

Mean 16.54
Std. Dev. 0.07

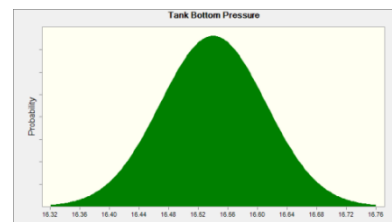

Assumption: Tank Bottom Temperature

Cell: S11

Uniform distribution with parameters:

Minimum 78.79
Maximum 81.81

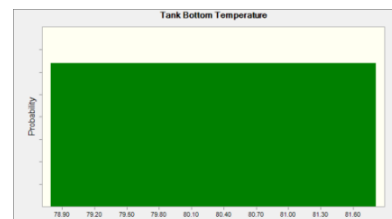

Assumption: Tank HS Pressure

Cell: S10

Uniform distribution with parameters:

Minimum 12.43
Maximum 12.67

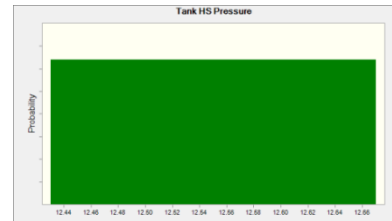

Assumption: Tank HS Temperature

Cell: S9

Uniform distribution with parameters:

Minimum 87.58
Maximum 91.62

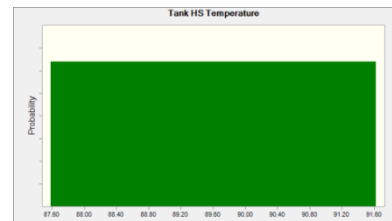

Assumption: Toluene

Cell: F18

Normal distribution with parameters:

Mean 1.390
Std. Dev. 0.008

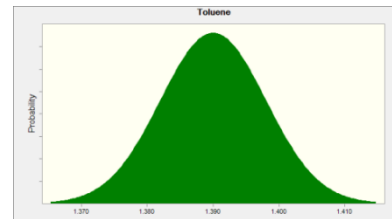

Assumption: Volume Flow (Std. Bbl)

Cell: F40

Normal distribution with parameters:

Mean 0.522
Std. Dev. 0.002

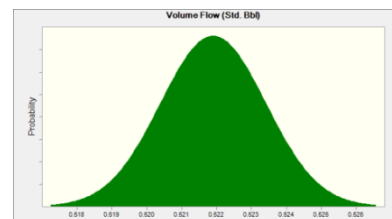

End of Assumptions

Crystal Ball Report - Full

Simulation started on 4/28/2017 at 6:25 PM

Simulation stopped on 4/29/2017 at 3:39 PM

Run preferences:

Number of trials run	3,000
Monte Carlo	
Random seed	
Precision control on	
Confidence level	95.00%

Run statistics:

Total running time (sec)	76401.72
Trials/second (average)	0
Random numbers per sec	1

Crystal Ball data:

Assumptions	32
Correlations	0
Correlated groups	0
Decision variables	0
Forecasts	4

Forecasts**Worksheet: [Excel_HYSYS_PHLSA.xlsx]Input & Output****Forecast: Flash Gas to Oil Ratio (FGOR) - Standard (scf/bbl)****Cell: S34**

Summary:

Entire range is from 231.047 to 255.399

Base case is 244.111

After 3,000 trials, the std. error of the mean is 0.067

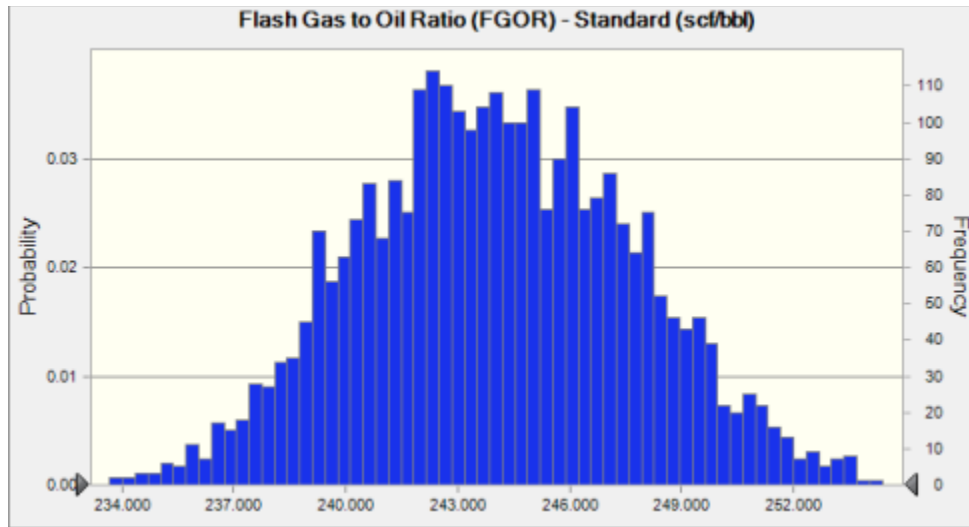

Statistics:	Forecast values
Trials	3,000
Base Case	244.111
Mean	244.029
Median	243.933
Mode	---
Standard Deviation	3.695
Variance	13.653
Skewness	0.0594
Kurtosis	2.77
Coeff. of Variability	0.0151
Minimum	231.047
Maximum	255.399
Range Width	24.352
Mean Std. Error	0.067

Forecast: Flash Gas to Oil Ratio (FGOR) - Standard (scf/bbl) (cont'd)

Cell: S34

Percentiles:	Forecast values
0%	231.047
10%	239.281
20%	240.773
30%	242.040
40%	242.959
50%	243.933
60%	244.948
70%	246.015
80%	247.244
90%	248.886
100%	255.399

Forecast: Flash MW

Cell: S29

Summary:

Entire range is from 42.709 to 43.868

Base case is 43.292

After 3,000 trials, the std. error of the mean is 0.004

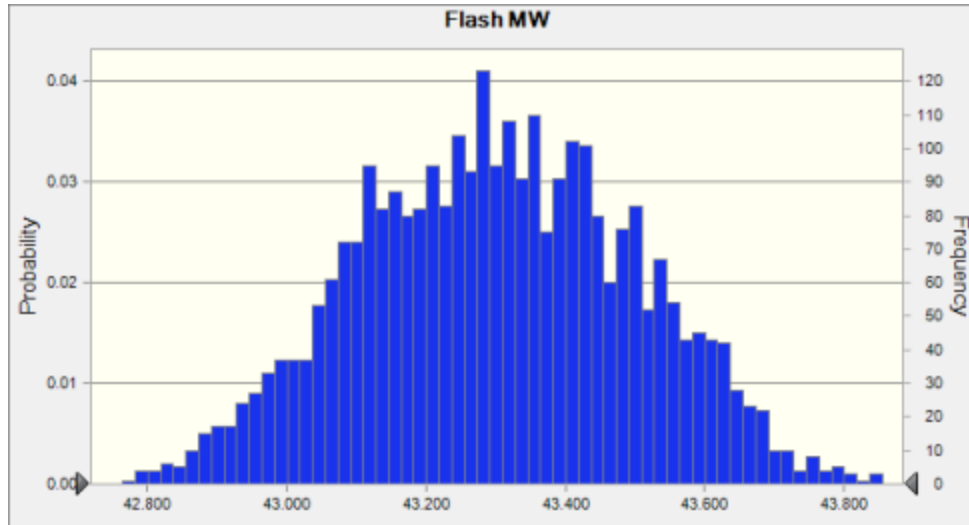

Statistics:

Forecast values

Trials	3,000
Base Case	43.292
Mean	43.300
Median	43.300
Mode	---
Standard Deviation	0.198
Variance	0.039
Skewness	-0.0040
Kurtosis	2.55
Coeff. of Variability	0.0046
Minimum	42.709
Maximum	43.868
Range Width	1.159
Mean Std. Error	0.004

Forecast: Flash MW (cont'd)

Cell: S29

Percentiles:	Forecast values
0%	42.709
10%	43.044
20%	43.122
30%	43.188
40%	43.249
50%	43.300
60%	43.352
70%	43.413
80%	43.478
90%	43.562
100%	43.868

Forecast: Sample Bubble Point at Tsep

Cell: S6

Summary:

Entire range is from 179.01 to 192.63

Base case is 186.44

After 3,000 trials, the std. error of the mean is 0.04

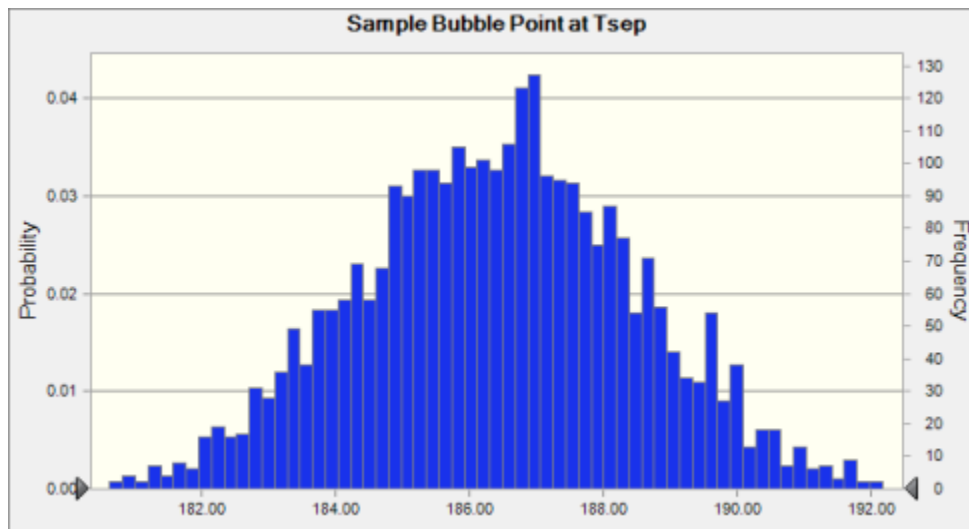

Statistics:	Forecast values
Trials	3,000
Base Case	186.44
Mean	186.40
Median	186.44
Mode	---
Standard Deviation	2.06
Variance	4.23
Skewness	-0.0348
Kurtosis	2.80
Coeff. of Variability	0.0110
Minimum	179.01
Maximum	192.63
Range Width	13.62
Mean Std. Error	0.04

Forecast: Sample Bubble Point at Tsep (cont'd)**Cell: S6**

Percentiles:	Forecast values
0%	179.01
10%	183.69
20%	184.65
30%	185.29
40%	185.86
50%	186.44
60%	186.93
70%	187.48
80%	188.14
90%	189.05
100%	192.63

Forecast: Shrinkage Factor**Cell: S37**

Summary:

Entire range is from 0.869 to 0.882

Base case is 0.875

After 3,000 trials, the std. error of the mean is 0.000

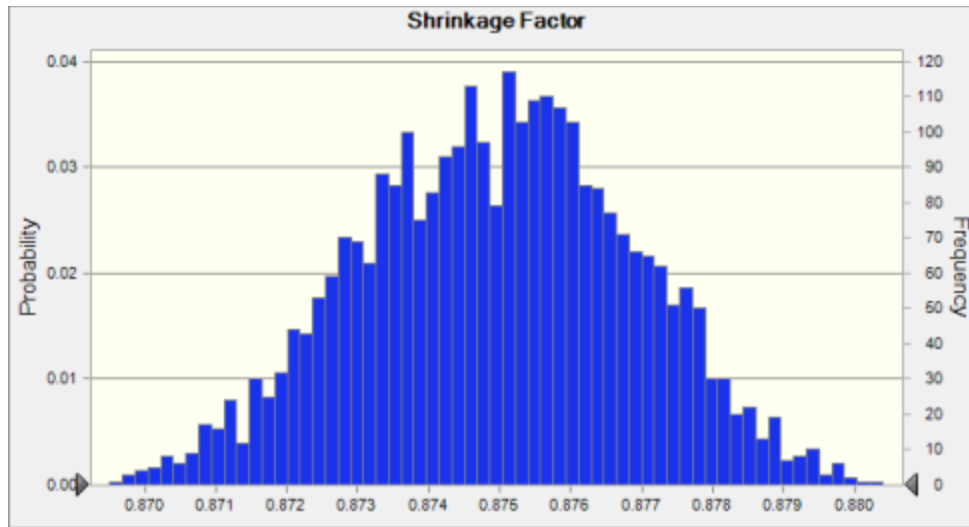

Statistics:	Forecast values
Trials	3,000
Base Case	0.875
Mean	0.875
Median	0.875
Mode	0.876
Standard Deviation	0.002
Variance	0.000
Skewness	-0.0530
Kurtosis	2.71
Coeff. of Variability	0.0022
Minimum	0.869
Maximum	0.882
Range Width	0.013
Mean Std. Error	0.000

Forecast: Shrinkage Factor (cont'd)

Cell: S37

Percentiles:	Forecast values
0%	0.869
10%	0.872
20%	0.873
30%	0.874
40%	0.874
50%	0.875
60%	0.876
70%	0.876
80%	0.877
90%	0.877
100%	0.882

End of Forecasts

Assumptions

Worksheet: [Excel_HYSYS_PHLA.xlsx]Input & Output

Assumption: 2,2,4-Trime thylpenta ne

Cell: F22

Normal distribution with parameters:

Mean 0.045
Std. Dev. 0.000

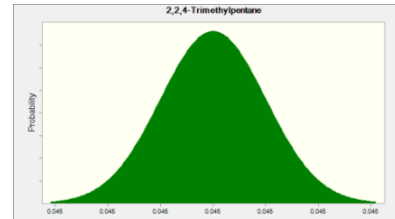

Assumption: 2,2-Dimethylbutane

Cell: F23

Normal distribution with parameters:

Mean 0.091
Std. Dev. 0.000

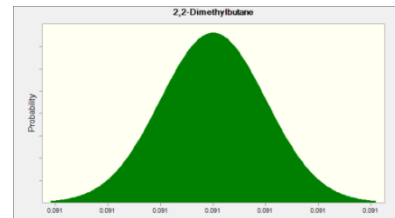

Assumption: 2,3-Dimethylbutane

Cell: F24

Normal distribution with parameters:

Mean 0.325
Std. Dev. 0.001

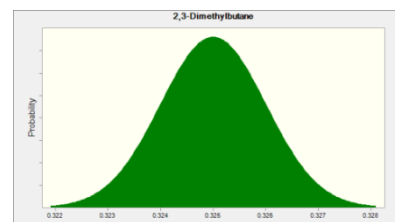

Assumption: 2-Methylpentane

Cell: F26

Normal distribution with parameters:

Mean 3.130
Std. Dev. 0.007

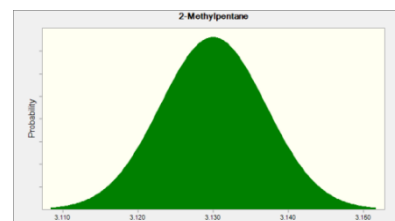

Assumption: 3-Methylpentane

Cell: F27

Normal distribution with parameters:

Mean 1.960
Std. Dev. 0.005

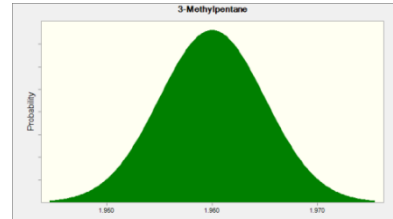

Assumption: Benzene

Cell: F17

Normal distribution with parameters:

Mean 0.851
Std. Dev. 0.023

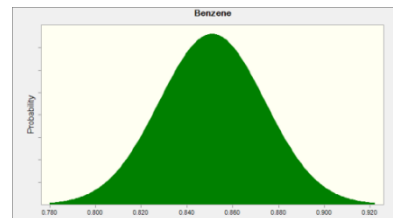

Assumption: Carbon Dioxide

Cell: F3

Normal distribution with parameters:

Mean 0.321
Std. Dev. 0.002

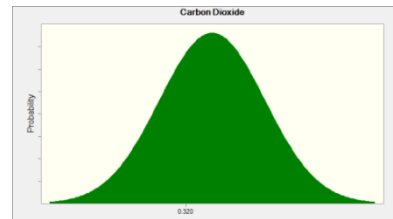

Assumption: Cyclopentane

Cell: F25

Normal distribution with parameters:

Mean 0.399
Std. Dev. 0.001

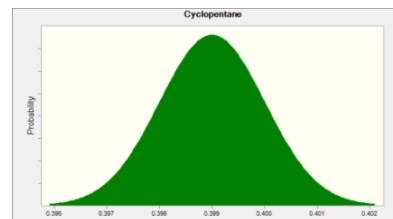

Assumption: Decanes Plus

Cell: F16

Normal distribution with parameters:

Mean 12.362
Std. Dev. 0.159

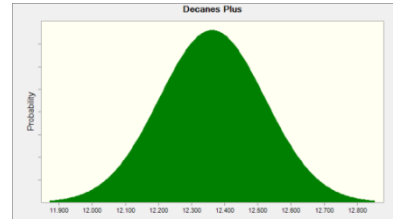

Assumption: Discharge Through Siphon Hole (fraction, 0-1)

Cell: S8

Uniform distribution with parameters:

Minimum 0.04
Maximum 0.08

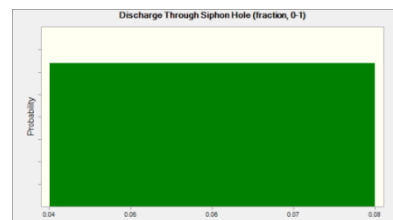

Assumption: Ethane

Cell: F6

Normal distribution with parameters:

Mean 5.070
Std. Dev. 0.040

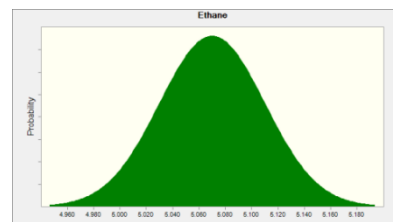

Assumption: Ethylbenzene

Cell: F19

Normal distribution with parameters:

Mean 0.197
Std. Dev. 0.018

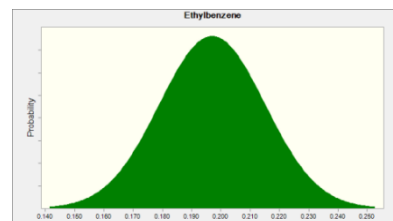

Assumption: Heptanes

Cell: F13

Normal distribution with parameters:

Mean 13.420
Std. Dev. 0.204

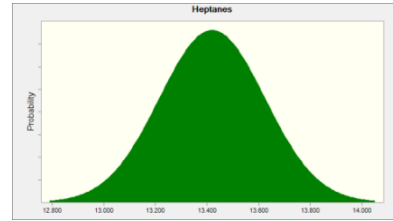

Assumption: Iso-Butane

Cell: F8

Normal distribution with parameters:

Mean 2.510
Std. Dev. 0.012

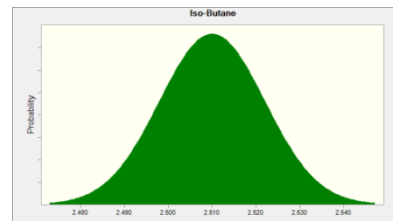

Assumption: Iso-Pentane

Cell: F10

Normal distribution with parameters:

Mean 5.310
Std. Dev. 0.062

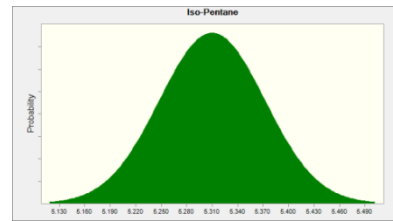

Assumption: m,p-Xylene (100% meta)

Cell: F20

Normal distribution with parameters:

Mean 2.310
Std. Dev. 0.030

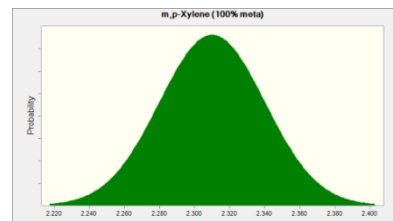

Assumption: Methane

Cell: F5

Normal distribution with parameters:

Mean

4.570

Std. Dev.

0.050

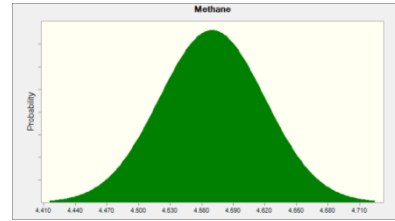

Assumption: n-Butane

Cell: F9

Normal distribution with parameters:

Mean

7.910

Std. Dev.

0.041

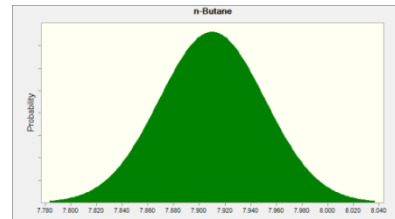

Assumption: n-Hexane

Cell: F12

Normal distribution with parameters:

Mean

6.370

Std. Dev.

0.138

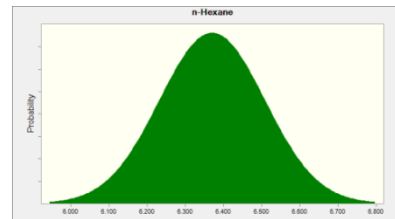

Assumption: Nonanes

Cell: F15

Normal distribution with parameters:

Mean

4.540

Std. Dev.

0.058

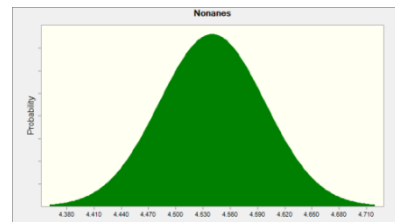

Assumption: n-Pentane

Cell: F11

Normal distribution with parameters:

Mean 7.415
Std. Dev. 0.031

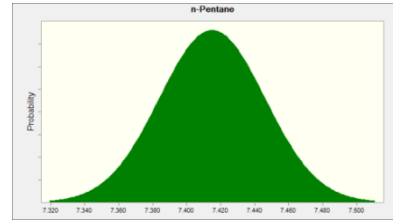

Assumption: Octanes

Cell: F14

Normal distribution with parameters:

Mean 10.339
Std. Dev. 0.338

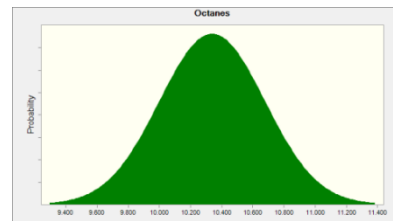

Assumption: o-Xylene

Cell: F21

Normal distribution with parameters:

Mean 0.525
Std. Dev. 0.007

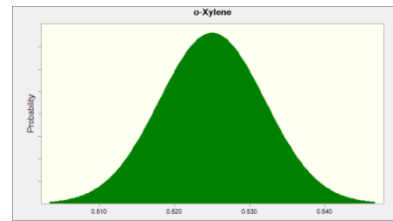

Assumption: Propane

Cell: F7

Normal distribution with parameters:

Mean 7.080
Std. Dev. 0.047

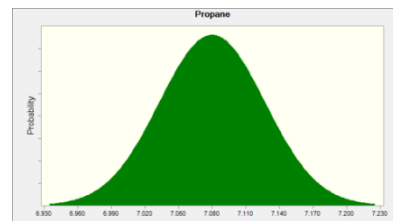

Assumption: Separator Pressure

Cell: S7

Uniform distribution with parameters:

Minimum 186.30
Maximum 194.16

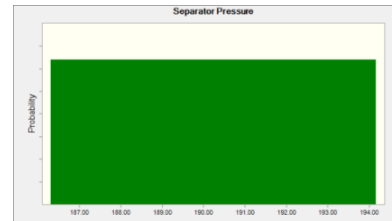

Assumption: Separator Temperature

Cell: S5

Uniform distribution with parameters:

Minimum 78.31
Maximum 82.29

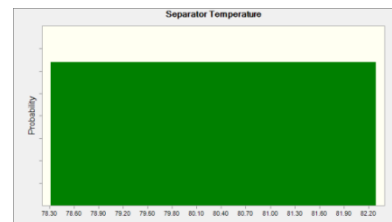

Assumption: Tank Bottom Pressure

Cell: S12

Normal distribution with parameters:

Mean 16.63
Std. Dev. 0.07

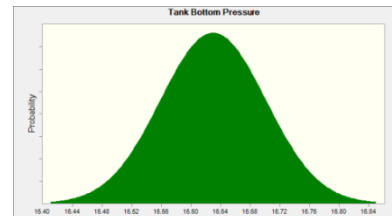

Assumption: Tank Bottom Temperature

Cell: S11

Uniform distribution with parameters:

Minimum 76.39
Maximum 79.41

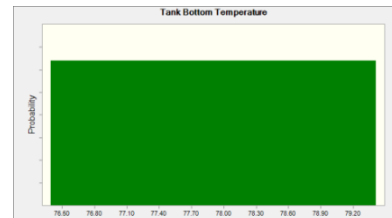

Assumption: Tank HS Pressure

Cell: S10

Uniform distribution with parameters:

Minimum 12.43
Maximum 12.67

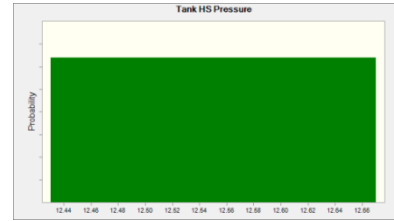

Assumption: Tank HS Temperature

Cell: S9

Uniform distribution with parameters:

Minimum 93.78
Maximum 97.82

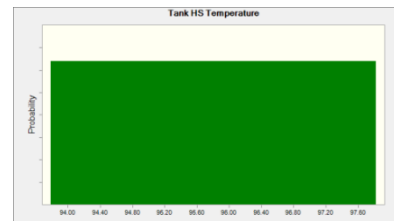

Assumption: Toluene

Cell: F18

Normal distribution with parameters:

Mean 2.950
Std. Dev. 0.033

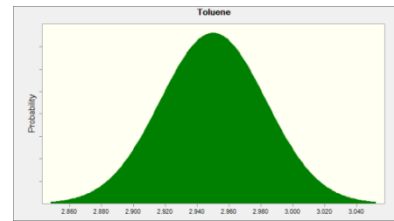

Assumption: Volume Flow (Std. Bbl)

Cell: F40

Normal distribution with parameters:

Mean 0.449
Std. Dev. 0.001

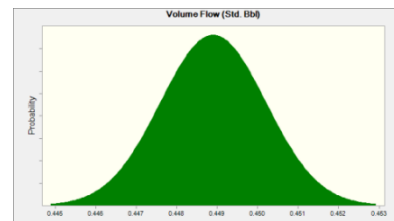

End of Assumptions

Crystal Ball Report - Full

Simulation started on 5/14/2017 at 7:26 PM

Simulation stopped on 5/15/2017 at 5:35 PM

Run preferences:

Number of trials run	3,000
Monte Carlo	
Random seed	
Precision control on	
Confidence level	95.00%

Run statistics:

Total running time (sec)	79694.70
Trials/second (average)	0
Random numbers per sec	1

Crystal Ball data:

Assumptions	32
Correlations	0
Correlated groups	0
Decision variables	0
Forecasts	4

Forecasts**Worksheet: [Excel_HYSYS_PHLA.xlsx]Input & Output****Forecast: Flash Gas to Oil Ratio (FGOR) - Standard (scf/bbl)****Cell: S34**

Summary:

Entire range is from 220.464 to 246.461

Base case is 233.455

After 3,000 trials, the std. error of the mean is 0.072

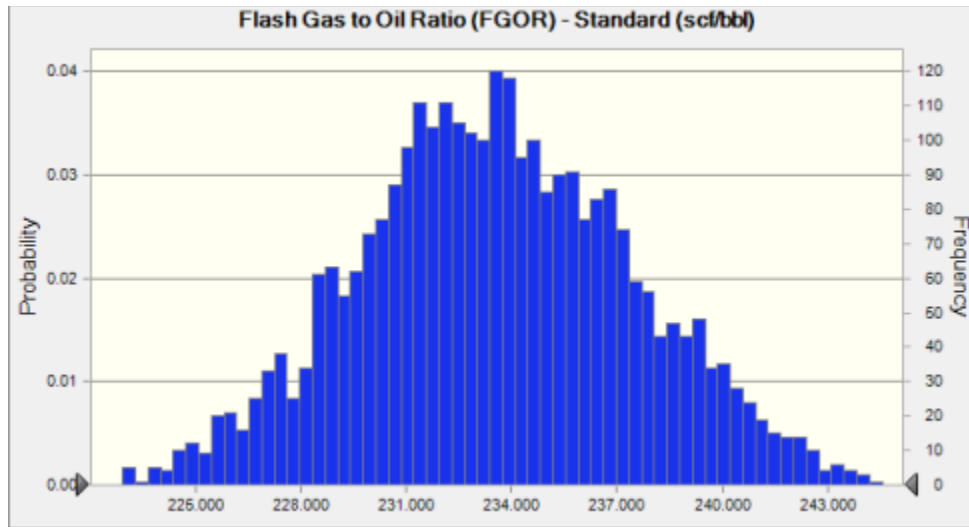

Statistics:	Forecast values
Trials	3,000
Base Case	233.455
Mean	233.564
Median	233.474
Mode	---
Standard Deviation	3.924
Variance	15.396
Skewness	0.0743
Kurtosis	2.77
Coeff. of Variability	0.0168
Minimum	220.464
Maximum	246.461
Range Width	25.997
Mean Std. Error	0.072

Forecast: Flash Gas to Oil Ratio (FGOR) - Standard (scf/bbl) (cont'd)

Cell: S34

Percentiles:	Forecast values
0%	220.464
10%	228.547
20%	230.319
30%	231.429
40%	232.432
50%	233.473
60%	234.445
70%	235.646
80%	236.918
90%	238.843
100%	246.461

Forecast: Flash MW

Cell: S29

Summary:

Entire range is from 41.627 to 42.768

Base case is 42.180

After 3,000 trials, the std. error of the mean is 0.003

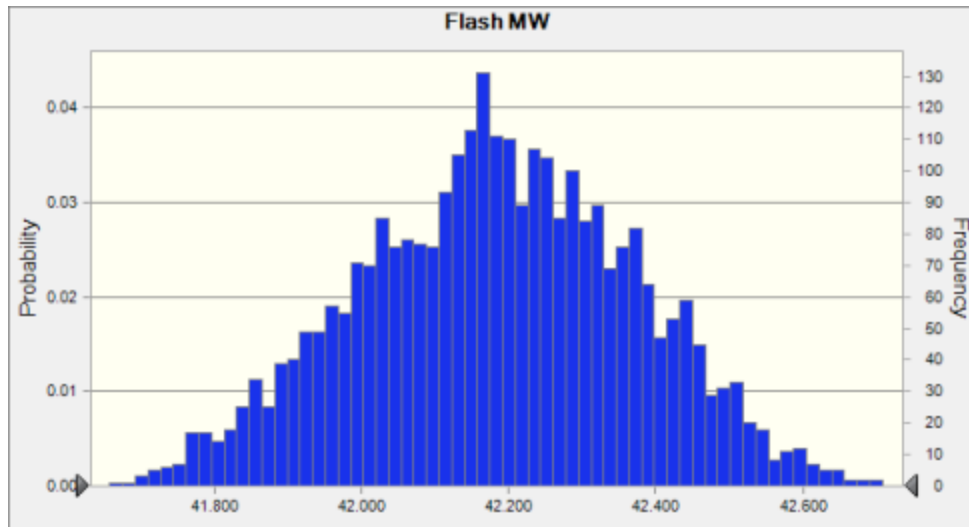

Statistics:	Forecast values
Trials	3,000
Base Case	42.180
Mean	42.183
Median	42.185
Mode	---
Standard Deviation	0.187
Variance	0.035
Skewness	-0.0603
Kurtosis	2.64
Coeff. of Variability	0.0044
Minimum	41.627
Maximum	42.768
Range Width	1.141
Mean Std. Error	0.003

Forecast: Flash MW (cont'd)

Cell: S29

Percentiles:	Forecast values
0%	41.627
10%	41.932
20%	42.018
30%	42.083
40%	42.141
50%	42.184
60%	42.234
70%	42.285
80%	42.349
90%	42.430
100%	42.768

Forecast: Sample Bubble Point at Tsep

Cell: S6

Summary:

Entire range is from 174.48 to 193.63

Base case is 182.99

After 3,000 trials, the std. error of the mean is 0.05

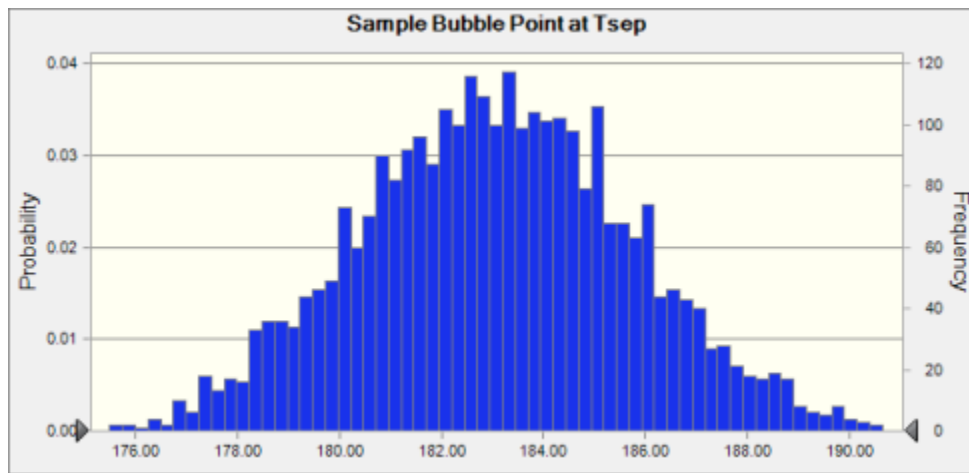

Statistics:	Forecast values
Trials	3,000
Base Case	182.99
Mean	183.07
Median	183.05
Mode	---
Standard Deviation	2.70
Variance	7.30
Skewness	0.0785
Kurtosis	2.97
Coeff. of Variability	0.0148
Minimum	174.48
Maximum	193.63
Range Width	19.15
Mean Std. Error	0.05

Forecast: Sample Bubble Point at Tsep (cont'd)

Cell: S6

Percentiles:	Forecast values
0%	174.48
10%	179.57
20%	180.78
30%	181.60
40%	182.38
50%	183.05
60%	183.73
70%	184.48
80%	185.31
90%	186.49
100%	193.63

Forecast: Shrinkage Factor

Cell: S37

Summary:

Entire range is from 0.875 to 0.888
 Base case is 0.882
 After 3,000 trials, the std. error of the mean is 0.000

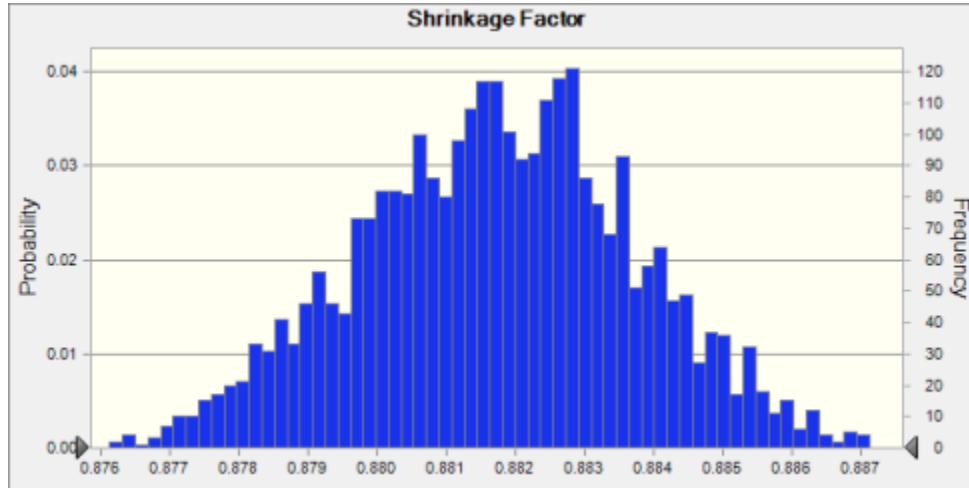

Statistics:	Forecast values
Trials	3,000
Base Case	0.882
Mean	0.882
Median	0.882
Mode	---
Standard Deviation	0.002
Variance	0.000
Skewness	-0.0567
Kurtosis	2.73
Coeff. of Variability	0.0023
Minimum	0.875
Maximum	0.888
Range Width	0.013
Mean Std. Error	0.000

Forecast: Shrinkage Factor (cont'd)

Cell: S37

Percentiles:	Forecast values
0%	0.875
10%	0.879
20%	0.880
30%	0.881
40%	0.881
50%	0.882
60%	0.882
70%	0.883
80%	0.883
90%	0.884
100%	0.888

End of Forecasts

Assumptions

Worksheet: [Excel_HYSYS_PHLA.xlsx]Input & Output

Assumption: 2,2,4-Trime thylpenta ne

Cell: F22

Normal distribution with parameters:

Mean 0.055
Std. Dev. 0.000

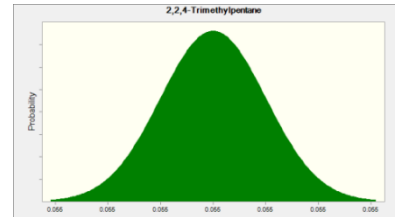

Assumption: 2,2-Dimethylbutane

Cell: F23

Normal distribution with parameters:

Mean 0.051
Std. Dev. 0.000

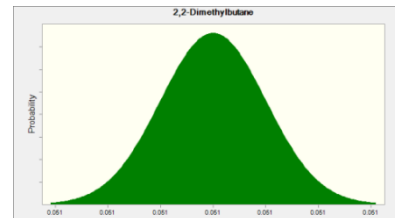

Assumption: 2,3-Dimethylbutane

Cell: F24

Normal distribution with parameters:

Mean 0.180
Std. Dev. 0.000

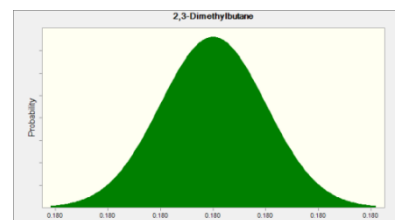

Assumption: 2-Methylpentane

Cell: F26

Normal distribution with parameters:

Mean 1.330
Std. Dev. 0.002

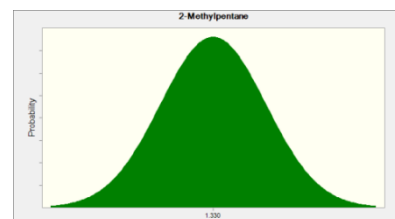

Assumption: 3-Methylpentane

Cell: F27

Normal distribution with parameters:

Mean

0.768

Std. Dev.

0.001

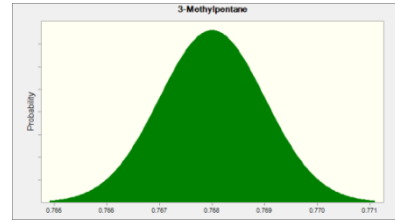

Assumption: Benzene

Cell: F17

Normal distribution with parameters:

Mean

0.328

Std. Dev.

0.006

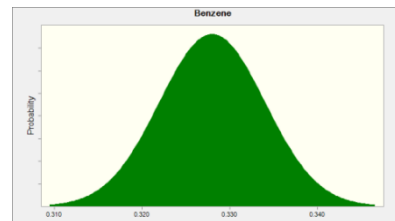

Assumption: Carbon Dioxide

Cell: F3

Normal distribution with parameters:

Mean

0.337

Std. Dev.

0.010

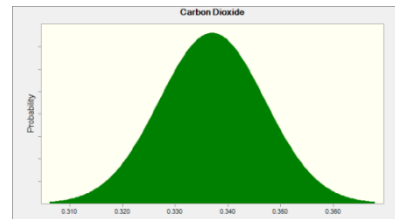

Assumption: Cyclopentane

Cell: F25

Normal distribution with parameters:

Mean

0.218

Std. Dev.

0.000

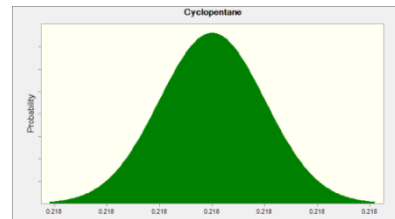

Assumption: Decanes Plus

Cell: F16

Normal distribution with parameters:

Mean 27.409
 Std. Dev. 0.434

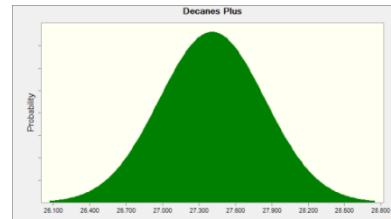

Assumption: Discharge Through Siphon Hole (fraction, 0-1)

Cell: S8

Uniform distribution with parameters:

Minimum 0.04
 Maximum 0.08

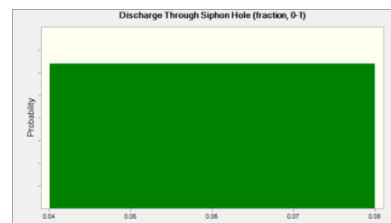

Assumption: Ethane

Cell: F6

Normal distribution with parameters:

Mean 5.090
 Std. Dev. 0.036

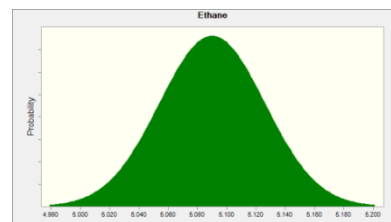

Assumption: Ethylbenzene

Cell: F19

Normal distribution with parameters:

Mean 0.120
 Std. Dev. 0.009

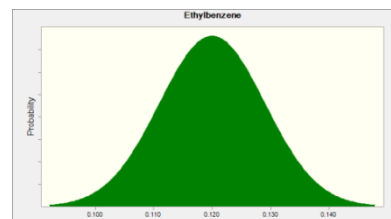

Assumption: Heptanes

Cell: F13

Normal distribution with parameters:

Mean 11.692
Std. Dev. 0.066

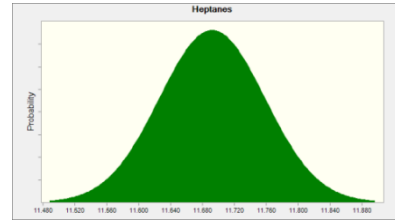

Assumption: Iso-Butane

Cell: F8

Normal distribution with parameters:

Mean 2.530
Std. Dev. 0.013

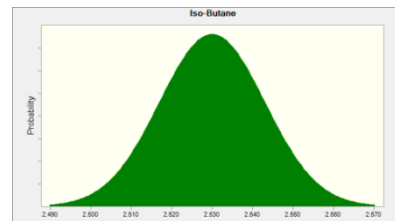

Assumption: Iso-Pentane

Cell: F10

Normal distribution with parameters:

Mean 5.270
Std. Dev. 0.091

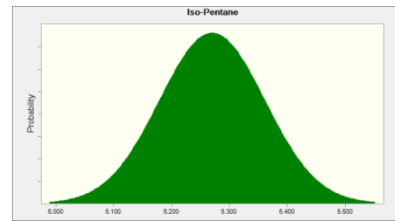

Assumption: m,p-Xylene (100% meta)

Cell: F20

Normal distribution with parameters:

Mean 1.330
Std. Dev. 0.009

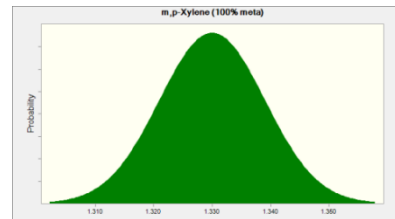

Assumption: Methane

Cell: F5

Normal distribution with parameters:

Mean 4.550
Std. Dev. 0.082

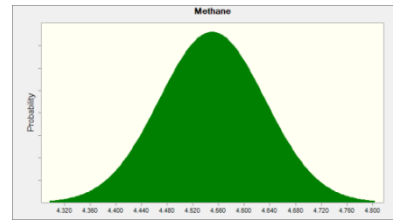

Assumption: n-Butane

Cell: F9

Normal distribution with parameters:

Mean 8.110
Std. Dev. 0.032

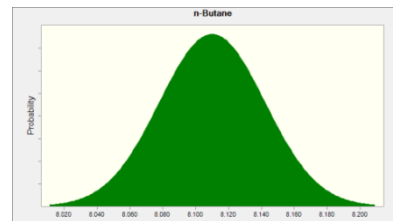

Assumption: n-Hexane

Cell: F12

Normal distribution with parameters:

Mean 2.350
Std. Dev. 0.010

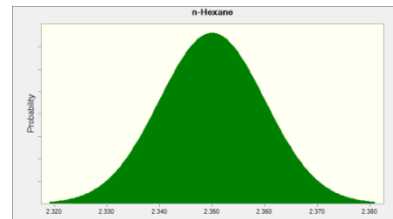

Assumption: Nonanes

Cell: F15

Normal distribution with parameters:

Mean 3.220
Std. Dev. 0.049

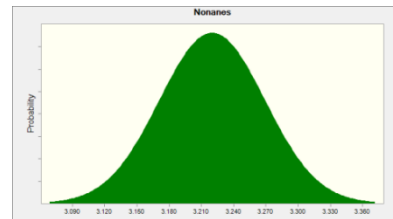

Assumption: n-Pentane

Cell: F11

Normal distribution with parameters:

Mean

7.340

Std. Dev.

0.027

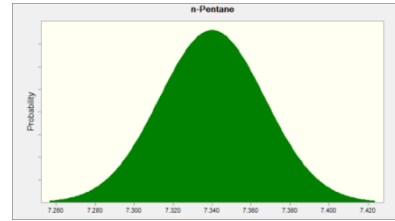

Assumption: Octanes

Cell: F14

Normal distribution with parameters:

Mean

8.960

Std. Dev.

0.185

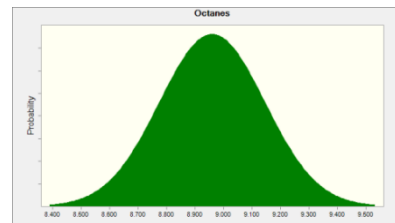

Assumption: o-Xylene

Cell: F21

Normal distribution with parameters:

Mean

0.257

Std. Dev.

0.002

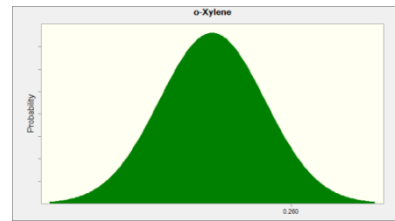

Assumption: Propane

Cell: F7

Normal distribution with parameters:

Mean

7.055

Std. Dev.

0.057

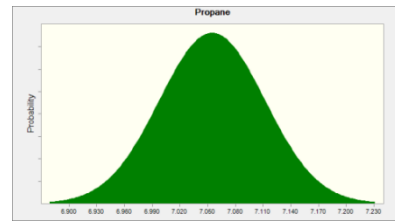

Assumption: Separator Pressure

Cell: S7

Uniform distribution with parameters:

Minimum 186.30
Maximum 194.16

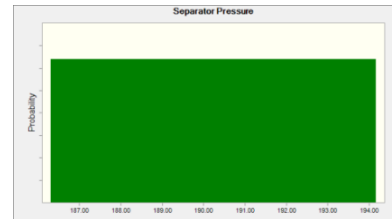

Assumption: Separator Temperature

Cell: S5

Uniform distribution with parameters:

Minimum 78.31
Maximum 82.29

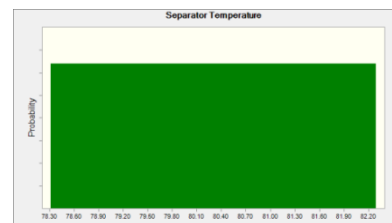

Assumption: Tank Bottom Pressure

Cell: S12

Normal distribution with parameters:

Mean 16.63
Std. Dev. 0.07

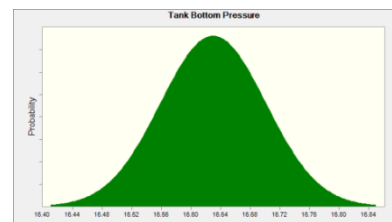

Assumption: Tank Bottom Temperature

Cell: S11

Uniform distribution with parameters:

Minimum 76.39
Maximum 79.41

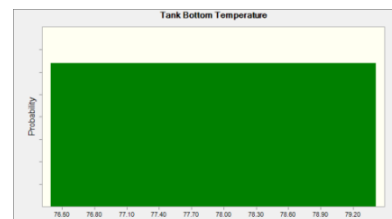

Assumption: Tank HS Pressure

Cell: S10

Uniform distribution with parameters:

Minimum 12.43
Maximum 12.67

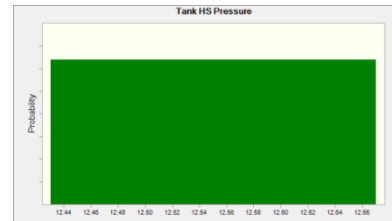

Assumption: Tank HS Temperature

Cell: S9

Uniform distribution with parameters:

Minimum 93.78
Maximum 97.82

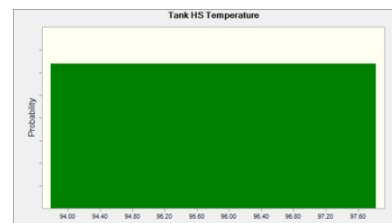

Assumption: Toluene

Cell: F18

Normal distribution with parameters:

Mean 1.450
Std. Dev. 0.009

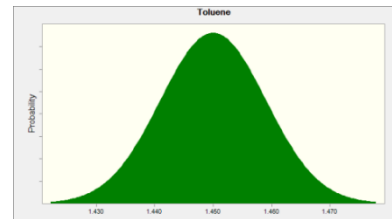

Assumption: Volume Flow (Std. Bbl)

Cell: F40

Normal distribution with parameters:

Mean 0.449
Std. Dev. 0.001

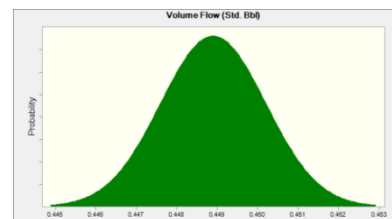

End of Assumptions